

Commercial Fittings and Fixtures

List Price Guide – April 1, 2023



American Standard

Commercial Fittings

Ultima® Manual and Selectronic® Diaphragm Flush Valves

DynaClean® Self-Cleaning Technology Helps Prevent Valve Run-On Due to Clogging

Reduce Maintenance and Downtime, Save Water

CLOG-REDUCING TECHNOLOGY AND MORE

These diaphragm flush valves offer a common-sense solution to the all-too-common problem of valve run-on caused by clogging.

SUPERIOR PERFORMANCE AND DURABILITY

These flush valves include our exclusive self-cleaning technology and superior materials to out-perform and out-last traditional diaphragm flush valves

PROPRIETARY BRASS ALLOY

prevents dezincification

ADA-COMPLIANT non-hold open handle provides automatic shut-off after every flush

HIGH BACK PRESSURE VACUUM BREAKER

prevents dripping

SWEAT SOLDER KIT included

5-YEAR LIMITED WARRANTY

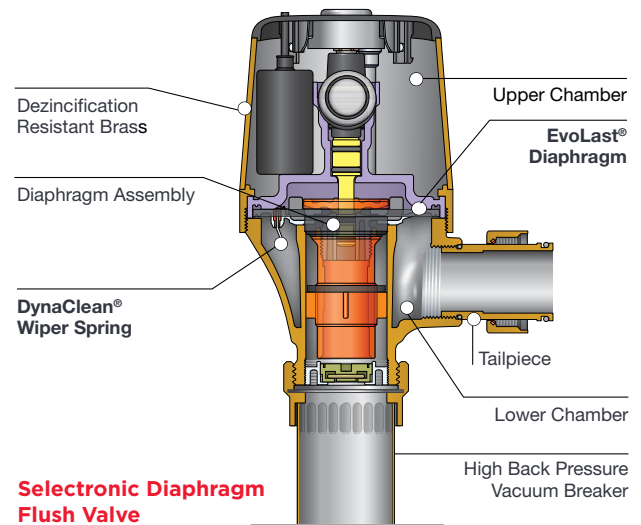
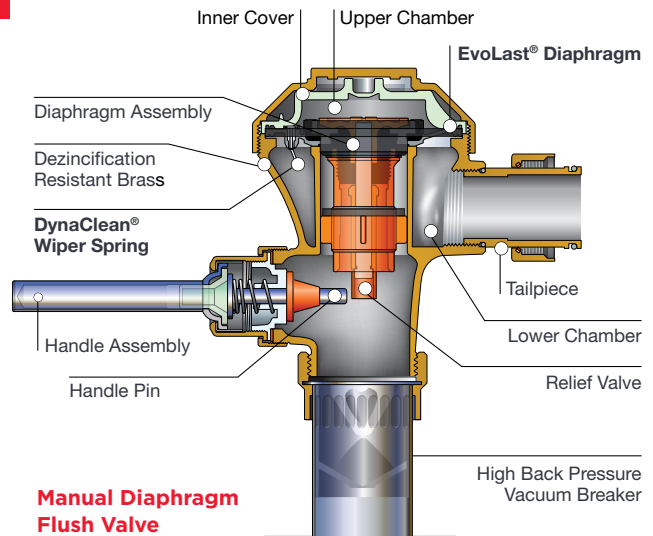

DynaClean Wiper Spring

DYNACLEAN, our exclusive, self-cleaning technology, cleans the refill orifice with every flush, and help prevent valve run-on. The integral wiper spring keeps the orifice clear of debris and mineral build-up for improved performance and less maintenance.

EASY RETROFIT, ENHANCED PERFORMANCE

Ultima Flush Valves are easy to retrofit in place of most popular piston and diaphragm flush valves. The industry standard rough-in dimensions allow for an easy switch.

Ultima Diaphragm Assemblies can be installed in diaphragm flush valves from other major manufacturers, making it easy to improve performance and ensure reliability in existing applications.



EvoLast Diaphragm

EVOLAST, a premium, chlorine-resistant diaphragm material delivers consistent performance and resists premature deterioration and failure.

American Standard Commercial Products

Commercial Fittings

Ultima® Manual and Selectronic® Diaphragm Flush Valves

Selectronic® Piston Flush Valves

Paradigm® Selectronic® Faucets

Water Conservation Without Compromise

Powerful Things Happen...

Icons

Commercial Toilet and Urinal Flush Valve Systems

Commercial Fittings

Commercial Fittings Overview

Lavatory Faucets

Touchless Faucet/Soap Dispenser

Touchless Sensor-Operated Foam Soap Dispenser

Clean IR® Touchless Faucets

Paradigm® Selectronic® Integrated Faucets

NextGen Selectronic® Integrated Faucets

Serin® Sensor-Operated Lavatory Faucets

Selectronic® Touchless Faucets

Selectronic® IC Touchless Faucets

Innsbrook® Selectronic® Touchless Faucets

Moments® Selectronic® Touchless Faucets

Commercial Faucet Accessories

Selectronic® Power Kits and Accessories

Metering Lavatory Faucets and Accessories

Monterrey® Lavatory Faucets

Kitchen Faucets

Heritage® Pantry Faucet

Monterrey® Kitchen Faucets

Lavatory Faucets and Bath/Shower Trim Kits

Reliant 3® Lavatory Faucets and Bath/Shower Trim Kits

Commercial Shower System Kits and Components

Commercial Service Sink Faucets

Commercial and Institutional Fittings

Continued on next page.



American Standard FAST ATTACK Service Team
(844) CRT- TEAM / 844-278-8326
CRTTEAM@lixilamericas.com
www.americanstandard.com/crt

Commercial Fittings Continued

Flush Valves and Flush Valve Accessories

Ultima® Selectronic® Diaphragm Type Flush Valves
Ultima® Sensor-Operated Diaphragm Type Flush Valves
Ultima® Manual Diaphragm Type Flush Valves
Ultima® Selectronic® Piston Type Flush Valves
Ultima® Manual Piston Type Flush Valves
Bedpan Washers Accessories
Flush Valve Accessories
Shower Valve Accessories
Sink Drains and Faucet Accessories
Flow Controls
Commercial Faucet Modifications and Aerator Cross Reference

Commercial Fixtures

Back Outlet VorMax® HETs

Exceptional Performance

Commercial/Institutional Fixtures Overview

Sinks

Above Counter Bathroom Sinks
Under Counter Bathroom Sinks
Wall-Hung Bathroom Sinks
ICS Sink and Selectronic® IC Touchless Faucet
Institutional Fixtures/Service Sinks

Toilets

Baby Bowl Toilets
Flushometer Toilets
Gravity Flush Toilets
Pressure-Assisted Toilets
Two-Piece Toilet Platform
No-Touch Flush for Home and Business
Cadet® Touchless Toilets
VorMax® Toilets
Champion® PRO Toilets
Cadet® PRO Toilets

Optional Toilet Seats/Trip Levers/Toilet Tanks

Urinals

1-Pint Flush Urinals
High Efficiency Urinals
Low Consumption Urinals

Commercial Parts

Warranties



American Standard FAST ATTACK Service Team
(844) CRT- TEAM / 844-278-8326
CRTTEAM@lixilamericas.com
www.americanstandard.com/crt

Commercial Fittings

Manual and Selectronic® Diaphragm Flush Valves

Durable, dezincification-resistant brass construction outside and clog-resistant technology inside ensure on-site dependability and a significant reduction in maintenance, even in the most demanding locations.



Urinal Flush Valves



Washbrook® Urinal
shown with Ultima® Manual
Diaphragm Flush Valve



6145 Series
Manual Urinal Flush Valves
(0.125, 0.5 and 1.0 gpf)*



6245 Series
Selectronic Urinal Flush Valves
(0.125, 0.5 and 1.0 gpf)*

Toilet Flush Valves



Madera™ Toilet shown with
Ultima Manual Diaphragm
Flush Valve



6147 Series
Manual Toilet Flush Valves
(1.1, 1.28 and 1.6 gpf)*



6247 Series
Selectronic Toilet Flush Valves
(1.1, 1.28/1.1 gpf Dual Flush
and 1.6 gpf)*

Clinic Sink Flush Valves are also available.

*WaterSense for 0.125 gpf and 0.5 gpf urinals and 1.1 gpf and 1.28 gpf toilets only.

Commercial Fittings

Selectronic® Flush Valves

PWRX 10-Year Life Battery System reduces the downtime and maintenance costs associated with changing batteries.

Advanced lithium battery and circuitry delivers 10-year battery life

Lasts 2.5 times longer than standard flush valve batteries

Self-cleaning piston reduces clogging and maintenance.
DynaClean® wiper spring cleans the refill orifice with every flush to help prevent run-on

Dezincification resistant brass alloy
Resists corrosion in harsh water conditions

Fully mechanical manual override can flush the valve without power

High Back Pressure Vacuum Breaker prevents leakage from vacuum breaker vents

Chemical-resistant EPDM seals for extended life

5-Year Limited Warranty – including PWRX battery

No routine maintenance required.
No diaphragm to replace, no filter seen to clean

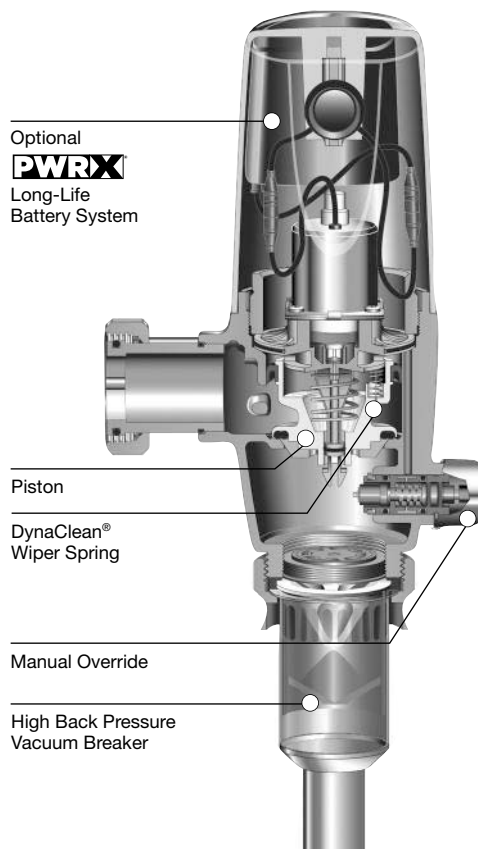

Paradigm® Selectronic Faucets

SmarTherm® Safety Shut-Off
Integral thermostatic hot water temperature limiter meets ASSE 1070 without a separate thermostatic mixing valve

Clean, Integrated Design

- All electronics contained in faucet spout
- No control box below deck

Easy Installation and Maintenance

- Faucet installs from the top
- All serviceable parts are easily accessible

Flow Rate Options (All vandal-resistant)

- 0.35 and 0.5 gpm multi-laminar spray
- 1.5 gpm laminar flow outlet with adjustable spray face

Above-Deck Mixing

- Allows user to manually adjust temperature
- Adjustable hot limit stop
- Red and blue indicators

Removable Mixing Handle

- Installer can set temperature and remove handle to prevent user adjustment
- Cover plug included

Hygienic, touch-free operation

Flexible Selectronic® Platform with programmable sensor and interchangeable power supplies

SmarTherm®

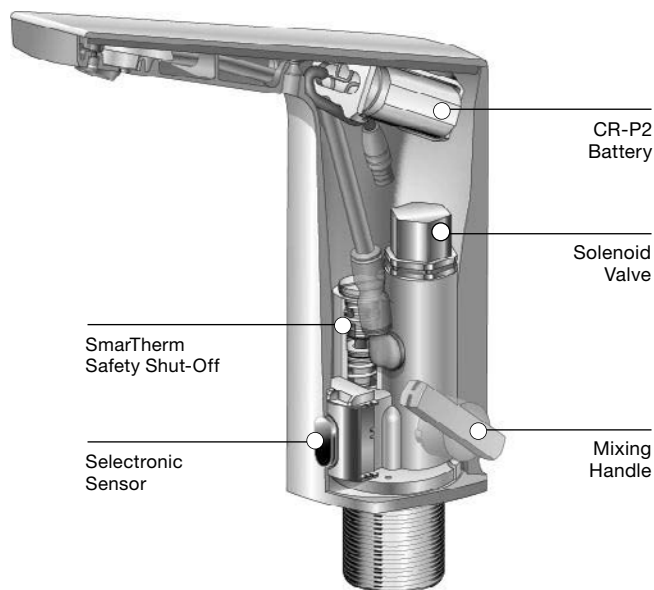

For more information on American Standard Brands, please visit our website at www.americanstandard.com or call 1-800-442-1902.

Commercial Fittings/Fixtures

Water Conservation Without Compromise

American Standard Offers a Full Range of Water Efficient Faucets, Showers, Toilets and Urinal

High Efficiency Toilets (HETs)



HETs use 1.28 gpf/4.8 Lpf or less on every flush. American Standard has the most maximum performance HET toilets of any manufacturer. WaterSense certified.



Champion® PRO Two-Piece



Cadet® PRO Two-Piece



Yorkville® Two-Piece Pressure Assist

High Efficiency Urinals (HEUs)



HEUs use 0.5 gpf/1.9 Lpf or less on every flush. WaterSense certified.



Washbrook®



Decorum®



Pintbrook®

WaterSense® Certified Faucets



All American Standard residential bathroom faucets, and some commercial faucets, are WaterSense certified for high performance and water efficiency. Meeting the Environmental Protection Agency's (EPA) strict WaterSense maximum flow rate requirement of 1.5 gpm/5.7 L/min, these American Standard lavatory faucets incorporate pressure-compensating aerators that deliver a minimum of 32% water savings over standard models without sacrificing performance. WaterSense certified.



NextGen™ Selectronic® with SmarTherm®



Paradigm®



Monterrey®



Reliant 3®



This WaterSense label is your confirmation that the product has met the U.S. Environmental Protection Agency (EPA) criteria for exceptional performance while reducing water use by 20% or more.

WaterSense is a voluntary partnership program launched by the U.S. Environmental Protection Agency to designate product and services that conserve water and perform as intended. WaterSense is a registered trade/service mark of the EPA.

Commercial Fixtures/Fittings

Powerful Things Happen...

When your flush valve and toilet are designed together

Engineered systems from American Standard combine fixtures and flush valves that were designed together to deliver superior performance while using less water. They are backed by an extended 5-year warranty.

1.1 gpf/4.2 Lpf High Efficiency Afwall® Millennium® and Madera™ Toilet Systems

- 31% water savings when compared to standard 1.6 gpf/6.0 Lpf toilets
- 14% water savings when compared to 1.28 gpf/4.8 Lpf toilets
- Maximum MaP Score: 1,000 grams of miso at 1.1 – 1.6 gpf (4.2 – 6.0 Lpf)
- Self-cleaning piston valve with DynaClean® integral wiper spring helps prevent clogging and reduces maintenance
- Available with DC (Battery) or Manual Flush Valves
- All toilets available with EverClean® Antimicrobial Surface



Madera with
Selectronic®
Battery Powered
Flush Valve



Afwall Millennium
with Manual
Flush Valve



Washbrook® with
Selectronic Battery
Powered Flush Valve

0.125 gpf/0.5 Lpf High Efficiency Urinal Systems

- 87.5% water savings when compared to standard 1.0 gpf/3.8 Lpf urinals
- Superior dilution of urine minimizes odor
- Self-cleaning piston valve with DynaClean integral wiper spring helps prevent clogging and reduces maintenance
- Flow regulator on the flush valve outlet maintains constant flush volume regardless of inlet pressure
- DC (Battery) or Manual Flush Valves are available

For more information on American Standard Brands, please visit our website at www.americanstandard.com or call 1-800-442-1902.

Icons

Look for these symbols throughout our **List Price Guide** to quickly identify key information and important features of our products. Each symbol is prominently displayed to make your purchasing decision easier and ensure your choice of product meets your requirements.

 NEW	New product or feature introduced for 2023.
 PREMIER	Premier product by American Standard.
 MAP	All products displaying this symbol are protected by American Standard's Unilateral Suggested Minimum Advertised Price Program (USMAP). All UMAP protected products contained within this publication are subject to change. For additional information see UMAP Policy section with the Distributor Support Programs.
 ADA COMPLIANT	Meets the Americans with Disabilities Act guidelines and ANSI A117.1 requirements for accessible and usable building facilities – check local codes.
 CALIFORNIA ENERGY COMMISSION	Meets California Energy Commission requirements.
 EPA WATERSENSE CERTIFIED	WaterSense® Certified. Meets all ANSI/ ASME low consumption, water conservation requirements.

✦ Check your local codes to determine if 1.6 gpf/6.0 Lpf toilets are allowed in your area.

CALGreen® is a registered trademark of California Building Standards Commission.

Images throughout the price guide are for illustrative purposes only—actual features may vary.

Toilet and Selectronic® Flush Valve Systems



Madera™ Chair Height EverClean® Toilet System With Touchless Selectronic® Piston Flush Valve, 1.6 gpf/6.0 Lpf

- Maximum 1,000 gram MaP Score
- Elongated floor mount flushometer bowl, top spud, less seat
- 16-½" (419 mm) rim height for accessible application
- Static weight load of 2,500 lbs (1,134 kg)
- Permanent EverClean® surface inhibits the growth of stain and odor-causing bacteria, mold, and mildew on the surface
- Touchless piston-operated flush valve
- 8-year CR-P2 lithium battery installed in valve
- Exclusive DynaClean® self-cleaning wiper spring technology
- Integral wiper spring cleans refill orifice with every flush to help prevent valve run-on
- Fully mechanical manual override can operate without power



Description	SKU	Color	List Price
Madera™ Chair Height EverClean® Toilet System With Touchless Selectronic® Piston Flush Valve, 1.6 gpf/6.0 Lpf	3461660.020	White	733

Separate Components:

Madera™ 1.1 – 1.6 gpf (4.2 – 6.0 Lpf) Chair Height Top Spud Elongated EverClean® Bowl	3461001.020	White	
Ultima™ Selectronic Touchless Toilet Flush Valve, Piston-Type, Battery, 1.6 gpf/6.0 Lpf	6065161.002	Polished Chrome	



Madera™ 15-Inch EverClean® Toilet System With Touchless Selectronic® Piston Flush Valve, 1.6 gpf/6.0 Lpf

- Maximum 1,000 gram MaP Score
- Elongated floor mount flushometer bowl, top spud, less seat
- 15" (381 mm) rim height
- Permanent EverClean® surface inhibits the growth of stain and odor-causing bacteria, mold, and mildew on the surface
- Touchless piston-operated flush valve
- 8-year CR-P2 lithium battery installed in valve
- Exclusive DynaClean® self-cleaning wiper spring technology
- Integral wiper spring cleans refill orifice with every flush to help prevent valve run-on
- Fully mechanical manual override can operate without power

Description	SKU	Color	List Price
Madera™ 15-Inch EverClean® Toilet System With Touchless Selectronic® Piston Flush Valve, 1.6 gpf/6.0 Lpf	3451660.020	White	700

Separate Components:

Madera™ 1.1 – 1.6 gpf (4.2 – 6.0 Lpf) 15" Height Top Spud Elongated EverClean® Bowl	3451001.020	White	
Ultima™ Selectronic Touchless Toilet Flush Valve, Piston-Type, Battery, 1.6 gpf/6.0 Lpf	6065161.002	Polished Chrome	



Madera™ Chair Height Toilet System With Touchless Selectronic® Piston Flush Valve, 1.6 gpf/6.0 Lpf

- Maximum 1,000 gram MaP Score
- Elongated floor mount flushometer bowl, top spud, less seat
- 16-½" (419 mm) rim height for accessible application
- Static weight load of 2,500 lbs (1,134 kg)
- Touchless piston-operated flush valve
- 8-year CR-P2 lithium battery installed in valve
- Exclusive DynaClean® self-cleaning wiper spring technology
- Integral wiper spring cleans refill orifice with every flush to help prevent valve run-on
- Fully mechanical manual override can operate without power



Description	SKU	Color	List Price
Madera™ Chair Height Toilet System With Touchless Selectronic® Piston Flush Valve, 1.6 gpf/6.0 Lpf	3043660.020	White	703

Separate Components:

Madera™ 1.1 – 1.6 gpf (4.2 – 6.0 Lpf) Chair Height Top Spud Elongated Bowl	3043001.020	White	
Ultima™ Selectronic Touchless Toilet Flush Valve, Piston-Type, Battery, 1.6 gpf/6.0 Lpf	6065161.002	Polished Chrome	

Toilet and Selectronic® Flush Valve Systems



Madera™ 15-Inch Toilet System With Touchless Selectronic® Piston Flush Valve, 1.6 gpf/6.0 Lpf

- Maximum 1,000 gram MaP Score
- Elongated floor mount flushometer bowl, top spud, less seat
- 15" (381 mm) rim height
- Conventional glaze
- Touchless piston-operated flush valve
- 8-year CR-P2 lithium battery installed in valve
- Exclusive DynaClean® self-cleaning wiper spring technology
- Integral wiper spring cleans refill orifice with every flush to help prevent valve run-on
- Fully mechanical manual override can operate without power

Description	SKU	Color	List Price
Madera™ 15-Inch Toilet System With Touchless Selectronic® Piston Flush Valve, 1.6 gpf/6.0 Lpf	2234660.020	White	671

Separate Components:

Madera™ 1.1 – 1.6 gpf (4.2 – 6.0 Lpf) 15" Height Top Spud Elongated Bowl	2234001.020	White	
Ultima™ Selectronic Touchless Toilet Flush Valve, Piston-Type, Battery, 1.6 gpf/6.0 Lpf	6065161.002	Polished Chrome	



Afwall® Millennium® Wall-Hung EverClean® Toilet System With Touchless Selectronic® Piston Flush Valve, 1.6 gpf/6.0 Lpf

- Maximum 1,000 gram MaP Score
- Elongated wall-hung flushometer bowl, top spud, less seat
- Static weight load of 1,000 lbs (453 kg). Not recommended for bariatric use
- Permanent EverClean® surface inhibits the growth of stain and odor-causing bacteria, mold, and mildew on the surface
- Touchless piston-operated flush valve
- 8-year CR-P2 lithium battery installed in valve
- Exclusive DynaClean® self-cleaning wiper spring technology
- Integral wiper spring cleans refill orifice with every flush to help prevent valve run-on
- Fully mechanical manual override can operate without power



Description	SKU	Color	List Price
Afwall® Millennium® Wall-Hung EverClean® Toilet System With Touchless Selectronic® Piston Flush Valve, 1.6 gpf/6.0 Lpf	3351660.020	White	700

Separate Components:

Afwall® Millennium® 1.1 – 1.6 gpf (4.2 – 6.0 Lpf) Top Spud Elongated Wall-Hung EverClean® Bowl	3351101.020	White	
Ultima™ Selectronic Touchless Toilet Flush Valve, Piston-Type, Battery, 1.6 gpf/6.0 Lpf	6065161.002	Polished Chrome	



Afwall® Millennium® Wall-Hung Toilet System With Touchless Selectronic® Piston Flush Valve, 1.6 gpf/6.0 Lpf

- Maximum 1,000 gram MaP Score
- Elongated wall-hung flushometer bowl, top spud, less seat
- Static weight load of 1,000 lbs (453 kg). Not recommended for bariatric use
- Conventional glaze
- Touchless piston-operated flush valve
- 8-year CR-P2 lithium battery installed in valve
- Exclusive DynaClean® self-cleaning wiper spring technology
- Integral wiper spring cleans refill orifice with every flush to help prevent valve run-on
- Fully mechanical manual override can operate without power



Description	SKU	Color	List Price
Afwall® Millennium® Wall-Hung Toilet System With Touchless Selectronic® Piston Flush Valve, 1.6 gpf/6.0 Lpf	2257660.020	White	671

Separate Components:

Afwall® Millennium® 1.1 – 1.6 gpf (4.2 – 6.0 Lpf) Top Spud Elongated Wall-Hung Bowl	2257101.020	White	
Ultima™ Selectronic Touchless Toilet Flush Valve, Piston-Type, Battery, 1.6 gpf/6.0 Lpf	6065161.002	Polished Chrome	

Toilet and Selectronic® Flush Valve Systems



Madera™ Chair Height EverClean® Toilet System With Touchless Selectronic® Piston Flush Valve, 1.28 gpf/4.8 Lpf

- Maximum 1,000 gram MaP Score
- Elongated floor mount flushometer bowl, top spud, less seat
- 16-½" (419 mm) rim height for accessible application
- Static weight load of 2,500 lbs (1,134 kg)
- Permanent EverClean® surface inhibits the growth of stain and odor-causing bacteria, mold, and mildew on the surface
- Touchless piston-operated flush valve
- 8-year CR-P2 lithium battery installed in valve
- Exclusive DynaClean® self-cleaning wiper spring technology
- Integral wiper spring cleans refill orifice with every flush to help prevent valve run-on
- Fully mechanical manual override can operate without power



Description	SKU	Color	List Price
Madera™ Chair Height EverClean® Toilet System With Touchless Selectronic® Piston Flush Valve, 1.28 gpf/4.8 Lpf	3461528.020	White	733

Separate Components:

Madera™ 1.1 – 1.6 gpf (4.2 – 6.0 Lpf) Chair Height Top Spud Elongated EverClean® Bowl	3461001.020	White	
Ultima™ Selectronic Touchless Toilet Flush Valve, Piston-Type, Battery, 1.28 gpf/4.8 Lpf	6065121.002	Polished Chrome	



Madera™ 15-Inch EverClean® Toilet System With Touchless Selectronic® Piston Flush Valve, 1.28 gpf/4.8 Lpf

- Maximum 1,000 gram MaP Score
- Elongated floor mount flushometer bowl, top spud, less seat
- 15" (381 mm) rim height
- Permanent EverClean® surface inhibits the growth of stain and odor-causing bacteria, mold, and mildew on the surface
- Touchless piston-operated flush valve
- 8-year CR-P2 lithium battery installed in valve
- Exclusive DynaClean® self-cleaning wiper spring technology
- Integral wiper spring cleans refill orifice with every flush to help prevent valve run-on
- Fully mechanical manual override can operate without power



Description	SKU	Color	List Price
Madera™ 15-Inch EverClean® Toilet System With Touchless Selectronic® Piston Flush Valve, 1.28 gpf/4.8 Lpf	3451528.020	White	700

Separate Components:

Madera™ 1.1 – 1.6 gpf (4.2 – 6.0 Lpf) 15" Height Top Spud Elongated EverClean® Bowl	3451001.020	White	
Ultima™ Selectronic Touchless Toilet Flush Valve, Piston-Type, Battery, 1.28 gpf/4.8 Lpf	6065121.002	Polished Chrome	



Madera™ Chair Height Toilet System With Touchless Selectronic® Piston Flush Valve, 1.28 gpf/4.8 Lpf

- Maximum 1,000 gram MaP Score
- Elongated floor mount flushometer bowl, top spud, less seat
- 16-½" rim height for accessible application
- Static weight load of 2,500 lbs (1,134 kg)
- Touchless piston-operated flush valve
- 8-year CR-P2 lithium battery installed in valve
- Exclusive DynaClean® self-cleaning wiper spring technology
- Integral wiper spring cleans refill orifice with every flush to help prevent valve run-on
- Fully mechanical manual override can operate without power



Description	SKU	Color	List Price
Madera™ Chair Height Toilet System With Touchless Selectronic® Piston Flush Valve, 1.28 gpf/4.8 Lpf	3043528.020	White	692

Separate Components:

Madera™ 1.1 – 1.6 gpf (4.2 – 6.0 Lpf) Chair Height Top Spud Elongated Bowl	3043001.020	White	
Ultima™ Manual Toilet Flush Valve, Piston-Type, 1.28 gpf/4.8 Lpf	6047121.002	Polished Chrome	
Ultima™ Selectronic Touchless Toilet Flush Valve, Piston-Type, Battery, 1.28 gpf/4.8 Lpf	6065121.002	Polished Chrome	

Toilet and Selectronic® Flush Valve Systems



Madera™ 15-Inch Toilet System With Touchless Selectronic® Piston Flush Valve, 1.28 gpf/4.8 Lpf

- Maximum 1,000 gram MaP Score
- Elongated floor mount flushometer bowl, top spud, less seat
- 15" (381 mm) rim height
- Conventional glaze
- Touchless piston-operated flush valve
- 8-year CR-P2 lithium battery installed in valve
- Exclusive DynaClean® self-cleaning wiper spring technology
- Integral wiper spring cleans refill orifice with every flush to help prevent valve run-on
- Fully mechanical manual override can operate without power



Description	SKU	Color	List Price
Madera™ 15-Inch Toilet System With Touchless Selectronic® Piston Flush Valve, 1.28 gpf/4.8 Lpf	2234528.020	White	671

Separate Components:

Madera™ 1.1 – 1.6 gpf (4.2 – 6.0 Lpf) 15" Height Top Spud Elongated Bowl	2234001.020	White	
Ultima™ Selectronic Touchless Toilet Flush Valve, Piston-Type, Battery, 1.28 gpf/4.8 Lpf	6065121.002	Polished Chrome	



Afwall® Millennium® Wall-Hung EverClean® Toilet System With Touchless Selectronic® Piston Flush Valve, 1.28 gpf/4.8 Lpf

- Maximum 1,000 gram MaP Score
- Elongated wall-hung flushometer bowl, top spud, less seat
- Static weight load of 1,000 lbs (453 kg). Not recommended for bariatric use
- Permanent EverClean® surface inhibits the growth of stain and odor-causing bacteria, mold, and mildew on the surface
- Touchless piston-operated flush valve
- 8-year CR-P2 lithium battery installed in valve
- Exclusive DynaClean® self-cleaning wiper spring technology
- Integral wiper spring cleans refill orifice with every flush to help prevent valve run-on
- Fully mechanical manual override can operate without power



Description	SKU	Color	List Price
Afwall® Millennium® Wall-Hung EverClean® Toilet System With Touchless Selectronic® Piston Flush Valve, 1.28 gpf/4.8 Lpf	3351528.020	White	700

Separate Components:

Afwall® Millennium® 1.1 – 1.6 gpf (4.2 – 6.0 Lpf) Top Spud Elongated Wall-Hung EverClean® Bowl	3351101.020	White	
Ultima™ Selectronic Touchless Toilet Flush Valve, Piston-Type, Battery, 1.28 gpf/4.8 Lpf	6065121.002	Polished Chrome	



Afwall® Millennium® Wall-Hung Toilet System With Touchless Selectronic® Piston Flush Valve, 1.28 gpf/4.8 Lpf

- Maximum 1,000 gram MaP Score
- Elongated wall-hung flushometer bowl, top spud, less seat
- Static weight load of 1,000 lbs (453 kg). Not recommended for bariatric use
- Conventional glaze
- Touchless piston-operated flush valve
- 8-year CR-P2 lithium battery installed in valve
- Exclusive DynaClean® self-cleaning wiper spring technology
- Integral wiper spring cleans refill orifice with every flush to help prevent valve run-on
- Fully mechanical manual override can operate without power



Description	SKU	Color	List Price
Afwall® Millennium® Wall-Hung Toilet System With Touchless Selectronic® Piston Flush Valve, 1.28 gpf/4.8 Lpf	2257528.020	White	671

Separate Components:

Afwall® Millennium® 1.1 – 1.6 gpf (4.2 – 6.0 Lpf) Top Spud Elongated Wall-Hung Bowl	2257101.020	White	
Ultima™ Selectronic Touchless Toilet Flush Valve, Piston-Type, Battery, 1.28 gpf/4.8 Lpf	6065121.002	Polished Chrome	

Toilet and Selectronic® Flush Valve Systems



Madera™ Chair Height EverClean® Toilet System With Touchless Selectronic® Piston Flush Valve, DF 1.6/1.1 gpf (6.0/4.2 Lpf)

- Maximum 1,000 gram MaP Score
- Elongated floor mount flushometer bowl, top spud, less seat
- 16-½" (419 mm) rim height for accessible application
- Static weight load of 2,500 lbs (1,134 kg)
- Permanent EverClean® surface inhibits the growth of stain and odor-causing bacteria, mold, and mildew on the surface
- Touchless piston-operated flush valve
- 8-year CR-P2 lithium battery installed in valve
- Exclusive DynaClean® self-cleaning wiper spring technology
- Integral wiper spring cleans refill orifice with every flush to help prevent valve run-on
- Fully mechanical manual override can operate without power



Description	SKU	Color	List Price
Madera™ Chair Height EverClean® Toilet System With Touchless Selectronic® Piston Flush Valve, DF 1.6/1.1 gpf (6.0/4.2 Lpf)	3461576.020	White	733

Separate Components:

Madera™ 1.1 – 1.6 gpf (4.2 – 6.0 Lpf) Chair Height Top Spud Elongated EverClean® Bowl	3461001.020	White	
Ultima™ Selectronic Touchless Toilet Flush Valve, Piston-Type, Battery, Dual Flush 1.6/ 1.1 gpf (6.0/4.2 Lpf)	6065761.002	Polished Chrome	



Madera™ 15-Inch EverClean® Toilet System With Touchless Selectronic® Piston Flush Valve, DF 1.6 / 1.1 gpf (6.0/4.2 Lpf)

- Maximum 1,000 gram MaP Score
- Elongated floor mount flushometer bowl, top spud, less seat
- 15" (381 mm) rim height
- Permanent EverClean® surface inhibits the growth of stain and odor-causing bacteria, mold, and mildew on the surface
- Touchless piston-operated flush valve
- 8-year CR-P2 lithium battery installed in valve
- Exclusive DynaClean® self-cleaning wiper spring technology
- Integral wiper spring cleans refill orifice with every flush to help prevent valve run-on
- Fully mechanical manual override can operate without power



Description	SKU	Color	List Price
Madera™ 15-Inch EverClean® Toilet System With Touchless Selectronic® Piston Flush Valve, DF 1.6 / 1.1 gpf (6.0/4.2 Lpf)	3451576.020	White	700

Separate Components:

Madera™ 1.1 – 1.6 gpf (4.2 – 6.0 Lpf) 15" Height Top Spud Elongated EverClean® Bowl	3451001.020	White	
Ultima™ Selectronic Touchless Toilet Flush Valve, Piston-Type, Battery, Dual Flush 1.6/ 1.1 gpf (6.0/4.2 Lpf)	6065761.002	Polished Chrome	

Toilet and Selectronic® Flush Valve Systems



Afwall® Millennium® Wall-Hung EverClean® Toilet System With Touchless Selectronic® Piston Flush Valve, DF 1.6/1.1 gpf (6.0/4.2 Lpf)

- Maximum 1,000 gram MaP Score
- Elongated wall-hung flushometer bowl, top spud, less seat
- Static weight load of 1,000 lbs (453 kg). Not recommended for bariatric use
- Permanent EverClean® surface inhibits the growth of stain and odor-causing bacteria, mold, and mildew on the surface
- Touchless piston-operated flush valve
- 8-year CR-P2 lithium battery installed in valve
- Exclusive DynaClean® self-cleaning wiper spring technology
- Integral wiper spring cleans refill orifice with every flush to help prevent valve run-on
- Fully mechanical manual override can operate without power



Description	SKU	Color	List Price
Afwall® Millennium® Wall-Hung EverClean® Toilet System With Touchless Selectronic® Piston Flush Valve, DF 1.6/1.1 gpf (6.0/4.2 Lpf)	3351576.020	White	700

Separate Components:

Afwall® Millennium® 1.1 – 1.6 gpf (4.2 – 6.0 Lpf) Top Spud Elongated Wall-Hung EverClean® Bowl	3351101.020	White	
Ultima™ Selectronic Touchless Toilet Flush Valve, Piston-Type, Battery, Dual Flush 1.6/ 1.1 gpf (6.0/4.2 Lpf)	6065761.002	Polished Chrome	



Madera™ Chair Height EverClean® Toilet System With Touchless Selectronic® Piston Flush Valve, 1.1 gpf/4.2 Lpf

- Maximum 1,000 gram MaP Score
- Elongated floor mount flushometer bowl, top spud, less seat
- 16-1/2" (419 mm) rim height for accessible application
- Static weight load of 2,500 lbs (1,134 kg)
- Permanent EverClean® surface inhibits the growth of stain and odor-causing bacteria, mold, and mildew on the surface
- Touchless piston-operated flush valve
- 8-year CR-P2 lithium battery installed in valve
- Exclusive DynaClean® self-cleaning wiper spring technology
- Integral wiper spring cleans refill orifice with every flush to help prevent valve run-on
- Fully mechanical manual override can operate without power



Description	SKU	Color	List Price
Madera™ Chair Height EverClean® Toilet System With Touchless Selectronic® Piston Flush Valve, 1.1 gpf/4.2 Lpf	3461511.020	White	747

Separate Components:

Madera™ 1.1 – 1.6 gpf (4.2 – 6.0 Lpf) Chair Height Top Spud Elongated EverClean® Bowl	3461001.020	White	
Ultima™ Selectronic Touchless Toilet Flush Valve, Piston-Type, Battery, 1.1 gpf/4.2 Lpf	6065111.002	Polished Chrome	

Toilet and Selectronic® Flush Valve Systems



Madera™ 15-Inch EverClean® Toilet System With Touchless Selectronic® Piston Flush Valve, 1.1 gpf/4.2 Lpf

- Maximum 1,000 gram MaP Score
- Elongated floor mount flushometer bowl, top spud, less seat
- 15" (381 mm) rim height
- Permanent EverClean® surface inhibits the growth of stain and odor-causing bacteria, mold, and mildew on the surface
- Touchless piston-operated flush valve
- 8-year CR-P2 lithium battery installed in valve
- Exclusive DynaClean® self-cleaning wiper spring technology
- Integral wiper spring cleans refill orifice with every flush to help prevent valve run-on
- Fully mechanical manual override can operate without power



Description	SKU	Color	List Price
Madera™ 15-Inch EverClean® Toilet System With Touchless Selectronic® Piston Flush Valve, 1.1 gpf/4.2 Lpf	3451511.020	White	720

Separate Components:

Madera™ 1.1 – 1.6 gpf (4.2 – 6.0 Lpf) 15" Height Top Spud Elongated EverClean® Bowl	3451001.020	White	
Ultima™ Selectronic Touchless Toilet Flush Valve, Piston-Type, Battery, 1.1 gpf/4.2 Lpf	6065111.002	Polished Chrome	



Madera™ Chair Height Toilet System With Touchless Selectronic® Piston Flush Valve, 1.1 gpf/4.2 Lpf

- Maximum 1,000 gram MaP Score
- Elongated floor mount flushometer bowl, top spud, less seat
- 16-½" (419 mm) rim height for accessible application
- Static weight load of 2,500 lbs (1,134 kg)
- Touchless piston-operated flush valve
- 8-year CR-P2 lithium battery installed in valve
- Exclusive DynaClean® self-cleaning wiper spring technology
- Integral wiper spring cleans refill orifice with every flush to help prevent valve run-on
- Fully mechanical manual override can operate without power



Description	SKU	Color	List Price
Madera™ Chair Height Toilet System With Touchless Selectronic® Piston Flush Valve, 1.1 gpf/4.2 Lpf	3043511.020	White	722

Separate Components:

Madera™ 1.1 – 1.6 gpf (4.2 – 6.0 Lpf) Chair Height Top Spud Elongated Bowl	3043001.020	White	
Ultima™ Selectronic Touchless Toilet Flush Valve, Piston-Type, Battery, 1.1 gpf/4.2 Lpf	6065111.002	Polished Chrome	



Madera™ 15-Inch Toilet System With Touchless Selectronic® Piston Flush Valve, 1.1 gpf/4.2 Lpf

- Maximum 1,000 gram MaP Score
- Elongated floor mount flushometer bowl, top spud, less seat
- 15" (381 mm) rim height
- Conventional glaze
- Touchless piston-operated flush valve
- 8-year CR-P2 lithium battery installed in valve
- Exclusive DynaClean® self-cleaning wiper spring technology
- Integral wiper spring cleans refill orifice with every flush to help prevent valve run-on
- Fully mechanical manual override can operate without power



Description	SKU	Color	List Price
Madera™ 15-Inch Toilet System With Touchless Selectronic® Piston Flush Valve, 1.1 gpf/4.2 Lpf	2234511.020	White	687

Separate Components:

Madera™ 1.1 – 1.6 gpf (4.2 – 6.0 Lpf) 15" Height Top Spud Elongated Bowl	2234001.020	White	
Ultima™ Selectronic Touchless Toilet Flush Valve, Piston-Type, Battery, 1.1 gpf/4.2 Lpf	6065111.002	Polished Chrome	

Toilet and Selectronic® Flush Valve Systems



Afwall® Millennium® Wall-Hung EverClean® Toilet System With Touchless Selectronic® Piston Flush Valve, 1.1 gpf/4.2 Lpf

- Maximum 1,000 gram MaP Score
- Elongated wall-hung flushometer bowl, top spud, less seat
- Static weight load of 1,000 lbs (453 kg). Not recommended for bariatric use
- Permanent EverClean® surface inhibits the growth of stain and odor-causing bacteria, mold, and mildew on the surface
- Touchless piston-operated flush valve
- 8-year CR-P2 lithium battery installed in valve
- Exclusive DynaClean® self-cleaning wiper spring technology
- Integral wiper spring cleans refill orifice with every flush to help prevent valve run-on
- Fully mechanical manual override can operate without power



Description	SKU	Color	List Price
Afwall® Millennium® Wall-Hung EverClean® Toilet System With Touchless Selectronic® Piston Flush Valve, 1.1 gpf/4.2 Lpf	3351511.020	White	700

Separate Components:

Afwall® Millennium® 1.1 – 1.6 gpf (4.2 – 6.0 Lpf) Top Spud Elongated Wall-Hung EverClean® Bowl	3351101.020	White	
Ultima™ Selectronic Touchless Toilet Flush Valve, Piston-Type, Battery, 1.1 gpf/4.2 Lpf	6065111.002	Polished Chrome	



Afwall® Millennium® Wall-Hung Toilet System With Touchless Selectronic® Piston Flush Valve, 1.1 gpf/4.2 Lpf

- Maximum 1,000 gram MaP Score
- Elongated wall-hung flushometer bowl, top spud, less seat
- Static weight load of 1,000 lbs (453 kg). Not recommended for bariatric use
- Conventional glaze
- Touchless piston-operated flush valve
- 8-year CR-P2 lithium battery installed in valve
- Exclusive DynaClean® self-cleaning wiper spring technology
- Integral wiper spring cleans refill orifice with every flush to help prevent valve run-on
- Fully mechanical manual override can operate without power



Description	SKU	Color	List Price
Afwall® Millennium® Wall-Hung Toilet System With Touchless Selectronic® Piston Flush Valve, 1.1 gpf/4.2 Lpf	2257511.020	White	671

Separate Components:

Afwall® Millennium® 1.1 – 1.6 gpf (4.2 – 6.0 Lpf) Top Spud Elongated Wall-Hung Bowl	2257101.020	White	
Ultima™ Selectronic Touchless Toilet Flush Valve, Piston-Type, Battery, 1.1 gpf/4.2 Lpf	6065111.002	Polished Chrome	

Toilet and Manual Flush Valve Systems



+



Madera™ Chair Height EverClean® Toilet System With Manual Piston Flush Valve, 1.6 gpf/6.0 Lpf

- Maximum 1,000 gram MaP Score
- Elongated floor mount flushometer bowl, top spud, less seat
- 16-½" (419 mm) rim height for accessible application
- Static weight load of 2,500 lbs (1,134 kg)
- Permanent EverClean® surface inhibits the growth of stain and odor-causing bacteria, mold, and mildew on the surface
- Condensation channel
- Manual piston-operated flush valve
- Exclusive DynaClean® self-cleaning wiper spring technology
- Integral wiper spring cleans refill orifice with every flush to help prevent valve run-on
- Non-hold open handle provides automatic shut-off



Description	SKU	Color	List Price
Madera™ Chair Height EverClean® Toilet System With Manual Piston Flush Valve, 1.6 gpf/6.0 Lpf	2854016.020	White	372

Separate Components:

Madera™ 1.1 – 1.6 gpf (4.2 – 6.0 Lpf) Chair Height Top Spud Elongated EverClean® Bowl	3461001.020	White	
Ultima™ Manual Toilet Flush Valve, Piston-Type, 1.6 gpf/6.0 Lpf	6047161.002	Polished Chrome	



+



Madera™ 15-Inch EverClean® Toilet System With Manual Piston Flush Valve, 1.6 gpf/6.0 Lpf

- Maximum 1,000 gram MaP Score
- Elongated floor mount flushometer bowl, top spud, less seat
- 15" (381 mm) rim height
- Permanent EverClean® surface inhibits the growth of stain and odor-causing bacteria, mold, and mildew on the surface
- Condensation channel
- Manual piston-operated flush valve
- Exclusive DynaClean® self-cleaning wiper spring technology
- Integral wiper spring cleans refill orifice with every flush to help prevent valve run-on
- Non-hold open handle provides automatic shut-off

Description	SKU	Color	List Price
Madera™ 15-Inch EverClean® Toilet System With Manual Piston Flush Valve, 1.6 gpf/6.0 Lpf	2855016.020	White	337

Separate Components:

Madera™ 1.1 – 1.6 gpf (4.2 – 6.0 Lpf) 15" Height Top Spud Elongated EverClean® Bowl	3451001.020	White	
Ultima™ Manual Toilet Flush Valve, Piston-Type, 1.6 gpf/6.0 Lpf	6047161.002	Polished Chrome	



+



Madera™ Chair Height Toilet System With Manual Piston Flush Valve, 1.6 gpf/6.0 Lpf

- Maximum 1,000 gram MaP Score
- Elongated floor mount flushometer bowl, top spud, less seat
- 16-½" (419 mm) rim height for accessible application
- Static weight load of 2,500 lbs (1,134 kg)
- Conventional glaze
- Condensation channel
- Manual piston-operated flush valve
- Exclusive DynaClean® self-cleaning wiper spring technology
- Integral wiper spring cleans refill orifice with every flush to help prevent valve run-on
- Non-hold open handle provides automatic shut-off



Description	SKU	Color	List Price
Madera™ Chair Height Toilet System With Manual Piston Flush Valve, 1.6 gpf/6.0 Lpf	2857016.020	White	340

Separate Components:

Madera™ 1.1 – 1.6 gpf (4.2 – 6.0 Lpf) Chair Height Top Spud Elongated Bowl	3043001.020	White	
Ultima™ Manual Toilet Flush Valve, Piston-Type, 1.6 gpf/6.0 Lpf	6047161.002	Polished Chrome	

Toilet and Manual Flush Valve Systems



Madera™ 15-Inch Toilet System With Manual Piston Flush Valve, 1.6 gpf/6.0 Lpf

- Maximum 1,000 gram MaP Score
- Elongated floor mount flushometer bowl, top spud, less seat
- Conventional glaze
- Condensation channel
- Manual piston-operated flush valve
- Exclusive DynaClean® self-cleaning wiper spring technology
- Integral wiper spring cleans refill orifice with every flush to help prevent valve run-on
- Non-hold open handle provides automatic shut-off

Description	SKU	Color	List Price
Madera™ 15-Inch Toilet System With Manual Piston Flush Valve, 1.6 gpf/6.0 Lpf	2858016.020	White	307

Separate Components:

Madera™ 1.1 – 1.6 gpf (4.2 – 6.0 Lpf) 15" Height Top Spud Elongated Bowl	2234001.020	White	
Ultima™ Manual Toilet Flush Valve, Piston-Type, 1.6 gpf/6.0 Lpf	6047161.002	Polished Chrome	



Afwall® Millennium® Wall-Hung EverClean® Toilet System With Manual Piston Flush Valve, 1.6 gpf/6.0 Lpf

- Maximum 1,000 gram MaP Score
- Elongated wall-hung flushometer bowl, top spud, less seat
- Static weight load of 1,000 lbs (453 kg). Not recommended for bariatric use
- Permanent EverClean® surface inhibits the growth of stain and odor-causing bacteria, mold, and mildew on the surface
- Condensation channel
- Manual piston-operated flush valve
- Exclusive DynaClean® self-cleaning wiper spring technology
- Integral wiper spring cleans refill orifice with every flush to help prevent valve run-on
- Non-hold open handle provides automatic shut-off



Description	SKU	Color	List Price
Afwall® Millennium® Wall-Hung EverClean® Toilet System With Manual Piston Flush Valve, 1.6 gpf/6.0 Lpf	2856016.020	White	336

Separate Components:

Afwall® Millennium® 1.1 – 1.6 gpf (4.2 – 6.0 Lpf) Top Spud Elongated Wall-Hung EverClean® Bowl	3351101.020	White	
Ultima™ Manual Toilet Flush Valve, Piston-Type, 1.6 gpf/6.0 Lpf	6047161.002	Polished Chrome	



Afwall® Millennium® Wall-Hung Toilet System With Manual Piston Flush Valve, 1.6 gpf/6.0 Lpf

- Maximum 1,000 gram MaP Score
- Elongated wall-hung flushometer bowl, top spud, less seat
- Static weight load of 1,000 lbs (453 kg). Not recommended for bariatric use
- Conventional glaze
- Condensation channel
- Manual piston-operated flush valve
- Exclusive DynaClean® self-cleaning wiper spring technology
- Integral wiper spring cleans refill orifice with every flush to help prevent valve run-on
- Non-hold open handle provides automatic shut-off



Description	SKU	Color	List Price
Afwall® Millennium® Wall-Hung Toilet System With Manual Piston Flush Valve, 1.6 gpf/6.0 Lpf	2859016.020	White	307

Separate Components:

Afwall® Millennium® 1.1 – 1.6 gpf (4.2 – 6.0 Lpf) Top Spud Elongated Wall-Hung Bowl	2257101.020	White	
Ultima™ Manual Toilet Flush Valve, Piston-Type, 1.6 gpf/6.0 Lpf	6047161.002	Polished Chrome	

Toilet and Manual Flush Valve Systems



Madera™ Chair Height EverClean® Toilet System With Manual Piston Flush Valve, 1.28 gpf/4.8 Lpf

- Maximum 1,000 gram MaP Score
- Elongated floor mount flushometer bowl, top spud, less seat
- 16-½" (419 mm) rim height for accessible application
- Static weight load of 2,500 lbs (1,134 kg)
- Permanent EverClean® surface inhibits the growth of stain and odor-causing bacteria, mold, and mildew on the surface
- Condensation channel
- Manual piston-operated flush valve
- Exclusive DynaClean® self-cleaning wiper spring technology
- Integral wiper spring cleans refill orifice with every flush to help prevent valve run-on
- Non-hold open handle provides automatic shut-off



Description	SKU	Color	List Price
Madera™ Chair Height EverClean® Toilet System With Manual Piston Flush Valve, 1.28 gpf/4.8 Lpf	2854128.020	White	372

Separate Components:

Madera™ 1.1 – 1.6 gpf (4.2 – 6.0 Lpf) Chair Height Top Spud Elongated EverClean® Bowl	3461001.020	White	
Ultima™ Manual Toilet Flush Valve, Piston-Type, 1.28 gpf/4.8 Lpf	6047121.002	Polished Chrome	



Madera™ 15-Inch EverClean® Toilet System With Manual Piston Flush Valve, 1.28 gpf/4.8 Lpf

- Maximum 1,000 gram MaP Score
- Elongated floor mount flushometer bowl, top spud, less seat
- 15" (381 mm) rim height
- Permanent EverClean® surface inhibits the growth of stain and odor-causing bacteria, mold, and mildew on the surface
- Condensation channel
- Manual piston-operated flush valve
- Exclusive DynaClean® self-cleaning wiper spring technology
- Integral wiper spring cleans refill orifice with every flush to help prevent valve run-on
- Non-hold open handle provides automatic shut-off



Description	SKU	Color	List Price
Madera™ 15-Inch EverClean® Toilet System With Manual Piston Flush Valve, 1.28 gpf/4.8 Lpf	2855128.020	White	337

Separate Components:

Madera™ 1.1 – 1.6 gpf (4.2 – 6.0 Lpf) 15" Height Top Spud Elongated EverClean® Bowl	3451001.020	White	
Ultima™ Manual Toilet Flush Valve, Piston-Type, 1.28 gpf/4.8 Lpf	6047121.002	Polished Chrome	



Madera™ Chair Height Toilet System With Manual Piston Flush Valve, 1.28 gpf/4.8 Lpf

- Maximum 1,000 gram MaP Score
- Elongated floor mount flushometer bowl, top spud, less seat
- 16-½" (419 mm) rim height for accessible application
- Static weight load of 2,500 lbs (1,134 kg)
- Conventional glaze
- Condensation channel
- Manual piston-operated flush valve
- Exclusive DynaClean® self-cleaning wiper spring technology
- Integral wiper spring cleans refill orifice with every flush to help prevent valve run-on
- Non-hold open handle provides automatic shut-off



Description	SKU	Color	List Price
Madera™ Chair Height Toilet System With Manual Piston Flush Valve, 1.28 gpf/4.8 Lpf	2857128.020	White	340

Separate Components:

Madera™ 1.1 – 1.6 gpf (4.2 – 6.0 Lpf) Chair Height Top Spud Elongated Bowl	3043001.020	White	
Ultima™ Manual Toilet Flush Valve, Piston-Type, 1.28 gpf/4.8 Lpf	6047121.002	Polished Chrome	

Toilet and Manual Flush Valve Systems



+



Madera™ 15-Inch Toilet System With Manual Piston Flush Valve, 1.28 gpf/4.8 Lpf

- Maximum 1,000 gram MaP Score
- Elongated floor mount flushometer bowl, top spud, less seat
- 15" (381 mm) rim height
- Conventional glaze
- Condensation channel
- Manual piston-operated flush valve
- Exclusive DynaClean® self-cleaning wiper spring technology
- Integral wiper spring cleans refill orifice with every flush to help prevent valve run-on
- Non-hold open handle provides automatic shut-off



Description	SKU	Color	List Price
Madera™ 15-Inch Toilet System With Manual Piston Flush Valve, 1.28 gpf/4.8 Lpf	2858128.020	White	307

Separate Components:

Madera™ 1.1 – 1.6 gpf (4.2 – 6.0 Lpf) 15" Height Top Spud Elongated Bowl	2234001.020	White	
Ultima™ Manual Toilet Flush Valve, Piston-Type, 1.28 gpf/4.8 Lpf	6047121.002	Polished Chrome	



Afwall® Millennium® Wall-Hung EverClean® Toilet System With Manual Piston Flush Valve, 1.28 gpf/4.8 Lpf

- Maximum 1,000 gram MaP Score
- Elongated wall-hung flushometer bowl, top spud, less seat
- Static weight load of 1,000 lbs (453 kg). Not recommended for bariatric use
- Permanent EverClean® surface inhibits the growth of stain and odor-causing bacteria, mold, and mildew on the surface
- Condensation channel
- Manual piston-operated flush valve
- Exclusive DynaClean® self-cleaning wiper spring technology
- Integral wiper spring cleans refill orifice with every flush to help prevent valve run-on
- Non-hold open handle provides automatic shut-off



Description	SKU	Color	List Price
Afwall® Millennium® Wall-Hung EverClean® Toilet System With Manual Piston Flush Valve, 1.28 gpf/4.8 Lpf	2856128.020	White	336

Separate Components:

Afwall® Millennium® 1.1 – 1.6 gpf (4.2 – 6.0 Lpf) Top Spud Elongated Wall-Hung EverClean® Bowl	3351101.020	White	
Ultima™ Manual Toilet Flush Valve, Piston-Type, 1.28 gpf/4.8 Lpf	6047121.002	Polished Chrome	



Afwall® Millennium® Wall-Hung Toilet System With Manual Piston Flush Valve, 1.28 gpf/4.8 Lpf

- Maximum 1,000 gram MaP Score
- Elongated wall-hung flushometer bowl, top spud, less seat
- Static weight load of 1,000 lbs (453 kg). Not recommended for bariatric use
- Conventional glaze
- Condensation channel
- Manual piston-operated flush valve
- Exclusive DynaClean® self-cleaning wiper spring technology
- Integral wiper spring cleans refill orifice with every flush to help prevent valve run-on
- Non-hold open handle provides automatic shut-off



Description	SKU	Color	List Price
Afwall® Millennium® Wall-Hung Toilet System With Manual Piston Flush Valve, 1.28 gpf/4.8 Lpf	2859128.020	White	307

Separate Components:

Afwall® Millennium® 1.1 – 1.6 gpf (4.2 – 6.0 Lpf) Top Spud Elongated Wall-Hung Bowl	2257101.020	White	
Ultima™ Manual Toilet Flush Valve, Piston-Type, 1.28 gpf/4.8 Lpf	6047121.002	Polished Chrome	

Toilet and Manual Flush Valve Systems



Madera™ Chair Height EverClean® Toilet System With Manual Piston Flush Valve, 1.1 gpf/4.2 Lpf

- Maximum 1,000 gram MaP Score
- Elongated floor mount flushometer bowl, top spud, less seat
- 16-½" (419 mm) rim height for accessible application
- Static weight load of 2,500 lbs (1,134 kg)
- Permanent EverClean® surface inhibits the growth of stain and odor-causing bacteria, mold, and mildew on the surface
- Condensation channel
- Manual piston-operated flush valve
- Exclusive DynaClean® self-cleaning wiper spring technology
- Integral wiper spring cleans refill orifice with every flush to help prevent valve run-on
- Non-hold open handle provides automatic shut-off



Description	SKU	Color	List Price
Madera™ Chair Height EverClean® Toilet System With Manual Piston Flush Valve, 1.1 gpf/4.2 Lpf	2854111.020	White	407

Separate Components:

Madera™ 1.1 – 1.6 gpf (4.2 – 6.0 Lpf) Chair Height Top Spud Elongated EverClean® Bowl	3461001.020	White	
Ultima™ Manual Toilet Flush Valve, Piston-Type, 1.1 gpf/4.2 Lpf	6047111.002	Polished Chrome	



Madera™ 15-Inch EverClean® Toilet System With Manual Piston Flush Valve, 1.1 gpf/4.2 Lpf

- Maximum 1,000 gram MaP Score
- Elongated floor mount flushometer bowl, top spud, less seat
- 15" (381 mm) rim height
- Permanent EverClean® surface inhibits the growth of stain and odor-causing bacteria, mold, and mildew on the surface
- Condensation channel
- Manual piston-operated flush valve
- Exclusive DynaClean® self-cleaning wiper spring technology
- Integral wiper spring cleans refill orifice with every flush to help prevent valve run-on
- Non-hold open handle provides automatic shut-off



Description	SKU	Color	List Price
Madera™ 15-Inch EverClean® Toilet System With Manual Piston Flush Valve, 1.1 gpf/4.2 Lpf	2855111.020	White	378

Separate Components:

Madera™ 1.1 – 1.6 gpf (4.2 – 6.0 Lpf) 15" Height Top Spud Elongated EverClean® Bowl	3451001.020	White	
Ultima™ Manual Toilet Flush Valve, Piston-Type, 1.1 gpf/4.2 Lpf	6047111.002	Polished Chrome	



Madera™ Chair Height Toilet System With Manual Piston Flush Valve, 1.1 gpf/4.2 Lpf

- Maximum 1,000 gram MaP Score
- Elongated floor mount flushometer bowl, top spud, less seat
- 16-½" rim height for accessible application
- Static weight load of 2,500 lbs (1,134 kg)
- Conventional glaze
- Condensation channel
- Manual piston-operated flush valve
- Exclusive DynaClean® self-cleaning wiper spring technology
- Integral wiper spring cleans refill orifice with every flush to help prevent valve run-on
- Non-hold open handle provides automatic shut-off



Description	SKU	Color	List Price
Madera™ Chair Height Toilet System With Manual Piston Flush Valve, 1.1 gpf/4.2 Lpf	2857111.020	White	381

Separate Components:

Madera™ 1.1 – 1.6 gpf (4.2 – 6.0 Lpf) Chair Height Top Spud Elongated Bowl	3043001.020	White	
Ultima™ Manual Toilet Flush Valve, Piston-Type, 1.1 gpf/4.2 Lpf	6047111.002	Polished Chrome	

Toilet and Manual Flush Valve Systems



+



Madera™ 15-Inch Toilet System With Manual Piston Flush Valve, 1.1 gpf/4.2 Lpf

- Maximum 1,000 gram MaP Score
- Elongated floor mount flushometer bowl, top spud, less seat
- 15" (381 mm) rim height
- Conventional glaze
- Condensation channel
- Manual piston-operated flush valve
- Exclusive DynaClean® self-cleaning wiper spring technology
- Integral wiper spring cleans refill orifice with every flush to help prevent valve run-on
- Non-hold open handle provides automatic shut-off



Description	SKU	Color	List Price
Madera™ 15-Inch Toilet System With Manual Piston Flush Valve, 1.1 gpf/4.2 Lpf	2858111.020	White	372

Separate Components:

Madera™ 1.1 – 1.6 gpf (4.2 – 6.0 Lpf) 15" Height Top Spud Elongated Bowl	2234001.020	White	
Ultima™ Manual Toilet Flush Valve, Piston-Type, 1.1 gpf/4.2 Lpf	6047111.002	Polished Chrome	



Afwall® Millennium® Wall-Hung EverClean® Toilet System With Manual Piston Flush Valve, 1.1 gpf/4.2 Lpf

- Maximum 1,000 gram MaP Score
- Elongated wall-hung flushometer bowl, top spud, less seat
- Static weight load of 1,000 lbs (453 kg). Not recommended for bariatric use
- Permanent EverClean® surface inhibits the growth of stain and odor-causing bacteria, mold, and mildew on the surface
- Condensation channel
- Manual piston-operated flush valve
- Exclusive DynaClean® self-cleaning wiper spring technology
- Integral wiper spring cleans refill orifice with every flush to help prevent valve run-on
- Non-hold open handle provides automatic shut-off



Description	SKU	Color	List Price
Afwall® Millennium® Wall-Hung EverClean® Toilet System With Manual Piston Flush Valve, 1.1 gpf/4.2 Lpf	2856111.020	White	379

Separate Components:

Afwall® Millennium® 1.1 – 1.6 gpf (4.2 – 6.0 Lpf) Top Spud Elongated Wall-Hung EverClean® Bowl	3351101.020	White	
Ultima™ Manual Toilet Flush Valve, Piston-Type, 1.1 gpf/4.2 Lpf	6047111.002	Polished Chrome	



Afwall® Millennium® Wall-Hung Toilet System With Manual Piston Flush Valve, 1.1 gpf/4.2 Lpf

- Maximum 1,000 gram MaP Score
- Elongated wall-hung flushometer bowl, top spud, less seat
- Static weight load of 1,000 lbs (453 kg). Not recommended for bariatric use
- Conventional glaze
- Condensation channel
- Manual piston-operated flush valve
- Exclusive DynaClean® self-cleaning wiper spring technology
- Integral wiper spring cleans refill orifice with every flush to help prevent valve run-on
- Non-hold open handle provides automatic shut-off



Description	SKU	Color	List Price
Afwall® Millennium® Wall-Hung Toilet System With Manual Piston Flush Valve, 1.1 gpf/4.2 Lpf	2859111.020	White	372

Separate Components:

Afwall® Millennium® 1.1 – 1.6 gpf (4.2 – 6.0 Lpf) Top Spud Elongated Wall-Hung Bowl	2257101.020	White	
Ultima™ Manual Toilet Flush Valve, Piston-Type, 1.1 gpf/4.2 Lpf	6047111.002	Polished Chrome	

Urinal and Selectronic® Flush Valve Systems



Washbrook® Urinal System With Touchless Selectronic® Piston Flush Valve, 1.0 gpf/3.8 Lpf

- Vitreous china construction
- Powerful washdown flushing action
- Extended side for privacy
- ¾" (19 mm) inlet spud with 2" (51 mm) outlet connection
- Wall hangers included
- Touchless piston-operated flush valve
- 8-year CR-P2 lithium battery installed in valve
- Exclusive DynaClean® self-cleaning wiper spring technology
- Integral wiper spring cleans refill orifice with every flush to help prevent valve run-on
- Fully mechanical manual override can operate without power



Description	SKU	Color	List Price
Washbrook® Urinal System With Touchless Selectronic® Piston Flush Valve, 1.0 gpf/3.8 Lpf	6501610.020	White	807

Separate Components:

Ultima™ Selectronic Touchless Urinal Flush Valve, Piston-Type, Battery, 1.0 gpf/3.8 Lpf	6063101.002	Polished Chrome	
Washbrook® 0.125 – 1.0 gpf (0.47 – 3.8 Lpf) Top Spud Urinal	6590001.020	White	



Washbrook® Urinal System With Touchless Selectronic® Piston Flush Valve, 0.5 gpf/1.9 Lpf

- Vitreous china construction
- Powerful washdown flushing action
- Extended side for privacy
- ¾" (19 mm) inlet spud with 2" (51 mm) outlet connection
- Wall hangers included
- Touchless piston-operated flush valve
- 8-year CR-P2 lithium battery installed in valve
- Exclusive DynaClean® self-cleaning wiper spring technology
- Integral wiper spring cleans refill orifice with every flush to help prevent valve run-on
- Fully mechanical manual override can operate without power



Description	SKU	Color	List Price
Washbrook® Urinal System With Touchless Selectronic® Piston Flush Valve, 0.5 gpf/1.9 Lpf	6590505.020	White	807

Separate Components:

Ultima™ Selectronic Touchless Urinal Flush Valve, Piston-Type, Battery, 0.5 gpf/1.9 Lpf	6063051.002	Polished Chrome	
Washbrook® 0.125 – 1.0 gpf (0.47 – 3.8 Lpf) Top Spud Urinal	6590001.020	White	



Washbrook® Urinal System With Touchless Selectronic® Piston Flush Valve, 0.125 gpf/0.5 Lpf

- Vitreous china construction
- Powerful washdown flushing action
- Extended side for privacy
- ¾" (19 mm) inlet spud with 2" (51 mm) outlet connection
- Wall hangers included
- Touchless piston-operated flush valve
- 8-year CR-P2 lithium battery installed in valve
- Exclusive DynaClean® self-cleaning wiper spring technology
- Integral wiper spring cleans refill orifice with every flush to help prevent valve run-on
- Fully mechanical manual override can operate without power



Description	SKU	Color	List Price
Washbrook® Urinal System With Touchless Selectronic® Piston Flush Valve, 0.125 gpf/0.5 Lpf	6590525.020	White	811

Separate Components:

Ultima™ Selectronic Touchless Urinal Flush Valve, Piston-Type, Battery, 0.125 gpf/0.5 Lpf	6063013.002	Polished Chrome	
Washbrook® 0.125 – 1.0 gpf (0.47 – 3.8 Lpf) Top Spud Urinal	6590001.020	White	

Urinal and Selectronic® Flush Valve Systems



Decorum® EverClean® Urinal System With Touchless Selectronic® Piston Flush Valve, 0.125 gpf/0.5 Lpf

- Sleek, modern, compact design
- Permanent EverClean® surface inhibits the growth of stain and odor-causing bacteria, mold, and mildew on the surface
- Powerful washdown flushing action with deep sump to reduce splashing
- ¾" (19 mm) inlet spud with 2" (51 mm) outlet connection
- Wall hangers included
- Touchless piston-operated flush valve
- 8-year CR-P2 lithium battery installed in valve
- Exclusive DynaClean® self-cleaning wiper spring technology
- Integral wiper spring cleans refill orifice with every flush to help prevent valve run-on
- Fully mechanical manual override can operate without power



Description	SKU	Color	List Price
Decorum® EverClean® Urinal System With Touchless Selectronic® Piston Flush Valve, 0.125 gpf/0.5 Lpf	6042633.020	White	764

Separate Components:

Decorum® 0.125 gpf/0.47 Lpf Top Spud Urinal With EverClean®	6042001EC.020	White	
Ultima™ Selectronic Touchless Urinal Flush Valve, Piston-Type, Battery, 0.125 gpf/0.5 Lpf	6063013.002	Polished Chrome	



Pintbrook® Urinal System With Touchless Selectronic® Piston Flush Valve, 0.5 gpf/1.9 Lpf

- Made in Mexico (USMCA compliant)
- Powerful washdown flushing action
- Optimized chinaware contours provide superior splash protection
- ¾" (19 mm) inlet spud with 2" (51 mm) outlet connection
- Wall hangers included
- Touchless piston-operated flush valve
- 8-year CR-P2 lithium battery installed in valve
- Exclusive DynaClean® self-cleaning wiper spring technology
- Integral wiper spring cleans refill orifice with every flush to help prevent valve run-on
- Fully mechanical manual override can operate without power



Description	SKU	Color	List Price
Pintbrook® Urinal System With Touchless Selectronic® Piston Flush Valve, 0.5 gpf/1.9 Lpf	6002505.020	White	732

Separate Components:

Pintbrook® 0.125 – 0.5 gpf (0.47 – 1.9 Lpf) Top Spud Urinal	6002001.020	White	
Ultima™ Selectronic Touchless Urinal Flush Valve, Piston-Type, Battery, 0.5 gpf/1.9 Lpf	6063051.002	Polished Chrome	



Pintbrook® Urinal System With Touchless Selectronic® Piston Flush Valve, 0.125 gpf/0.5 Lpf

- Made in Mexico (USMCA compliant)
- Powerful washdown flushing action
- Optimized chinaware contours provide superior splash protection
- ¾" (19 mm) inlet spud with 2" (51 mm) outlet connection
- Wall hangers included
- Touchless piston-operated flush valve
- 8-year CR-P2 lithium battery installed in valve
- Exclusive DynaClean® self-cleaning wiper spring technology
- Integral wiper spring cleans refill orifice with every flush to help prevent valve run-on
- Fully mechanical manual override can operate without power



Description	SKU	Color	List Price
Pintbrook® Urinal System With Touchless Selectronic® Piston Flush Valve, 0.125 gpf/0.5 Lpf	6002525.020	White	732

Separate Components:

Pintbrook® 0.125 – 0.5 gpf (0.47 – 1.9 Lpf) Top Spud Urinal	6002001.020	White	
Ultima™ Selectronic Touchless Urinal Flush Valve, Piston-Type, Battery, 0.125 gpf/0.5 Lpf	6063013.002	Polished Chrome	

Urinal and Manual Flush Valve Systems



+



Washbrook® Urinal System with Manual Piston Flush Valve, 1.0 gpf/3.8 Lpf

- Vitreous china construction
- Powerful washdown flushing action
- Extended side for privacy
- ¾" (19 mm) inlet spud with 2" (51 mm) outlet connection
- Wall hangers included
- Manual piston-operated flush valve
- Exclusive DynaClean® self-cleaning wiper spring technology
- Integral wiper spring cleans refill orifice with every flush to help prevent valve run-on
- Non-hold open handle provides automatic shut-off



Description	SKU	Color	List Price
Washbrook® Urinal System with Manual Piston Flush Valve, 1.0 gpf/3.8 Lpf	6501511.020	White	449

Separate Components:

Ultima™ Manual Urinal Flush Valve, Piston-Type, 1.0 gpf/3.8 Lpf	6045101.002	Polished Chrome	
Washbrook® 0.125 – 1.0 gpf (0.47 – 3.8 Lpf) Top Spud Urinal	6590001.020	White	



+



Washbrook® Urinal System with Manual Piston Flush Valve, 0.5 gpf/1.9 Lpf

- Vitreous china construction
- Powerful washdown flushing action
- Extended side for privacy
- ¾" (19 mm) inlet spud with 2" (51 mm) outlet connection
- Wall hangers included
- Manual piston-operated flush valve
- Exclusive DynaClean® self-cleaning wiper spring technology
- Integral wiper spring cleans refill orifice with every flush to help prevent valve run-on
- Non-hold open handle provides automatic shut-off



Description	SKU	Color	List Price
Washbrook® Urinal System with Manual Piston Flush Valve, 0.5 gpf/1.9 Lpf	6590501.020	White	449

Separate Components:

Ultima™ Manual Urinal Flush Valve, Piston-Type, 0.5 gpf/1.9 Lpf	6045051.002	Polished Chrome	
Washbrook® 0.125 – 1.0 gpf (0.47 – 3.8 Lpf) Top Spud Urinal	6590001.020	White	



+



Washbrook® Urinal System with Manual Piston Flush Valve, 0.125 gpf/0.5 Lpf

- Vitreous china construction
- Powerful washdown flushing action
- Extended side for privacy
- ¾" (19 mm) inlet spud with 2" (51 mm) outlet connection
- Wall hangers included
- Manual piston-operated flush valve
- Exclusive DynaClean® self-cleaning wiper spring technology
- Integral wiper spring cleans refill orifice with every flush to help prevent valve run-on
- Non-hold open handle provides automatic shut-off



Description	SKU	Color	List Price
Washbrook® Urinal System with Manual Piston Flush Valve, 0.125 gpf/0.5 Lpf	6590503.020	White	449

Separate Components:

Ultima™ Manual Urinal Flush Valve, Piston-Type, 0.125 gpf/0.5 Lpf	6045013.002	Polished Chrome	
Washbrook® 0.125 – 1.0 gpf (0.47 – 3.8 Lpf) Top Spud Urinal	6590001.020	White	

Urinal and Manual Flush Valve Systems



Decorum® EverClean® Urinal System With Manual Piston Flush Valve, 0.125 gpf/0.5 Lpf

- Sleek, modern, compact design
- Permanent EverClean® surface inhibits the growth of stain and odor-causing bacteria, mold, and mildew on the surface
- Powerful washdown action with deep sump that helps reduce splashing
- ¾" (19 mm) inlet spud with 2" (51 mm) outlet connection
- Wall hangers included
- Manual piston-operated flush valve
- Exclusive DynaClean® self-cleaning wiper spring technology
- Integral wiper spring cleans refill orifice with every flush to help prevent valve run-on
- Non-hold open handle provides automatic shut-off



Description	SKU	Color	List Price
Decorum® EverClean® Urinal System With Manual Piston Flush Valve, 0.125 gpf/0.5 Lpf	6042453.020	White	378

Separate Components:

Decorum® 0.125 gpf/0.47 Lpf Top Spud Urinal With EverClean®	6042001EC.020	White	
Ultima™ Manual Urinal Flush Valve, Piston-Type, 0.125 gpf/0.5 Lpf	6045013.002	Polished Chrome	



Pintbrook® Urinal System With Manual Piston Flush Valve, 0.5 gpf/1.9 Lpf

- High Efficiency Urinal (HEU) operates in the range of 0.125 gpf – 0.5 gpf (0.47 Lpf – 1.9 Lpf)
- Powerful washdown flushing action
- Optimized chinaware contours provide superior splash protection
- ¾" (19 mm) inlet spud with 2" (51 mm) outlet connection
- Wall hanger included
- Manual piston-operated flush valve
- Exclusive DynaClean® self-cleaning wiper spring technology
- Integral wiper spring cleans refill orifice with every flush to help prevent valve run-on
- Non-hold open handle provides automatic shut-off



Description	SKU	Color	List Price
Pintbrook® Urinal System With Manual Piston Flush Valve, 0.5 gpf/1.9 Lpf	6002501.020	White	377

Separate Components:

Pintbrook® 0.125 – 0.5 gpf (0.47 – 1.9 Lpf) Top Spud Urinal	6002001.020	White	
Ultima™ Manual Urinal Flush Valve, Piston-Type, 0.5 gpf/1.9 Lpf	6045051.002	Polished Chrome	



Pintbrook® Urinal System With Manual Piston Flush Valve, 0.125 gpf/0.5 Lpf

- High Efficiency Urinal (HEU) operates in the range of 0.125 gpf – 0.5 gpf (0.47 Lpf – 1.9 Lpf)
- Powerful washdown flushing action
- Optimized chinaware contours provide superior splash protection
- ¾" (19 mm) inlet spud with 2" (51 mm) outlet connection
- Wall hangers included
- Manual piston-operated flush valve
- Exclusive DynaClean® self-cleaning wiper spring technology
- Integral wiper spring cleans refill orifice with every flush to help prevent valve run-on
- Non-hold open handle provides automatic shut-off



Description	SKU	Color	List Price
Pintbrook® Urinal System With Manual Piston Flush Valve, 0.125 gpf/0.5 Lpf	6002503.020	White	377

Separate Components:

Pintbrook® 0.125 – 0.5 gpf (0.47 – 1.9 Lpf) Top Spud Urinal	6002001.020	White	
Ultima™ Manual Urinal Flush Valve, Piston-Type, 0.125 gpf/0.5 Lpf	6045013.002	Polished Chrome	

Commercial Fittings

Touchless Faucets and Soap Dispenser	Paradigm® NextGen Selectronic®	Serin® Sensor-Operated	Selectronic®	Metering	Commercial
					
					
Light Commercial	Commercial Shower System Kits	Service Sink Faucets	Commercial/Institutional/Hospital	Diaphragm Flush Valves	Piston Flush Valves
   		 		 	 

Faucets

Commercial Fittings

Touchless Integrated Faucet/Soap Dispenser, Battery Powered, 1.2 gpm/4.5 Lpm



- Includes 4 D-sized alkaline batteries
- Stylish spout dispenses foam soap and water for a hygienic hand wash
- Touchless operation limits the spread of germs
- Uses universal bulk foam soap; no proprietary soaps needed
- Air infused foam soap generator with 4 adjustable foam volume settings
- Includes 1,800 ml soap bottle with quick disconnect
- Vandal-resistant brass spout with single-hole installation
- Vandal-resistant 1.2 gpm/4.5 Lpm rectangular aerator
- Optional deck plate for 4" (102 mm) centers available



Description	SKU	Color	List Price
2-In-1 Integral Touchless Faucet / Soap Dispenser, Battery Powered	7762112.002	Polished Chrome	876
Optional Components:			
4-Inch Deck Plate	7353101P.002	Polished Chrome	46

Touchless Integrated Faucet/Soap Dispenser, Base Model, 1.2 gpm/4.5 Lpm



- Base model uses the existing American Standard Plug-In or Hard-Wired AC power kits (sold separately)
- Stylish spout dispenses foam soap and water for a hygienic hand wash
- Touchless operation limits the spread of germs
- Uses universal bulk foam soap; no proprietary soaps needed
- Air infused foam soap generator with 4 adjustable foam volume settings
- Includes 1,800 ml soap bottle with quick disconnect
- Vandal-resistant brass spout with single-hole installation
- Vandal-resistant 1.2 gpm/4.5 Lpm rectangular aerator
- Optional deck plate for 4" (102 mm) centers available



Description	SKU	Color	List Price
2-In-1 Integral Touchless Faucet/Soap Dispenser, Base Model	776B112.002	Polished Chrome	814
Required Components:			
Selectronic® Hard Wired AC Power Kit	PK00.HAC	No Finish	129
Selectronic® Plug-In AC Power Kit	PK00.PAC	No Finish	94
Optional Components:			
4-Inch Deck Plate	7353101P.002	Polished Chrome	46

Faucets

Selectronic® Power Kit details

Commercial Fittings

Touchless Sensor-Operated Foam Soap Dispenser



- Touchless operation limits the spread of germs
- Uses universal bulk foam soap instead of proprietary cartridges
- Soap Viscosity Range: 1 - 20 centipoise (cps)
- Portion Control: 4 options to set the amount of soap dispensed per activation. Maximum of 1,800 portions per 1.8L bottle
- Initialization Mode: Simplified start-up by pumping soap through system
- Includes 4 D-sized alkaline batteries
- Battery Life: 100,000 uses
- Low Battery Indicator: Blinks every 2 seconds
- Includes 1,800 ml soap bottle with quick disconnect
- Optional shank extension (8888004.002) available for thicker mounting surfaces



Description	SKU	Color	List Price
Touchless Sensor-Operated Foam Soap Dispenser, Battery Powered	7770100.002	Polished Chrome	546
	7770100.295	Brushed Nickel	636

Optional Components:

Shank Extension for Touchless Soap Dispenser	8888004.002	Polished Chrome	25
--	-------------	-----------------	----



- **SELECTRONIC AC POWER KIT MUST BE PURCHASED SEPARATELY**
- Choice of Plug-In (PK00.PAC) or Hard-Wired AC (PK00.HAC)
- Touchless operation limits the spread of germs
- Uses universal bulk foam soap instead of proprietary cartridges
- Soap Viscosity Range: 1 - 20 centipoise (cps)
- Portion Control: 4 options to set the amount of soap dispensed per activation. Maximum of 1,800 portions per 1.8L bottle
- Initialization Mode: Simplified start-up by pumping soap through system
- Includes 1,800 ml soap bottle with quick disconnect
- Optional shank extension (8888004.002) available for thicker mounting surfaces



Description	SKU	Color	List Price
Touchless Sensor-Operated Foam Soap Dispenser, Base Model	777B100.002	Polished Chrome	485
	777B100.295	Brushed Nickel	564

Required Components:

Selectronic® Hard Wired AC Power Kit	PK00.HAC	No Finish	129
Selectronic® Plug-In AC Power Kit	PK00.PAC	No Finish	94

Optional Components:

Shank Extension for Touchless Soap Dispenser	8888004.002	Polished Chrome	25
--	-------------	-----------------	----

Commercial Fittings

Clean IR® Touchless Selectronic® Faucet – Battery Powered With Above Deck Mixing



- Touchless operation limits the spread of germs for a safer restroom
- Flexible Selectronic® platform with programmable sensor
- CR-P2 lithium battery included
- Battery Life: 7 years at 150 uses per day
- Above-Deck Mixing: Allows user to manually adjust temperature. Adjustable hot limit stop. Red & blue indicators
- Clean, integrated design: All electronics contained in faucet spout. No control box below deck
- Dual inlets: For hot and cold water. Check valves included to prevent cross flow. Filter assemblies protect the solenoid valve from debris
- Easy installation & maintenance: Faucet installs from the top. All serviceable parts are easily accessible
- 0.5 gpm pressure compensating, vandal-resistant multi-laminar spray
- Optional remote control (605XRCW) allows for customization



Description	SKU	Color	List Price
Clean IR™ Touchless Faucet, Battery-Powered with Above-Deck Mixing, 0.5 gpm/1.9 Lpm	7020205.002	Polished Chrome	310
	7020205.295	Brushed Nickel	372
Optional Components:			
Clean IR™ 4-Inch Deck Plate	70204P0.002	Polished Chrome	25
	70204P0.295	Brushed Nickel	30
Clean IR™ 8-Inch Deck Plate	70208P0.002	Polished Chrome	32
	70208P0.295	Brushed Nickel	39

Commercial Fittings

Paradigm® Selectronic® Integrated Faucet – Battery Powered



- 5-year CR-P2 lithium battery installed in faucet
- Touchless operation limits the spread of germs
- Clean, integrated design. No control box below deck
- Less mixing
- Easy installation and maintenance: Faucet installs from the top. All serviceable parts are easily accessible
- Auto Purge: Periodically purges stagnant water
- Safety Timer: Automatically turns water off after 55 seconds
- Adjustable Range: Detection zone can be adjusted manually or with optional remote control
- Single inlet for cold or tempered water
- Optional deck plates and remote control available (sold separately)



Description	SKU	Color	List Price
Paradigm® Selectronic® Touchless Faucet, Battery-Powered, 0.35 gpm/1.3 Lpm	7025103.002	Polished Chrome	510
	7025103.295	Brushed Nickel	638
Paradigm® Selectronic® Touchless Faucet, Battery-Powered, 0.5 gpm/1.9 Lpm	7025105.002	Polished Chrome	489
	7025105.295	Brushed Nickel	638
Optional Components:			
Paradigm® 4-Inch Deck Plate	702P400.002	Polished Chrome	64
	702P400.295	Brushed Nickel	75
NextGen™ 8-Inch Deck Plate	775P800.002	Polished Chrome	86
	775P800.295	Brushed Nickel	102

Paradigm® Selectronic® Integrated Faucet With Above-Deck Mixing – Battery Powered



- 5-year CR-P2 lithium battery installed in faucet
- Touchless operation limits the spread of germs
- Above-deck mixing with removable handle
- Clean, integrated design. No control box below deck
- Easy installation and maintenance: Faucet installs from the top. All serviceable parts are easily accessible
- Auto Purge: Periodically purges stagnant water
- Safety Timer: Automatically turns water off after 55 seconds
- Adjustable Range: Detection zone can be adjusted manually or with optional remote control
- Dual inlets for hot and cold water
- Optional deck plates and remote control available (sold separately)



Description	SKU	Color	List Price
Paradigm® Selectronic® Touchless Faucet, Battery-Powered With Above-Deck Mixing, 0.35 gpm/1.3 Lpm	7025203.002	Polished Chrome	518
	7025203.295	Brushed Nickel	677
Paradigm® Selectronic® Touchless Faucet, Battery-Powered With Above-Deck Mixing, 0.5 gpm/1.9 Lpm	7025205.002	Polished Chrome	518
	7025205.295	Brushed Nickel	677
Optional Components:			
Paradigm® 4-Inch Deck Plate	702P400.002	Polished Chrome	64
	702P400.295	Brushed Nickel	75
NextGen™ 8-Inch Deck Plate	775P800.002	Polished Chrome	86
	775P800.295	Brushed Nickel	102

Commercial Fittings

Paradigm® Selectronic® Integrated Faucet With SmarTherm® – Battery Powered



- 5-year CR-P2 lithium battery installed in faucet
- Touchless operation limits the spread of germs
- SmarTherm® safety shut-off prevents accidental scalding. ASSE 1070 certified
- Above-deck mixing with removable handle
- Clean, integrated design. No control box below deck
- Easy installation and maintenance: Faucet installs from the top. All serviceable parts are easily accessible
- Auto Purge: Periodically purges stagnant water
- Safety Timer: Automatically turns water off after 55 seconds
- Dual inlets for hot and cold water
- Optional deck plates and remote control available (sold separately)

SmarTherm®

ASSE 1070 certifie



Description	SKU	Color	List Price
Paradigm® Selectronic® Touchless Faucet, Battery-Powered With SmarTherm Safety Shut-Off + ADM, 0.35 gpm/1.3 Lpm	7025303.002	Polished Chrome	627
	7025303.295	Brushed Nickel	817
Paradigm® Selectronic® Touchless Faucet, Battery-Powered With SmarTherm Safety Shut-Off + ADM, 0.5 gpm/1.9 Lpm	7025305.002	Polished Chrome	627
	7025305.295	Brushed Nickel	817
Optional Components:			
Paradigm® 4-Inch Deck Plate	702P400.002	Polished Chrome	64
	702P400.295	Brushed Nickel	75
NextGen™ 8-Inch Deck Plate	775P800.002	Polished Chrome	86
	775P800.295	Brushed Nickel	102

Paradigm® Selectronic® Integrated Faucet – Base Model PWRX® and AC Powered



- POWER KIT MUST BE PURCHASED SEPARATELY
- Touchless operation limits the spread of germs
- Clean, integrated design. No control box below deck
- Less mixing
- Easy installation and maintenance: Faucet installs from the top. All serviceable parts are easily accessible
- Auto Purge: Periodically purges stagnant water
- Safety Timer: Automatically turns water off after 55 seconds
- Adjustable Range: Detection zone can be adjusted manually or with optional remote control
- Single inlet for cold or tempered water
- Optional deck plates and remote control available (sold separately)



Description	SKU	Color	List Price
Paradigm® Selectronic® Touchless Faucet, Base Model, 0.35 gpm/1.3 Lpm	702B103.002	Polished Chrome	436
	702B103.295	Brushed Nickel	545
Paradigm® Selectronic® Touchless Faucet, Base Model, 0.5 gpm/1.9 Lpm	702B105.002	Polished Chrome	436
	702B105.295	Brushed Nickel	545
Required Components:			
Selectronic® Hard Wired AC Power Kit	PK00.HAC	No Finish	129
Selectronic® Multi-AC Power Kit	PK00.MAC	No Finish	72
Selectronic® Plug-In AC Power Kit	PK00.PAC	No Finish	94
Selectronic® PWRX® Power Kit	PK00.WRK	No Finish	158
Optional Components:			
Paradigm® 4-Inch Deck Plate	702P400.002	Polished Chrome	64
	702P400.295	Brushed Nickel	75
NextGen™ 8-Inch Deck Plate	775P800.002	Polished Chrome	86
	775P800.295	Brushed Nickel	102
Selectronic® Battery Back-Up Kit	PK00.BBU	No Finish	88

Selectronic® Power Kit details

Commercial Fittings

Paradigm® Selectronic® Integrated Faucet With Above-Deck Mixing – Base Model PWRX® and AC Powered



- POWER KIT MUST BE PURCHASED SEPARATELY
- Touchless operation limits the spread of germs
- Above-deck mixing with removable handle
- Clean, integrated design. No control box below deck
- Easy installation and maintenance: Faucet installs from the top. All serviceable parts are easily accessible
- Auto Purge: Periodically purges stagnant water
- Safety Timer: Automatically turns water off after 55 seconds
- Adjustable Range: Detection zone can be adjusted manually or with optional remote control
- Dual inlets for hot and cold water
- Optional deck plates and remote control available (sold separately)



Description	SKU	Color	List Price
Paradigm® Selectronic® Touchless Faucet, Base Model With Above-Deck Mixing, 0.35 gpm/1.3 Lpm	702B203.002	Polished Chrome	468
	702B203.295	Brushed Nickel	583
Paradigm® Selectronic® Touchless Faucet, Base Model With Above-Deck Mixing, 0.5 gpm/1.9 Lpm	702B205.002	Polished Chrome	468
	702B205.295	Brushed Nickel	583
Required Components:			
Selectronic® Hard Wired AC Power Kit	PK00.HAC	No Finish	129
Selectronic® Multi-AC Power Kit	PK00.MAC	No Finish	72
Selectronic® Plug-In AC Power Kit	PK00.PAC	No Finish	94
Selectronic® PWRX® Power Kit	PK00.WRK	No Finish	158
Optional Components:			
Paradigm® 4-Inch Deck Plate	702P400.002	Polished Chrome	64
	702P400.295	Brushed Nickel	75
NextGen™ 8-Inch Deck Plate	775P800.002	Polished Chrome	86
	775P800.295	Brushed Nickel	102
Selectronic® Battery Back-Up Kit	PK00.BBU	No Finish	88

Commercial Fittings

Paradigm® Selectronic® Integrated Faucet With SmarTherm® – Base Model PWRX® and AC Powered



- POWER KIT MUST BE PURCHASED SEPARATELY
- Touchless operation limits the spread of germs
- SmarTherm® safety shut-off prevents accidental scalding. ASSE 1070 certified
- Above-deck mixing with removable handle
- Clean, integrated design. No control box below deck
- Easy installation and maintenance: Faucet installs from the top. All serviceable parts are easily accessible
- Auto Purge: Periodically purges stagnant water
- Safety Timer: Automatically turns water off after 55 seconds
- Dual inlets for hot and cold water
- Optional deck plates and remote control available (sold separately)

SmarTherm®
SmarTherm®

ASSE 1070 certifie



Description	SKU	Color	List Price
Paradigm® Selectronic® Touchless Faucet, Base Model With SmarTherm Safety Shut-Off + ADM, 0.35 gpm/1.3 Lpm	702B303.002	Polished Chrome	579
	702B303.295	Brushed Nickel	723
Paradigm® Selectronic® Touchless Faucet, Base Model With SmarTherm Safety Shut-Off + ADM, 0.5 gpm/1.9 Lpm	702B305.002	Polished Chrome	579
	702B305.295	Brushed Nickel	723
Required Components:			
Selectronic® Hard Wired AC Power Kit	PK00.HAC	No Finish	129
Selectronic® Multi-AC Power Kit	PK00.MAC	No Finish	72
Selectronic® Plug-In AC Power Kit	PK00.PAC	No Finish	94
Selectronic® PWRX® Power Kit	PK00.WRK	No Finish	158
Optional Components:			
Paradigm® 4-Inch Deck Plate	702P400.002	Polished Chrome	64
	702P400.295	Brushed Nickel	75
NextGen™ 8-Inch Deck Plate	775P800.002	Polished Chrome	86
	775P800.295	Brushed Nickel	102
Selectronic® Battery Back-Up Kit	PK00.BBU	No Finish	88

Commercial Fittings

NextGen Selectronic® Integrated Faucet – Battery Powered



- 5-year CR-P2 lithium battery installed in faucet
- Touchless operation limits the spread of germs
- Clean, integrated design. No control box below deck
- Less mixing
- Easy installation and maintenance: Faucet installs from the top. All serviceable parts are easily accessible
- Auto Purge: Periodically purges stagnant water
- Safety Timer: Automatically turns water off after 55 seconds
- Adjustable Range: Detection zone can be adjusted manually or with optional remote control
- Single inlet for cold or tempered water
- Optional deck plates and remote control available (sold separately)



	Description	SKU	Color	List Price
CEC	NextGen Selectronic® Touchless Faucet, Battery-Powered, 0.35 gpm/1.3 Lpm	7755103.002	Polished Chrome	465
		7755103.295	Brushed Nickel	606
CEC	NextGen Selectronic® Touchless Faucet, Battery-Powered, 0.5 gpm/1.9 Lpm	7755105.002	Polished Chrome	465
		7755105.295	Brushed Nickel	606
	NextGen Selectronic® Touchless Faucet, Battery-Powered, 1.5 gpm/5.7 Lpm	7755115.002	Polished Chrome	465
		Optional Components:		
	NextGen 4-Inch Deck Plate	775P400.002	Polished Chrome	58
		775P400.295	Brushed Nickel	70
	NextGen 8-Inch Deck Plate	775P800.002	Polished Chrome	86
		775P800.295	Brushed Nickel	102

NextGen Selectronic® Integrated Faucet With Above-Deck Mixing – Battery Powered



- 5-year CR-P2 lithium battery installed in faucet
- Touchless operation limits the spread of germs
- Above-deck mixing with removable handle
- Clean, integrated design. No control box below deck
- Easy installation and maintenance: Faucet installs from the top. All serviceable parts are easily accessible
- Auto Purge: Periodically purges stagnant water
- Safety Timer: Automatically turns water off after 55 seconds
- Adjustable Range: Detection zone can be adjusted manually or with optional remote control
- Dual inlets for hot and cold water
- Optional deck plates and remote control available (sold separately)



	Description	SKU	Color	List Price
CEC	NextGen Selectronic® Touchless Faucet, Battery-Powered With Above-Deck Mixing, 0.35 gpm/1.3 Lpm	7755203.002	Polished Chrome	496
		7755203.295	Brushed Nickel	646
CEC	NextGen Selectronic® Touchless Faucet, Battery-Powered With Above-Deck Mixing, 0.5 gpm/1.9 Lpm	7755205.002	Polished Chrome	496
		7755205.295	Brushed Nickel	646
	NextGen Selectronic® Touchless Faucet, Battery-Powered With Above-Deck Mixing, 1.5 gpm/5.7 Lpm	7755215.002	Polished Chrome	496
		Optional Components:		
	NextGen 4-Inch Deck Plate	775P400.002	Polished Chrome	58
		775P400.295	Brushed Nickel	70
	NextGen 8-Inch Deck Plate	775P800.002	Polished Chrome	86
		775P800.295	Brushed Nickel	102

Commercial Fittings

NextGen Selectronic® Integrated Faucet With SmarTherm® – Battery Powered



- 5-year CR-P2 lithium battery installed in faucet
- Touchless operation limits the spread of germs
- SmarTherm® safety shut-off prevents accidental scalding. ASSE 1070 certified
- Above-deck mixing with removable handle
- Clean, integrated design. No control box below deck
- Easy installation and maintenance: Faucet installs from the top. All serviceable parts are easily accessible
- Auto Purge: Periodically purges stagnant water
- Safety Timer: Automatically turns water off after 55 seconds
- Dual inlets for hot and cold water
- Optional deck plates and remote control available (sold separately)

SmarTherm®

ASSE 1070 certifie



	Description	SKU	Color	List Price
	NextGen Selectronic® Touchless Faucet, Battery-Powered With SmarTherm Safety Shut-Off + ADM, 0.35 gpm/1.3 Lpm	7755303.002	Polished Chrome	613
		7755303.295	Brushed Nickel	799
	NextGen Selectronic® Touchless Faucet, Battery-Powered With SmarTherm Safety Shut-Off + ADM, 0.5 gpm/1.9 Lpm	7755305.002	Polished Chrome	613
		7755305.295	Brushed Nickel	799
	NextGen Selectronic® Touchless Faucet, Battery-Powered With SmarTherm Safety Shut-Off + ADM, 1.5 gpm/5.7 Lpm	7755315.002	Polished Chrome	613
Optional Components:				
	NextGen 4-Inch Deck Plate	775P400.002	Polished Chrome	58
		775P400.295	Brushed Nickel	70
	NextGen 8-Inch Deck Plate	775P800.002	Polished Chrome	86
		775P800.295	Brushed Nickel	102

NextGen Selectronic® Integrated Faucet – Base Model PWRX® and AC Powered



- POWER KIT MUST BE PURCHASED SEPARATELY
- Touchless operation limits the spread of germs
- Clean, integrated design. No control box below deck
- Less mixing
- Easy installation and maintenance: Faucet installs from the top. All serviceable parts are easily accessible
- Auto Purge: Periodically purges stagnant water
- Safety Timer: Automatically turns water off after 55 seconds
- Adjustable Range: Detection zone can be adjusted manually or with optional remote control
- Single inlet for cold or tempered water
- Optional deck plates and remote control available (sold separately)



	Description	SKU	Color	List Price
	NextGen Selectronic® Touchless Faucet, Base Model, 0.35 gpm/1.3 Lpm	775B103.002	Polished Chrome	415
		775B103.295	Brushed Nickel	518
	NextGen Selectronic® Touchless Faucet, Base Model, 0.5 gpm/1.9 Lpm	775B105.002	Polished Chrome	415
		775B105.295	Brushed Nickel	518
Required Components:				
	Selectronic® Hard Wired AC Power Kit	PK00.HAC	No Finish	129
	Selectronic® Multi-AC Power Kit	PK00.MAC	No Finish	72
	Selectronic® Plug-In AC Power Kit	PK00.PAC	No Finish	94
	Selectronic® PWRX® Power Kit	PK00.WRK	No Finish	158
Optional Components:				
	NextGen 4-Inch Deck Plate	775P400.002	Polished Chrome	58
	NextGen 8-Inch Deck Plate	775P800.002	Polished Chrome	86
	Selectronic® Battery Back-Up Kit	PK00.BBU	No Finish	88

Commercial Fittings

NextGen Selectronic® Integrated Faucet With Above-Deck Mixing – Base Model PWRX® and AC Powered



- POWER KIT MUST BE PURCHASED SEPARATELY
- Touchless operation limits the spread of germs
- Above-deck mixing with removable handle
- Clean, integrated design. No control box below deck
- Easy installation and maintenance: Faucet installs from the top. All serviceable parts are easily accessible
- Auto Purge: Periodically purges stagnant water
- Safety Timer: Automatically turns water off after 55 seconds
- Adjustable Range: Detection zone can be adjusted manually or with optional remote control
- Dual inlets for hot and cold water
- Optional deck plates and remote control available (sold separately)



Description	SKU	Color	List Price
NextGen Selectronic® Touchless Faucet, Base Model With Above-Deck Mixing, 0.35 gpm/1.3 Lpm	775B203.002	Polished Chrome	447
	775B203.295	Brushed Nickel	559
NextGen Selectronic® Touchless Faucet, Base Model With Above-Deck Mixing, 0.5 gpm/1.9 Lpm	775B205.002	Polished Chrome	447
	775B205.295	Brushed Nickel	559
Required Components:			
Selectronic® Hard Wired AC Power Kit	PK00.HAC	No Finish	129
Selectronic® Multi-AC Power Kit	PK00.MAC	No Finish	72
Selectronic® Plug-In AC Power Kit	PK00.PAC	No Finish	94
Selectronic® PWRX® Power Kit	PK00.WRK	No Finish	158
Optional Components:			
NextGen 4-Inch Deck Plate	775P400.002	Polished Chrome	58
NextGen 8-Inch Deck Plate	775P800.002	Polished Chrome	86
Selectronic® Battery Back-Up Kit	PK00.BBU	No Finish	88

Commercial Fittings

NextGen Selectronic® Integrated Faucet With SmarTherm® – Base Model PWRX® and AC Powered



- POWER KIT MUST BE PURCHASED SEPARATELY
- Touchless operation limits the spread of germs
- SmarTherm® safety shut-off prevents accidental scalding. ASSE 1070 certified
- Above-deck mixing with removable handle
- Clean, integrated design. No control box below deck
- Easy installation and maintenance: Faucet installs from the top. All serviceable parts are easily accessible
- Auto Purge: Periodically purges stagnant water
- Safety Timer: Automatically turns water off after 55 seconds
- Dual inlets for hot and cold water
- Optional deck plates and remote control available (sold separately)

SmarTherm®
ASSE 1070 certifie



Description	SKU	Color	List Price
NextGen Selectronic® Touchless Faucet, Base Model With SmarTherm Safety Shut-Off + ADM, 0.35 gpm/1.3 Lpm	775B303.002	Polished Chrome	567
	775B303.295	Brushed Nickel	709
NextGen Selectronic® Touchless Faucet, Base Model With SmarTherm Safety Shut-Off + ADM, 0.5 gpm/1.9 Lpm	775B305.002	Polished Chrome	567
	775B305.295	Brushed Nickel	709

Required Components:

Selectronic® Hard Wired AC Power Kit	PK00.HAC	No Finish	129
Selectronic® Multi-AC Power Kit	PK00.MAC	No Finish	72
Selectronic® Plug-In AC Power Kit	PK00.PAC	No Finish	94
Selectronic® PWRX® Power Kit	PK00.WRK	No Finish	158

Optional Components:

NextGen 4-Inch Deck Plate	775P400.002	Polished Chrome	58
NextGen 8-Inch Deck Plate	775P800.002	Polished Chrome	86
Selectronic® Battery Back-Up Kit	PK00.BBU	No Finish	88

Commercial Fittings

Serin® Deck-Mount Touchless Faucets – Battery Powered



- Includes 4-year CR-P2 lithium battery
- Touchless operation limits the spread of germs
- Sensor in spout tip for streamlined style and reduced vandalism
- Self-adjusting sensor automatically sets range for optimum performance
- Single inlet for cold or tempered water
- Vandal-resistant brass spout with single-hole installation
- Safety Timer: Automatically turns water off after 55 seconds
- Single inlet for cold or tempered water
- Optional deck plates, mixing valve and remote control available (sold separately)



Description	SKU	Color	List Price
Serin® Touchless Faucet, Battery-Powered, 0.35 gpm/1.3 Lpm	2064156.002	Polished Chrome	752
	2064156.295	Brushed Nickel	982
Serin® Touchless Faucet, Battery-Powered, 0.5 gpm/1.9 Lpm	2064155.002	Polished Chrome	752
	2064155.295	Brushed Nickel	982
Optional Components:			
Serin® 4-Inch Deck Plate	206P400.002	Polished Chrome	79
	206P400.295	Brushed Nickel	103
Serin® 8-Inch Deck Plate	206P800.002	Polished Chrome	97
	206P800.295	Brushed Nickel	121

Serin® Deck-Mount Touchless Faucets – Base Model PWRX® and AC Powered



- POWER KIT MUST BE PURCHASED SEPARATELY
- Touchless operation limits the spread of germs
- Sensor in spout tip for streamlined style and reduced vandalism
- Self-adjusting sensor automatically sets range for optimum performance
- Single inlet for cold or tempered water
- Vandal-resistant brass spout with single-hole installation
- Safety Timer: Automatically turns water off after 55 seconds
- Single inlet for cold or tempered water
- Optional deck plates, mixing valve and remote control available (sold separately)



Description	SKU	Color	List Price
Serin® Touchless Faucet, Base Model, 0.35 gpm/1.3 Lpm	206B106.002	Polished Chrome	711
	206B106.295	Brushed Nickel	941
Serin® Touchless Faucet, Base Model, 0.5 gpm/1.9 Lpm	206B105.002	Polished Chrome	711
	206B105.295	Brushed Nickel	941
Required Components:			
Selectronic® CR-P2 Lithium Power Kit	PK00.CRP	No Finish	42
Selectronic® Hard Wired AC Power Kit	PK00.HAC	No Finish	129
Selectronic® Multi-AC Power Kit	PK00.MAC	No Finish	72
Selectronic® Plug-In AC Power Kit	PK00.PAC	No Finish	94
Selectronic® PWRX® Power Kit	PK00.WRK	No Finish	158
Optional Components:			
Serin® 4-Inch Deck Plate	206P400.002	Polished Chrome	79
	206P400.295	Brushed Nickel	103
Serin® 8-Inch Deck Plate	206P800.002	Polished Chrome	97
	206P800.295	Brushed Nickel	121
Selectronic® Battery Back-Up Kit	PK00.BBU	No Finish	88

Selectronic® Power Kit details

Commercial Fittings

Serin® Wall-Mount Touchless Faucets – Battery Powered



- Includes 4-Year CR-P2 lithium battery
- R350 rough valve must be purchased separately
- Self-adjusting sensor automatically sets range for optimum performance
- Adjustable Spout Reach: Easily adjustable from 6-inch (152 mm) – 9-inch (229 mm)
- Vandal-resistant brass spout
- Single inlet for cold or tempered water
- Touchless operation limits the spread of germs
- Safety Timer: Automatically turns water off after 55 seconds



Description	SKU	Color	List Price
Serin® Touchless Wall-Mount Trim, Battery-Powered, 0.35 gpm/1.3 Lpm	T064356.002	Polished Chrome	660
	T064356.295	Brushed Nickel	861
Serin® Touchless Wall-Mount Trim, Battery-Powered, 0.5 gpm/1.9 Lpm	T064355.002	Polished Chrome	660
	T064355.295	Brushed Nickel	861

Required Components:

Rough Valve for Serin Wall-Mount Faucet	R350	No Finish	130
---	------	-----------	-----

Serin® Wall-Mount Touchless Faucets – Base Model PWRX® and AC Powered



- POWER KIT MUST BE PURCHASED SEPARATELY
- R350 rough valve must be purchased separately
- Touchless operation limits the spread of germs
- Sensor in spout tip for streamlined style and reduced vandalism
- Self-adjusting sensor automatically sets range for optimum performance
- Adjustable Spout Reach: Easily adjustable from 6" (152 mm) – 9" (229 mm)
- Vandal-resistant brass spout
- Safety Timer: Automatically turns water off after 55 seconds
- Single inlet for cold or tempered water



Description	SKU	Color	List Price
Serin® Touchless Wall-Mount Trim, Base Model, 0.35 gpm/1.3 Lpm	T06B306.002	Polished Chrome	616
	T06B306.295	Brushed Nickel	819
Serin® Touchless Wall-Mount Trim, Base Model, 0.5 gpm/1.9 Lpm	T06B305.002	Polished Chrome	616
	T06B305.295	Brushed Nickel	819

Required Components:

Selectronic® CR-P2 Lithium Power Kit	PK00.CRP	No Finish	42
Selectronic® Hard Wired AC Power Kit	PK00.HAC	No Finish	129
Selectronic® Multi-AC Power Kit	PK00.MAC	No Finish	72
Selectronic® Plug-In AC Power Kit	PK00.PAC	No Finish	94
Selectronic® PWRX® Power Kit	PK00.WRK	No Finish	158
Rough Valve for Serin Wall-Mount Faucet	R350	No Finish	130

Optional Components:

Selectronic® Battery Back-Up Kit	PK00.BBU	No Finish	88
----------------------------------	----------	-----------	----

Commercial Fittings

Selectronic® Touchless Faucets – Cast Spout – Battery Powered



- Includes 4-year CR-P2 lithium battery
- Touchless operation limits the spread of germs for a safer restroom
- Single inlet for cold or tempered water
- Vandal-resistant cast spout with single-hole installation
- Adjustable Range: Detection zone can be adjusted manually or with optional remote control
- Safety Timer: Automatically turns water off after 30 seconds
- Auto Purge: Faucet can be programmed to periodically purge stagnant water
- Fail-Safe Technology: Faucet automatically shuts off upon loss of power or dead battery
- Optional deck plates, thermostatic mixing valve and remote control available (sold separately)



Description	SKU	Color	List Price
Selectronic® Cast Touchless Faucet, Battery-Powered, 0.5 gpm/1.9 Lpm	6055105.002	Polished Chrome	559
Selectronic® Cast Touchless Metering Faucet, Battery-Powered, 0.35 gpm/1.3 Lpm	6055104.002	Polished Chrome	559
Optional Components:			
Selectronic® 4-Inch Deck Plate	605P400.002	Polished Chrome	47
Selectronic® 8-Inch Deck Plate	605P800.002	Polished Chrome	77

Selectronic® Touchless Faucets – Cast Spout – Base Model PWRX® and AC Powered



- POWER KIT MUST BE PURCHASED SEPARATELY
- Touchless operation limits the spread of germs for a safer restroom
- Single inlet for cold or tempered water
- Vandal-resistant cast spout with single-hole installation
- Adjustable Range: Detection zone can be adjusted manually or with optional remote control
- Safety Timer: Automatically turns water off after 30 seconds
- Auto Purge: Faucet can be programmed to periodically purge stagnant water
- Fail-Safe Technology: Faucet automatically shuts off upon loss of power or dead battery
- Optional deck plates, thermostatic mixing valve and remote control available (sold separately)



Description	SKU	Color	List Price
Selectronic® Cast Touchless Faucet, Base Model, 0.5 gpm/1.9 Lpm	605B105.002	Polished Chrome	523
Selectronic® Cast Touchless Metering Faucet, Base Model, 0.35 gpm/1.3 Lpm	605B104.002	Polished Chrome	523
Required Components:			
Selectronic® CR-P2 Lithium Power Kit	PK00.CRP	No Finish	42
Selectronic® Hard Wired AC Power Kit	PK00.HAC	No Finish	129
Selectronic® Multi-AC Power Kit	PK00.MAC	No Finish	72
Selectronic® Plug-In AC Power Kit	PK00.PAC	No Finish	94
Selectronic® PWRX® Power Kit	PK00.WRK	No Finish	158
Optional Components:			
Selectronic® 4-Inch Deck Plate	605P400.002	Polished Chrome	47
Selectronic® 8-Inch Deck Plate	605P800.002	Polished Chrome	77
Selectronic® Battery Back-Up Kit	PK00.BBU	No Finish	88

Faucets

Selectronic® Power Kit details

Commercial Fittings

Selectronic® Touchless Faucets – Gooseneck Spout – Battery Powered



- Includes 4-Year CR-P2 lithium battery
- Touchless operation limits the spread of germs for a safer restroom
- Single inlet for cold or tempered water
- Vandal-resistant brass spout with single-hole installation
- Adjustable Range: Detection zone can be adjusted manually or with optional remote control
- Safety Timer: Automatically turns water off after 30 seconds
- Auto Purge: Faucet can be programmed to periodically purge stagnant water
- Fail-Safe Technology: Faucet automatically shuts off upon loss of power or dead battery
- Optional deck plates, thermostatic mixing valve and remote control available (sold separately)



Description	SKU	Color	List Price
Selectronic® Gooseneck Touchless Faucet, Battery-Powered, 0.5 gpm/1.9 Lpm	6055165.002	Polished Chrome	625
Selectronic® Gooseneck Touchless Metering Faucet, Battery-Powered, 0.35 gpm/1.3 Lpm	6055164.002	Polished Chrome	625
Optional Components:			
Selectronic® 4-Inch Deck Plate	605P400.002	Polished Chrome	47
Selectronic® 8-Inch Deck Plate	605P800.002	Polished Chrome	77

Selectronic® Touchless Faucets – Gooseneck Spout – Base Model PWRX® and AC Powered



- POWER KIT MUST BE PURCHASED SEPARATELY
- Touchless operation limits the spread of germs for a safer restroom
- Single inlet for cold or tempered water
- Vandal-resistant brass spout with single-hole installation
- Adjustable Range: Detection zone can be adjusted manually or with optional remote control
- Safety Timer: Automatically turns water off after 30 seconds
- Auto Purge: Faucet can be programmed to periodically purge stagnant water
- Fail-Safe Technology: Faucet automatically shuts off upon loss of power or dead battery
- Optional deck plates, thermostatic mixing valve and remote control available (sold separately)



Description	SKU	Color	List Price
Selectronic® Gooseneck Touchless Faucet, Base Model, 0.5 gpm/1.9 Lpm	605B165.002	Polished Chrome	587
Selectronic® Gooseneck Touchless Metering Faucet, Base Model, 0.35 gpm/1.3 Lpm	605B164.002	Polished Chrome	587
Required Components:			
Selectronic® CR-P2 Lithium Power Kit	PK00.CRP	No Finish	42
Selectronic® Hard Wired AC Power Kit	PK00.HAC	No Finish	129
Selectronic® Multi-AC Power Kit	PK00.MAC	No Finish	72
Selectronic® Plug-In AC Power Kit	PK00.PAC	No Finish	94
Selectronic® PWRX® Power Kit	PK00.WRK	No Finish	158
Optional Components:			
Selectronic® 4-Inch Deck Plate	605P400.002	Polished Chrome	47
Selectronic® 8-Inch Deck Plate	605P800.002	Polished Chrome	77
Selectronic® Battery Back-Up Kit	PK00.BBU	No Finish	88

Selectronic® Power Kit details

Commercial Fittings

Selectronic® IC Touchless Faucets – Battery Powered



- Ideal for Healthcare - Laminar flow restrictor in base and plain spout end
- Includes 4-Year CR-P2 lithium battery
- Touchless operation limits the spread of germs for a safer restroom
- Single inlet for cold or tempered water
- Vandal-resistant brass spout with single-hole installation
- Adjustable Range: Detection zone can be adjusted manually or with optional remote control
- Safety Timer: Automatically turns water off after 30 seconds
- Auto Purge: Faucet can be programmed to periodically purge stagnant water
- Fail-Safe Technology: Faucet automatically shuts off upon loss of power or dead battery
- Optional deck plates, thermostatic mixing valve and remote control available (sold separately)



Description	SKU	Color	List Price
Selectronic® IC Touchless Faucet, Battery-Powered, 1.5 gpm/5.7 Lpm Laminar Flow in Base	605P193.002	Polished Chrome	635
Optional Components:			
Selectronic® 4-Inch Deck Plate	605P400.002	Polished Chrome	47
Selectronic® 8-Inch Deck Plate	605P800.002	Polished Chrome	77

Selectronic® IC Touchless Faucets – Base Model PWRX® and AC Powered



- Ideal for Healthcare - Laminar flow restrictor in base and plain spout end
- POWER KIT MUST BE PURCHASED SEPARATELY
- Touchless operation limits the spread of germs for a safer restroom
- Single inlet for cold or tempered water
- Vandal-resistant brass spout with single-hole installation
- Adjustable Range: Detection zone can be adjusted manually or with optional remote control
- Safety Timer: Automatically turns water off after 30 seconds
- Auto Purge: Faucet can be programmed to periodically purge stagnant water
- Fail-Safe Technology: Faucet automatically shuts off upon loss of power or dead battery
- Optional deck plates, thermostatic mixing valve and remote control available (sold separately)



Description	SKU	Color	List Price
Selectronic® IC Touchless Faucet, Base Model, 1.5 gpm/5.7 Lpm Laminar Flow in Base	605B193.002	Polished Chrome	596
Required Components:			
Selectronic® CR-P2 Lithium Power Kit	PK00.CRP	No Finish	42
Selectronic® Hard Wired AC Power Kit	PK00.HAC	No Finish	129
Selectronic® Multi-AC Power Kit	PK00.MAC	No Finish	72
Selectronic® Plug-In AC Power Kit	PK00.PAC	No Finish	94
Selectronic® PWRX® Power Kit	PK00.WRK	No Finish	158
Optional Components:			
Selectronic® 4-Inch Deck Plate	605P400.002	Polished Chrome	47
Selectronic® 8-Inch Deck Plate	605P800.002	Polished Chrome	77

Faucets

Selectronic® Power Kit details

Commercial Fittings

Innsbrook® Selectronic® Touchless Faucets – Battery Powered



- Includes 4-year CR-P2 lithium battery
- Touchless operation limits the spread of germs for a safer restroom
- Single inlet for cold or tempered water
- Vandal-resistant cast 4-inch centerset spout
- Adjustable Range: Detection zone can be adjusted manually or with optional remote control
- Safety Timer: Automatically turns water off after 30 seconds
- Auto Purge: Faucet can be programmed to periodically purge stagnant water
- Fail-Safe Technology: Faucet automatically shuts off upon loss of power or dead battery
- Optional deck plates, thermostatic mixing valve and remote control available (sold separately)



Description	SKU	Color	List Price
Innsbrook® Selectronic® Touchless Faucet, Battery-Powered, 0.5 gpm/1.9 Lpm	6055205.002	Polished Chrome	553
Innsbrook® Selectronic® Touchless Metering Faucet, Battery-Powered, 0.35 gpm/1.3 Lpm	6055204.002	Polished Chrome	553

Innsbrook® Selectronic® Touchless Faucets – Base Model PWRX® and AC Powered



- POWER KIT MUST BE PURCHASED SEPARATELY
- Touchless operation limits the spread of germs for a safer restroom
- Single inlet for cold or tempered water
- Vandal-resistant cast 4-inch centerset spout
- Adjustable Range: Detection zone can be adjusted manually or with optional remote control
- Safety Timer: Automatically turns water off after 30 seconds
- Auto Purge: Faucet can be programmed to periodically purge stagnant water
- Fail-Safe Technology: Faucet automatically shuts off upon loss of power or dead battery
- Optional deck plates, thermostatic mixing valve and remote control available (sold separately)



Description	SKU	Color	List Price
Innsbrook® Selectronic® Touchless Faucet, Base Model, 0.5 gpm/1.9 Lpm	605B205.002	Polished Chrome	516
Innsbrook® Selectronic® Touchless Metering Faucet, Base Model, 0.35 gpm/1.3 Lpm	605B204.002	Polished Chrome	516

Required Components:

Selectronic® CR-P2 Lithium Power Kit	PK00.CRP	No Finish	42
Selectronic® Hard Wired AC Power Kit	PK00.HAC	No Finish	129
Selectronic® Multi-AC Power Kit	PK00.MAC	No Finish	72
Selectronic® Plug-In AC Power Kit	PK00.PAC	No Finish	94
Selectronic® PWRX® Power Kit	PK00.WRK	No Finish	158

Optional Components:

Selectronic® Battery Back-Up Kit	PK00.BBU	No Finish	88
----------------------------------	----------	-----------	----

Selectronic® Power Kit details

Commercial Fittings

Moments® Selectronic® Touchless Faucets – Battery Powered



- Includes 4-Year CR-P2 lithium battery
- Touchless operation limits the spread of germs
- Single inlet for cold or tempered water
- Vandal-resistant brass spout with single-hole installation
- Adjustable Range: Detection zone can be adjusted manually or with optional remote control
- Safety Timer: Automatically turns water off after 30 seconds
- Auto Purge: Faucet can be programmed to periodically purge stagnant water
- Fail-Safe Technology: Faucet automatically shuts off upon loss of power or dead battery
- Optional deck plates, thermostatic mixing valve and remote control available (sold separately)



Description	SKU	Color	List Price
Moments® Selectronic® Touchless Faucet, Battery-Powered, 0.5 gpm/1.9 Lpm	2506155.002	Polished Chrome	715
	2506155.295	Brushed Nickel	895
Optional Components:			
Selectronic® 4-Inch Deck Plate	605P400.002	Polished Chrome	47
	605P400.295	Brushed Nickel	56
Selectronic® 8-Inch Deck Plate	605P800.002	Polished Chrome	77
	605P800.295	Brushed Nickel	92

Moments® Selectronic® Touchless Faucets – Base Model PWRX® and AC Powered



- POWER KIT MUST BE PURCHASED SEPARATELY
- Touchless operation limits the spread of germs
- Single inlet for cold or tempered water
- Vandal-resistant brass spout with single-hole installation
- Adjustable Range: Detection zone can be adjusted manually or with optional remote control
- Safety Timer: Automatically turns water off after 30 seconds
- Auto Purge: Faucet can be programmed to periodically purge stagnant water
- Fail-Safe Technology: Faucet automatically shuts off upon loss of power or dead battery
- Optional deck plates, thermostatic mixing valve and remote control available (sold separately)











Description	SKU	Color	List Price
Moments® Selectronic® Touchless Faucet, Base Model, 0.5 gpm/1.9 Lpm	250B105.002	Polished Chrome	677
Required Components:			
Selectronic® CR-P2 Lithium Power Kit	PK00.CRP	No Finish	42
Selectronic® Hard Wired AC Power Kit	PK00.HAC	No Finish	129
Selectronic® Multi-AC Power Kit	PK00.MAC	No Finish	72
Selectronic® Plug-In AC Power Kit	PK00.PAC	No Finish	94
Selectronic® PWRX® Power Kit	PK00.WRK	No Finish	158
Optional Components:			
Selectronic® 4-Inch Deck Plate	605P400.295	Brushed Nickel	56
Selectronic® 8-Inch Deck Plate	605P800.295	Brushed Nickel	92
Selectronic® Battery Back-Up Kit	PK00.BBU	No Finish	88

Faucets

Selectronic® Power Kit details





Commercial Fittings

Commercial Faucet Accessories

	Description	SKU	Color/Finish	List Price
	Clean IR® 4-Inch Deck Plate <ul style="list-style-type: none"> Covers holes on sink with 4" (102 mm) centers Metal construction with putty plate 	70204P0.002	Polished Chrome	25
		70204P0.295	Brushed Nickel	30
	Clean IR® 8-Inch Deck Plate <ul style="list-style-type: none"> Covers holes on sink with 8-Inch (203 mm) centers Metal construction with putty plate 	70208P0.002	Polished Chrome	32
		70208P0.295	Brushed Nickel	39
	Paradigm® 4-Inch Deck Plate <ul style="list-style-type: none"> Covers holes on sink with 4" (102 mm) centers Metal construction Fixation screw prevents the spout from rotating ¼-Inch (6 mm) fixation bolts with quick spin nuts secure the plate to the deck 	702P400.002	Polished Chrome	64
		702P400.295	Brushed Nickel	75
	NextGen 4-Inch Deck Plate <ul style="list-style-type: none"> Covers holes on sink with 4" (102 mm) centers Metal construction Fixation screw prevents the spout from rotating ¼" (6 mm) fixation bolts with quick spin nuts secure the plate to the deck 	775P400.002	Polished Chrome	58
		775P400.295	Brushed Nickel	70
	NextGen 8-Inch Deck Plate <ul style="list-style-type: none"> Covers holes on sink with 8-Inch (203 mm) centers Metal construction Fixation screw prevents the spout from rotating ¼" (6 mm) fixation bolts with quick spin nuts secure the plate to the deck 	775P800.002	Polished Chrome	86
		775P800.295	Brushed Nickel	102
	Serin® 4-Inch Deck Plate <ul style="list-style-type: none"> Covers holes on sink with 4" (102 mm) centers Brass construction 	206P400.002	Polished Chrome	79
		206P400.295	Brushed Nickel	103
	Serin® 8-Inch Deck Plate <ul style="list-style-type: none"> Covers holes on sink with 8" (203 mm) centers Brass construction 	206P800.002	Polished Chrome	97
		206P800.295	Brushed Nickel	121
	Selectronic® 4-Inch Deck Plate <ul style="list-style-type: none"> Covers holes on sink with 4" (102 mm) centers Metal construction Fixation screw prevents the spout from rotating ¼-inch (6 mm) fixation bolts with quick spin nuts 	605P400.002	Polished Chrome	47
		605P400.295	Brushed Nickel	56
	Selectronic® 8-Inch Deck Plate <ul style="list-style-type: none"> Covers holes on sink with 8" (203 mm) centers Metal construction Fixation screw prevents the spout from rotating ¼-inch (6 mm) fixation bolts with quick spin nuts 	605P800.002	Polished Chrome	77
		605P800.295	Brushed Nickel	92

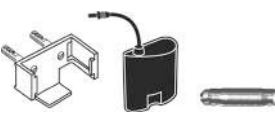



Commercial Fittings

Selectronic® Power Kits and Accessories

	Description	SKU	Color/Finish	List Price
	<p>Selectronic® CR-P2 Lithium Power Kit</p> <ul style="list-style-type: none"> • Selectronic® Flush Valves: 8-year battery life assuming 132 uses per day • NextGen and Paradigm Selectronic® Integrated Faucets: 5-year battery life assuming 132 uses per day • Selectronic® Faucet with Control Box: 4-year battery life assuming 132 uses per day • Includes CR-P2 lithium battery, battery holder and connector locking device • Can be used with Selectronic® Faucets with Control Box and Selectronic® Concealed Flush Valves 	PK00.CRP	No Finish	42
	<p>Selectronic® PWRX® Power Kit</p> <ul style="list-style-type: none"> • Selectronic® Faucets and Flush Valves: 10-year battery life assuming 132 uses per day • NextGen and Paradigm® Faucets: 13-year battery life assuming 132 uses per day • Includes PWRX® battery pack, battery holder and connector locking device • Can be used with all Selectronic® Faucets and Selectronic® Concealed Flush Valves 	PK00.WRK	No Finish	158
	<p>Selectronic® Plug-In AC Power Kit</p> <ul style="list-style-type: none"> • Class 2 UL certified • Input voltage: 100 – 240 VAC, 50/60 Hz • Output voltage: 6 VDC • 6-foot (1,825 mm) long power cord • Includes power supply and connector locking device • Can be used with all Selectronic Base Model Faucets and Flush Valves • One power supply can run up to 15 Selectronic products at one time 	PK00.PAC	No Finish	94
	<p>Selectronic® Hard Wired AC Power Kit</p> <ul style="list-style-type: none"> • Class 2 UL certified • Input voltage: 120 VAC, 60 Hz • Output voltage: 6 VDC • Includes transformer, 10-foot (305 cm) extension cable and connector locking device • Can be used with all Selectronic Base Model Faucets and Flush Valves • One power supply can run up to 15 Selectronic products at one time 	PK00.HAC	No Finish	129
	<p>Selectronic® Multi-AC Power Kit</p> <ul style="list-style-type: none"> • Connect up to 15 Selectronic faucet and/or flush valves at one time in a daisy chain configuration • Can combine faucets and flush valves • Includes 10-foot (305 cm) extension cable and Multi-AC adapter • Can be used with all Selectronic Base Model Faucets and Flush Valves • AC POWER KIT MUST BE PURCHASED SEPARATELY 	PK00.MAC	No Finish	72
	<p>Selectronic® Remote Control - Version 2.0</p> <ul style="list-style-type: none"> • Easily change adjust parameters or access special features • Quick adjustment for easy customization • No tools required • Eliminates the need for to open faucet control box or remove flush valve cover • Can be used to program all Selectronic faucets and flush valves 	605XRCW		438

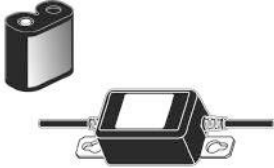
Commercial Fittings

Selectronic® Power Kits and Accessories

	Description	SKU	Color/Finish	List Price
	<p>Selectronic® Battery Back-Up Kit</p> <ul style="list-style-type: none"> • Allows Selectronic® AC-powered products to continue operating during a power failure • Automatically switches to battery power without delay or sensor reset • Installs between Selectronic product and AC power supply • Includes CR-P2 lithium battery with 10-year shelf life • Fail-Safe operation. Product automatically shuts off upon loss of power or dead battery • AC POWER KIT MUST BE PURCHASED SEPARATELY 	PK00.BBU	No Finish	88
	<p>Selectronic Thermostatic Mixing Valve, ASSE 1070 Certified</p> <ul style="list-style-type: none"> • Anti-scald protection • ASSE 1070 certified • Integral check valves prevent cross-flow • Modular design attaches directly to Selectronic faucet control box • 20" long braided flexible hose with 3/8" compression connections 	605XTMV1070	No Finish	239
	<p>Battery</p> <ul style="list-style-type: none"> • Can be used with all Selectronic® faucets and flush valves • Can be used with Serin® sensor-operated faucets • Lithium 6V CR-P2 	A923654-0070A	No Finish	35
	<p>PWRX® Battery</p> <ul style="list-style-type: none"> • Can be used with all PWRX® faucets and flush valves • 10-year battery life when used with Selectronic Faucets and Flush valves • 13-year battery life when used with NextGen and Paradigm Faucets 	M950361-0070A	No Finish	153
	<p>Hard-Wired AC Power Supply</p> <ul style="list-style-type: none"> • Class 2 UL certified • Operates at 120 VAC, 60 Hz • IP65 water-tight output connector • One power supply can run up to 15 Selectronic products • Can be used with all Selectronic® Base Model Faucets and Flush Valves 	M950527-0070A	No Finish	84
	<p>Plug-In AC Power Supply with 6' (183 cm) Cord</p> <ul style="list-style-type: none"> • Class 2 UL certified • Operates at 100 - 240 VAC, 50/60 Hz • IP65 water-tight connector • One power supply can run up to 15 Selectronic products at one time • Can be used with all Selectronic Base Model Faucets and Flush Valves 	M950338-0070A	No Finish	72

Commercial Fittings

Metering Faucets – 1.0 gpm/3.8 Lpm



- Ideal for public restrooms
- Automatic shut-off stops water and energy waste
- Vandal-resistant cast brass construction
- Factory set for a maximum of 0.17 gallons per cycle
- Optional grid drain, mixing valve and deck plates are available (sold separately)
- 1.0 gpm/3.8 Lpf pressure-compensating VR aerator



Description	SKU	Color	List Price
Metering Pillar Tap Faucet With Extended Spout 1.0 gpm/3.8 Lpf	1340109.002	Polished Chrome	166
Optional Components:			
Mechanical Mixing Valve	▷021943-0070A	No Finish	92
Selectronic® 4-Inch Deck Plate	605P400.002	Polished Chrome	47
Selectronic® 8-Inch Deck Plate	605P800.002	Polished Chrome	77



- Ideal for public restrooms
- Automatic shut-off stops water and energy waste
- Vandal-resistant cast brass construction
- Factory set for a maximum of 0.17 gallons per cycle
- Optional grid drain available (sold separately)
- 1.0 gpm/3.8 Lpf pressure-compensating VR aerator



Description	SKU	Color	List Price
Metering 4-Inch Centerset 2-Handle Faucet 1.0 gpm/3.8 Lpf	1340225.002	Polished Chrome	313



- Ideal for public restrooms
- Automatic shut-off stops water and energy waste
- Vandal-resistant cast brass construction
- Factory set for a maximum of 0.17 gallons per cycle (gpc)
- Optional grid drain available (sold separately)
- 1.0 gpm/3.8 Lpf pressure-compensating VR aerator



Description	SKU	Color	List Price
Metering 8-Inch Widespread 2-Handle Faucet 1.0 gpm/3.8 Lpf	1340825.002	Polished Chrome	402

Commercial Fittings

Metering Faucets – 0.5 gpm/1.9 Lpm



- Ideal for public restrooms
- Automatic shut-off stops water and energy waste
- Vandal-resistant cast brass construction
- Factory set for a maximum of 0.09 gallon flow per activation
- Optional grid drain, mixing valve and deck plates are available (sold separately)
- 0.5 gpm/1.9 Lpf pressure-compensating VR multi-laminar spray



Description	SKU	Color	List Price
Metering Pillar Tap Faucet With Extended Spout 0.5 gpm/1.9 Lpf	1340119.002	Polished Chrome	166
Optional Components:			
Mechanical Mixing Valve	▷021943-0070A	No Finish	92
Selectronic® 4-Inch Deck Plate	605P400.002	Polished Chrome	47
Selectronic® 8-Inch Deck Plate	605P800.002	Polished Chrome	77



- Ideal for public restrooms
- Automatic shut-off stops water and energy waste
- Vandal-resistant cast brass construction
- Factory set for a maximum of 0.09 gallon flow per activation
- Optional grid drain available (sold separately)
- 0.5 gpm/1.9 Lpf pressure-compensating VR multi-laminar spray



Description	SKU	Color	List Price
Metering 4-Inch Centerset 2-Handle Faucet 0.5 gpm/1.9 Lpf	1340227.002	Polished Chrome	313



- Ideal for public restrooms
- Automatic shut-off stops water and energy waste
- Vandal-resistant cast brass construction
- Factory set for a maximum of 0.09 gallon flow per activation
- Optional grid drain available (sold separately)
- 0.5 gpm/1.9 Lpf pressure-compensating VR multi-laminar spray







Description	SKU	Color	List Price
Metering 8-Inch Widespread 2-Handle Faucet 0.5 gpm/1.9 Lpf	1340827.002	Polished Chrome	402

▷ Parts Program





Commercial Fittings

Monterrey® Single Control Cast Centerset Faucets

	Description	SKU	Color/Finish	List Price
   	 <p>Monterrey® Cast 4-Inch Centerset Single-Handle Faucet with Metal Pop-Up Drain, 1.2 gpm/5.7 Lpm</p> <ul style="list-style-type: none"> • Cast brass centerset faucet with metal lever handle • Washerless ceramic disc valve cartridge assures drip-free performance • ½" (13 mm) male threaded inlet shanks with quick spin nuts • Adjustable Hot Limit Safety Stop helps prevent accidental scalding • 1.2 gpm/4.5 Lpf pressure-compensating, vandal-resistant aerator • With metal pop-up drain • Replaces 6114110.002 	6114117.002	Polished Chrome	258
   	 <p>Monterrey® Cast 4-Inch Centerset Single-Handle Faucet, Less Drain, 1.2 gpm/4.5 Lpm</p> <ul style="list-style-type: none"> • Cast brass centerset faucet with metal lever handle • Washerless ceramic disc valve cartridge assures drip-free performance • ½" (13 mm) male threaded inlet shanks with quick spin nuts • Adjustable Hot Limit Safety Stop helps prevent accidental scalding • 1.2 gpm/4.5 Lpf pressure-compensating, vandal-resistant aerator • Less drain, rod and hole • Replaces 6114111.002 	6114118.002	Polished Chrome	234
   	 <p>Monterrey® Cast 4-Inch Centerset Single-Handle Faucet with Metal Pop-Up Drain, 0.5 gpm/1.9 Lpm</p> <ul style="list-style-type: none"> • Cast brass centerset faucet with metal lever handle • Washerless ceramic disc valve cartridge assures drip-free performance. • ½" (13 mm) male threaded inlet shanks with quick spin nuts • Adjustable Hot Limit Safety Stop helps prevent accidental scalding • 0.5 gpm/1.9 Lpm pressure-compensating, vandal-resistant multi-laminar spray • With metal pop-up drain • Replaces 6114115.002 	6114119.002	Polished Chrome	258
   	 <p>Monterrey® Cast 4-Inch Centerset Single-Handle Faucet, Less Drain, 0.5 gpm/1.9 Lpm</p> <ul style="list-style-type: none"> • Cast brass centerset faucet with metal lever handle • Washerless ceramic disc valve cartridge assures drip-free performance. • ½" (13 mm) male threaded inlet shanks with quick spin nuts • Adjustable Hot Limit Safety Stop helps prevent accidental scalding • 0.5 gpm/1.9 Lpm pressure-compensating vandal-resistant, multi-laminar spray • Less drain, rod and hole • Replaces 6114116.002 	6114120.002	Polished Chrome	234



















Commercial Fittings

Monterrey® Faucets for CALGreen® – 0.35 gpm/1.3 Lpm

	Description	SKU	Color/Finish	List Price
	<p>Monterrey® 4-Inch Centerset Cast Faucet With Wrist Blade Handles 0.35 gpm/1.3 Lpm</p> <ul style="list-style-type: none"> • Cast brass spout with 3-¾" (95 mm) reach • Washerless ceramic disc valves assure drip-free performance • ½" (13 mm) male threaded inlet shanks with brass coupling nuts • Vandal-resistant wrist blade handles with red and blue indicators • 0.35 gpm/1.3 Lpm pressure-compensating VR multi-laminar spray 	<p>5500174.002</p> <p>ADA CEC</p>	<p>Polished Chrome</p>	<p>219</p> <p>MAP</p>
	<p>Monterrey® 4-Inch Centerset Gooseneck Faucet With Wrist Blade Handles 0.35 gpm/1.3 Lpm</p> <ul style="list-style-type: none"> • Field-convertible rigid/swivel gooseneck spout with 5" (127 mm) reach • Washerless ceramic disc valves assure drip-free performance • ½" (13 mm) male threaded inlet shanks with brass coupling nuts • Vandal-resistant wrist handles with red and blue indicators • 0.35 gpm/1.3 Lpm pressure-compensating VR multi-laminar spray 	<p>7500174.002</p> <p>ADA CEC</p>	<p>Polished Chrome</p>	<p>232</p> <p>MAP</p>
	<p>Monterrey® 8-Inch Widespread Cast Faucet With Wrist Blade Handles 0.35 gpm/1.3 Lpm</p> <ul style="list-style-type: none"> • Cast brass spout with 4-1/16" (103 mm) reach • Cast brass valve bodies with 8" (203 mm) rigid copper connections • ½" (13 mm) male threaded inlet shanks with brass coupling nuts • Washerless ceramic disc valves assure drip-free performance • Vandal-resistant wrist blade handles with red and blue indicators • 0.35 gpm/1.3 Lpm pressure-compensating VR multi-laminar spray 	<p>6500174.002</p> <p>ADA CEC</p>	<p>Polished Chrome</p>	<p>300</p> <p>MAP</p>
	<p>Monterrey® 8-Inch Widespread Gooseneck Faucet With Wrist Blade Handles 0.35 gpm/1.3 Lpm</p> <ul style="list-style-type: none"> • Field-convertible rigid/swivel gooseneck spout with 5" (127 mm) reach • Cast brass valve bodies with 8" (203 mm) rigid copper connections • ½" (13 mm) male threaded inlet shanks with brass coupling nuts • Washerless ceramic disc valves assure drip-free performance • Vandal-resistant wrist blade handles with red and blue indicators • 0.35 gpm/1.3 Lpm pressure-compensating VR multi-laminar spray 	<p>6540174.002</p> <p>ADA CEC</p>	<p>Polished Chrome</p>	<p>316</p> <p>MAP</p>

Commercial Fittings









Monterrey® Widespread Faucets

	Description	SKU	Color/Finish	List Price
 	<p>Monterrey® 8-Inch Widespread Cast Faucet With Lever Handles 1.5 gpm/5.7 Lpm</p> <ul style="list-style-type: none"> • Cast brass spout with 4-1/16" (103 mm) reach • Cast brass valve bodies with 8" (203 mm) rigid copper connections • 1/2" (13 mm) male threaded inlet shanks with brass coupling nuts • Washerless ceramic disc valves assure drip-free performance • Vandal-resistant lever handles with red and blue indicators • 1.5 gpm/5.7 Lpm pressure-compensating aerator 	 6500140.002	Polished Chrome	282 
 	<p>Monterrey® 8-Inch Widespread Cast Faucet With Wrist Blade Handles 1.5 gpm/5.7 Lpm</p> <ul style="list-style-type: none"> • Cast brass spout with 4-1/16" (103 mm) reach • Cast brass valve bodies with 8" (203 mm) rigid copper connections • 1/2" (13 mm) male threaded inlet shanks with brass coupling nuts • Washerless ceramic disc valves assure drip-free performance • Vandal-resistant wrist blade handles with red and blue indicators • 1.5 gpm/5.7 Lpm pressure-compensating aerator 	 6500170.002	Polished Chrome	305 
 	<p>Monterrey® 8-Inch Widespread Cast Faucet With Lever Handles 0.5 gpm/1.9 Lpm</p> <ul style="list-style-type: none"> • Cast brass spout with 4-1/16" (103 mm) reach • Cast brass valve bodies with 8" (203 mm) rigid copper connections • 1/2-inch (13 mm) male threaded inlet shanks with brass coupling nuts • Washerless ceramic disc valves assure drip-free performance • Vandal-resistant lever handles with red and blue indicators • 0.5 gpm/1.9 Lpm pressure-compensating VR multi-laminar spray 	  6500145.002	Polished Chrome	293 
 	<p>Monterrey® 8-Inch Widespread Cast Faucet With Wrist Blade Handles 0.5 gpm/1.9 Lpm</p> <ul style="list-style-type: none"> • Cast brass spout with 4-1/16" (103 mm) reach • Cast brass valve bodies with 8" (203 mm) rigid copper connections • 1/2" (13 mm) male threaded inlet shanks with brass coupling nuts • Washerless ceramic disc valves assure drip-free performance • Vandal-resistant wrist blade handles with red and blue indicators • 0.5 gpm/1.9 Lpm pressure-compensating VR multi-laminar spray 	  6500175.002	Polished Chrome	318 

Faucets

Commercial Fittings





Monterrey® Widespread Faucets – 1.5 gpm/5.7 Lpm

	Description	SKU	Color/Finish	List Price
 	<p>Monterrey® 8-Inch Widespread Gooseneck Faucet With Lever Handles 1.5 gpm/5.7 Lpm</p> <ul style="list-style-type: none"> • Field-convertible rigid/swivel gooseneck spout with 5" (127 mm) reach • Cast brass valve bodies with 8" (203 mm) rigid copper connections • ½" (13 mm) male threaded inlet shanks with brass coupling nuts • Washerless ceramic disc valves assure drip-free performance • Vandal-resistant lever handles with red and blue indicators • 1.5 gpm/5.7 Lpm pressure-compensating aerator 	 6540140.002	Polished Chrome	305 
	<p>Monterrey® 8-Inch Widespread Gooseneck Faucet With Lever Handles 0.5 gpm/1.9 Lpm</p> <ul style="list-style-type: none"> • Field-convertible rigid/swivel gooseneck spout with 5" (127 mm) reach • Cast brass valve bodies with 8" (203 mm) rigid copper connections • ½" (13 mm) male threaded inlet shanks with brass coupling nuts • Washerless ceramic disc valves assure drip-free performance • Vandal-resistant lever handles with red and blue indicators • 0.5 gpm/1.9 Lpm pressure-compensating VR multi-laminar spray 	  6540145.002	Polished Chrome	318 
 	<p>Monterrey® 8-Inch Widespread Gooseneck Faucet With Wrist Blade Handles 1.5 gpm/5.7 Lpm</p> <ul style="list-style-type: none"> • Field-convertible rigid/swivel gooseneck spout with 5" (127 mm) reach • Cast brass valve bodies with 8" (203 mm) rigid copper connections • ½" (13 mm) male threaded inlet shanks with brass coupling nuts • Washerless ceramic disc valves assure drip-free performance • Vandal-resistant wrist blade handles with red and blue indicators • 1.5 gpm/5.7 Lpm pressure-compensating aerator 	 6540170.002	Polished Chrome	325 
	<p>Monterrey® 8-Inch Widespread Gooseneck Faucet With Wrist Blade Handles 0.5 gpm/1.9 Lpm</p> <ul style="list-style-type: none"> • Field-convertible rigid/swivel gooseneck spout with 5" (127 mm) reach • Cast brass valve bodies with 8" (203 mm) rigid copper connections • ½" (13 mm) male threaded inlet shanks with brass coupling nuts • Washerless ceramic disc valves assure drip-free performance • Vandal-resistant wrist blade handles with red and blue indicators • 0.5 gpm/1.9 Lpm pressure-compensating VR multi-laminar spray 	  6540175.002	Polished Chrome	335 

Faucets

Commercial Fittings















Monterrey® Widespread Faucets – 1.5 gpm/5.7 Lpm

	Description	SKU	Color/Finish	List Price
	<p>Monterrey® 8-Inch Widespread 8-inch Reach Gooseneck Faucet With Wrist Blade Handles 1.5 gpm/5.7 Lpm</p> <ul style="list-style-type: none"> • Field-convertible rigid/swivel gooseneck spout with 8" (203 mm) reach • Cast brass valve bodies with 8" (203 mm) rigid copper connections • ½-inch (13 mm) male threaded inlet shanks with brass coupling nuts • Washerless ceramic disc valves assure drip-free performance • Vandal-resistant wrist blade handles with red and blue indicators • 1.5 gpm/5.7 Lpm pressure-compensating aerator 	<p>6540178.002</p>	<p>Polished Chrome</p>	<p>348</p>
	<p>Monterrey® 8-Inch Widespread 8-inch Reach Gooseneck Faucet with Wrist Blade Handles 0.5 gpm/1.9 Lpm</p> <ul style="list-style-type: none"> • Field-convertible rigid/swivel gooseneck spout with 8" (203 mm) reach • Cast brass valve bodies with 8" (203 mm) rigid copper connections • ½" (13 mm) male threaded inlet shanks with brass coupling nuts • Washerless ceramic disc valves assure drip-free performance • Vandal-resistant wrist blade handles with red and blue indicies • 0.5 gpm/1.9 Lpm pressure-compensating VR multi-laminar spray 	<p>6540177.002</p>	<p>Polished Chrome</p>	<p>329</p>
	<p>Monterrey® 8-Inch Widespread Gooseneck Faucet With Wrist Blade Handles 1.5 gpm/5.7 Lpm Rose Spray</p> <ul style="list-style-type: none"> • Field-convertible rigid/swivel gooseneck spout with 5" (127 mm) reach • Cast brass valve bodies with 8" (203 mm) rigid copper connections • ½-inch (13 mm) male threaded inlet shanks with brass coupling nuts • Washerless ceramic disc valves assure drip-free performance • Vandal-resistant wrist blade handles with red and blue indicators • 1.5 gpm/5.7 Lpm pressure-compensating rose spray 	<p>6540171.002</p>	<p>Polished Chrome</p>	<p>333</p>
	<p>Monterrey® 8-Inch Widespread Gooseneck Faucet With Wrist Blade Handles 1.5 gpm/5.7 Lpm With 3rd Water Inlet</p> <ul style="list-style-type: none"> • Third water inlet to connect to pedal valves • Field-convertible rigid/swivel gooseneck spout with 5" (127 mm) reach • Cast brass valve bodies with 8" (203 mm) rigid copper connections • ½" (13 mm) male threaded inlet shanks with brass coupling nuts • Washerless ceramic disc valves assure drip-free performance • Vandal-resistant wrist blade handles with red and blue indicators • 1.5 gpm/5.7 Lpm pressure-compensating aerator 	<p>6540173.002</p>	<p>Polished Chrome</p>	<p>342</p>

Faucets

Commercial Fittings



Monterrey® Widespread Faucets – With Flexible Underbody

	Description	SKU	Color/Finish	List Price
	<p>Monterrey® 8-Inch Widespread Cast Faucet With Wrist Blade Handles 1.5 gpm/5.7 Lpm With Flexible Underbody</p> <ul style="list-style-type: none"> • Cast brass spout with 4-1/16" (103 mm) reach • Cast brass valve bodies with flexible connections for 6" – 12" (152 – 305 mm) C-C • ½" (13 mm) male threaded inlet shanks with brass coupling nuts • Washerless ceramic disc valves assure drip-free performance • Vandal-resistant wrist blade handles with red and blue indicators • 1.5 gpm/5.7 Lpm pressure-compensating aerator 	 6500270.002	Polished Chrome	298 
	<p>Monterrey® 8-Inch Widespread Cast Faucet With Wrist Blade Handles 0.5 gpm/1.9 Lpm With Flexible Underbody</p> <ul style="list-style-type: none"> • Cast brass spout with 4-1/16" (103 mm) reach • Cast brass valve bodies with flexible connections for 6" – 12" (152 – 305 mm) C-C • ½" (13 mm) male threaded inlet shanks with brass coupling nuts • Washerless ceramic disc valves assure drip-free performance • Vandal-resistant wrist blade handles with red and blue indicators • 0.5 gpm/1.9 Lpm pressure-compensating VR multi-laminar spray 	  6500275.002	Polished Chrome	309 
	<p>Monterrey® 8-Inch Widespread Gooseneck Faucet With Wrist Blade Handles 1.5 gpm/5.7 Lpm With Flexible Underbody</p> <ul style="list-style-type: none"> • Field-convertible rigid/swivel gooseneck spout with 5" (127 mm) reach • Cast brass valve bodies with flexible connections. 6" – 12" (152 – 305 mm) C-C • ½" (13 mm) male threaded inlet shanks with brass coupling nuts • Washerless ceramic disc valves assure drip-free performance • Vandal-resistant wrist blade handles with red and blue indicators • 1.5 gpm/5.7 Lpm pressure-compensating aerator 	 6540270.002	Polished Chrome	315 
	<p>Monterrey® 8-Inch Widespread Gooseneck Faucet With Wrist Blade Handles 0.5 gpm/1.9 Lpm With Flexible Underbody</p> <ul style="list-style-type: none"> • Field-convertible rigid/swivel gooseneck spout with 5" (127 mm) reach • Cast brass valve bodies with flexible connections. 6" – 12" (152 – 305 mm) C-C • ½" (13 mm) male threaded inlet shanks with brass coupling nuts • Washerless ceramic disc valves assure drip-free performance • Vandal-resistant wrist blade handles with red and blue indicators • 0.5 gpm/1.9 Lpm pressure-compensating VR multi-laminar spray 	  6540275.002	Polished Chrome	325 

Faucets











Commercial Fittings

Monterrey® Widespread Faucets – With Flexible Underbody

	Description	SKU	Color/Finish	List Price
 <p>Monterrey® 8-Inch Widespread 8-inch Reach Gooseneck Faucet With Wrist Blade Handles 1.5 gpm/5.7 Lpm With Flexible Underbody</p> <ul style="list-style-type: none"> • Field-convertible rigid/swivel gooseneck spout with 8" (203 mm) reach • Cast brass valve bodies with flexible connections. 6" – 12" (152 – 305 mm) C-C • ½" (13 mm) male threaded inlet shanks with brass coupling nuts • Washerless ceramic disc valves assure drip-free performance • Vandal-resistant wrist blade handles with red and blue indicators • 1.5 gpm/5.7 Lpm pressure-compensating aerator 	 6540278.002	Polished Chrome	337	



Monterrey® Centerset Faucets

 <p>Monterrey® 4-Inch Centerset Cast Faucet With Lever Handles 1.5 gpm/5.7 Lpm</p> <ul style="list-style-type: none"> • Cast brass spout with 3-¾" (95 mm) reach • Washerless ceramic disc valves assure drip-free performance • ½" (13 mm) male threaded inlet shanks with brass coupling nuts • Vandal-resistant lever handles with red and blue indicators • 1.5 gpm/5.7 Lpm pressure-compensating aerator 	 5500140.002	Polished Chrome	202
 <p>Monterrey® 4-Inch Centerset Cast Faucet With Wrist Blade Handles 1.5 gpm/5.7 Lpm</p> <ul style="list-style-type: none"> • Cast brass spout with 3-¾" (95 mm) reach • Washerless ceramic disc valves assure drip-free performance • ½" (13 mm) male threaded inlet shanks with brass coupling nuts • Vandal-resistant wrist blade handles with red and blue indicators • 1.5 gpm/5.7 Lpm pressure-compensating aerator 	 5500170.002	Polished Chrome	220
 <p>Monterrey® 4-Inch Centerset Cast Faucet With Lever Handles 0.5 gpm/1.9 Lpm</p> <ul style="list-style-type: none"> • Cast brass spout with 3-¾" (95 mm) reach • Washerless ceramic disc valves assure drip-free performance • ½" (13 mm) male threaded inlet shanks with brass coupling nuts • Vandal-resistant lever handles with red and blue indicators • 0.5 gpm/1.9 Lpm pressure-compensating VR multi-laminar spray 	  5500145.002	Polished Chrome	214
 <p>Monterrey® 4-Inch Centerset Cast Faucet With Wrist Blade Handles 0.5 gpm/1.9 Lpm</p> <ul style="list-style-type: none"> • Cast brass spout with 3-¾" (95 mm) reach • Washerless ceramic disc valves assure drip-free performance • ½" (13 mm) male threaded inlet shanks with brass coupling nuts • Vandal-resistant wrist blade handles with red and blue indicators • 0.5 gpm/1.9 Lpm pressure-compensating VR multi-laminar spray 	  5500175.002	Polished Chrome	232



Commercial Fittings









Monterrey® Centerset Faucets

	Description	SKU	Color/Finish	List Price
 	<p>Monterrey® 4-Inch Centerset Gooseneck Faucet With Lever Handles 1.5 gpm/5.7 Lpm</p> <ul style="list-style-type: none"> • Field-convertible rigid/swivel gooseneck spout with 5" (127 mm) reach • Washerless ceramic disc valves assure drip-free performance • ½" (13 mm) male threaded inlet shanks with brass coupling nuts • Vandal-resistant lever handles with red and blue indicators • 1.5 gpm/5.7 Lpf pressure-compensating aerator 	 7500140.002	Polished Chrome	204 
	<p>Monterrey® 4-Inch Centerset Gooseneck Faucet With Lever Handles 0.5 gpm/1.9 Lpm</p> <ul style="list-style-type: none"> • Field-convertible rigid/swivel gooseneck spout with 5" (127 mm) reach • Washerless ceramic disc valves assure drip-free performance • ½" (13 mm) male threaded inlet shanks with brass coupling nuts • Vandal-resistant lever handles with red and blue indicators • 0.5 gpm/1.9 Lpm pressure-compensating VR multi-laminar spray 	  7500145.002	Polished Chrome	215 
 	<p>Monterrey® 4-Inch Centerset Gooseneck Faucet With Wrist Blade Handles 1.5 gpm/5.7 Lpm</p> <ul style="list-style-type: none"> • Field-convertible rigid/swivel gooseneck spout with 5" (127 mm) reach • Washerless ceramic disc valves assure drip-free performance • ½" (13 mm) male threaded inlet shanks with brass coupling nuts • Vandal-resistant wrist handles with red and blue indicators • 1.5 gpm/5.7 Lpf pressure-compensating aerator 	 7500170.002	Polished Chrome	235 
	<p>Monterrey® 4-Inch Centerset Gooseneck Faucet With Wrist Blade Handles 0.5 gpm/1.9 Lpm</p> <ul style="list-style-type: none"> • Field-convertible rigid/swivel gooseneck spout with 5" (127 mm) reach • Washerless ceramic disc valves assure drip-free performance • ½" (13 mm) male threaded inlet shanks with brass coupling nuts • Vandal-resistant wrist handles with red and blue indicators • 0.5 gpm/1.9 Lpm pressure-compensating VR multi-laminar spray 	  7500175.002	Polished Chrome	246 

Faucets









Commercial Fittings

Monterrey® Faucets – With 6" (152 mm) Wrist Blade Handles

	Description	SKU	Color/Finish	List Price
	<p>Monterrey® 4-Inch Centerset Gooseneck Faucet With 6-inch Wrist Blade Handles 1.5 gpm/5.7 Lpm</p> <ul style="list-style-type: none"> • Field-convertible rigid/swivel gooseneck spout with 5" (127 mm) reach • Washerless ceramic disc valves assure drip-free performance • ½" (13 mm) male threaded inlet shanks with brass coupling nuts • Vandal-resistant 6" (152 mm) wrist handles with red and blue indicators • 1.5 gpm/5.7 Lpf pressure-compensating aerator 	 7500160.002	Polished Chrome	245 
	<p>Monterrey® 8-Inch Widespread Gooseneck Faucet With 6-inch Wrist Blade Handles 1.5 gpm/5.7 Lpm</p> <ul style="list-style-type: none"> • Field-convertible rigid/swivel gooseneck spout with 5" (127 mm) reach • Cast brass valve bodies with 8" (203 mm) rigid copper connections • ½" (13 mm) male threaded inlet shanks with brass coupling nuts • Washerless ceramic disc valves assure drip-free performance • Vandal-resistant 6" (152 mm) wrist blade handles with red and blue indicators • 1.5 gpm/5.7 Lpm pressure-compensating aerator 	 6540160.002	Polished Chrome	327 
	<p>Monterrey® 8-Inch Widespread Gooseneck Faucet With 6-inch Wrist Blade Handles 1.5 gpm/5.7 Lpm</p> <ul style="list-style-type: none"> • Field-convertible rigid/swivel gooseneck spout with 8" (203 mm) reach • Cast brass valve bodies with 8" (203 mm) rigid copper connections • ½" (13 mm) male threaded inlet shanks with brass coupling nuts • Washerless ceramic disc valves assure drip-free performance • Vandal-resistant 6" (152 mm) wrist blade handles with red and blue indicators • 1.5 gpm/5.7 Lpm pressure-compensating aerator 	 6540168.002	Polished Chrome	348 

Commercial Fittings

Monterrey® Faucets – 1.5 gpm/5.7 Lpm – With Laminar Flow in Spout Base





	Description	SKU	Color/Finish	List Price
	<p>Monterrey® 4-Inch Centerset Gooseneck Faucet With Wrist Blade Handles 1.5 gpm/5.7 Lpm Laminar Flow in Spout Base</p> <ul style="list-style-type: none"> • Laminar flow control in spout base. Plain spout end • Field-convertible rigid/swivel gooseneck spout with 5" (127 mm) reach • Washerless ceramic disc valves assure drip-free performance • ½" (13 mm) male threaded inlet shanks with brass coupling nuts • Vandal-resistant wrist blade handles with red and blue indicators • 1.5 gpm/5.7 Lpf pressure-compensating flow regulator 	 7500180.002	Polished Chrome	247 
	<p>Monterrey® 8-inch Widespread Gooseneck Faucet With Wrist Blade Handles 1.5 gpm/5.7 Lpm Laminar Flow in Spout Base</p> <ul style="list-style-type: none"> • Laminar flow control in spout base. Plain spout end • Field-convertible rigid/swivel gooseneck spout with 5" (127 mm) reach • Cast brass valve bodies with 8-inch rigid copper connections • ½-inch (13 mm) male threaded inlet shanks with brass coupling nuts • Washerless ceramic disc valves assure drip-free performance • Vandal-resistant wrist blade handles with red and blue indicators • 1.5 gpm/5.7 Lpm pressure-compensating flow regulator 	 6540180.002	Polished Chrome	338 
	<p>Monterrey® 8-Inch Widespread 8-inch Reach Gooseneck Faucet With Wrist Blade Handles 1.5 gpm/5.7 Lpm Laminar Flow in Spout Base</p> <ul style="list-style-type: none"> • Laminar flow control in spout base. Plain spout end • Field-convertible rigid/swivel gooseneck spout with 8" (203 mm) reach • Cast brass valve bodies with 8-inch rigid copper connections • ½-inch (13 mm) male threaded inlet shanks with brass coupling nuts • Washerless ceramic disc valves assure drip-free performance • Vandal-resistant wrist blade handles with red and blue indicators • 1.5 gpm/5.7 Lpm pressure-compensating flow regulator 	 6540188.002	Polished Chrome	363 





Faucets

All faucets on this page are CEC and CALGreen® compliant.





Commercial Fittings

Monterrey® Faucets – With Limited Swivel Gooseneck Spout

	Description	SKU	Color/Finish	List Price
 	<p>Monterrey® 4-Inch Centerset Gooseneck Faucet With Wrist Blade Handles 1.5 gpm/5.7 Lpm With Limited Swivel</p> <ul style="list-style-type: none"> • Swivel spout is restricted to 140 degrees to eliminate spills behind the sink • Gooseneck spout with 5" (127 mm) reach • Washerless ceramic disc valves assure drip-free performance • ½" (13 mm) male threaded inlet shanks with brass coupling nuts • Vandal-resistant wrist handles with red and blue indicators • 1.5 gpm/5.7 Lpf pressure-compensating aerator 	 7545170.002	Polished Chrome	250 

 	<p>Monterrey® 8-Inch Widespread Gooseneck Faucet With Wrist Blade Handles 1.5 gpm/5.7 Lpm With Limited Swivel</p> <ul style="list-style-type: none"> • Spout swivel is restricted to 140 degrees to eliminate spills behind the sink • Gooseneck spout with 5" (127 mm) reach • Cast brass valve bodies with 8" (203 mm) rigid copper connections • ½" (13 mm) male threaded inlet shanks with brass coupling nuts • Washerless ceramic disc valves assure drip-free performance • Vandal-resistant wrist blade handles with red and blue indicators • 1.5 gpm/5.7 Lpm pressure-compensating aerator 	 6545170.002	Polished Chrome	333 
--	--	---	-----------------	---





Heritage® Pantry Faucet

	<p>Heritage® Single Hole Pantry Faucet With Lever Handle, 1.5 gpm/5.7 Lpm</p> <ul style="list-style-type: none"> • Single supply for cold or tempered water • Brass construction • Brass swivel spout with 5" (127 mm) reach • Washerless ceramic disc valves assure drip-free performance • Metal lever handle • 1.5 gpm/5.7 Lpm pressure-compensating aerator 	  7100241H.002	Polished Chrome	200 
---	--	--	-----------------	---

All faucets on this page are CEC and CALGreen® compliant.

Commercial Fittings

Monterrey® – Top Mount Kitchen Faucets









	Description	SKU	Color/Finish	List Price
	<p>Monterrey® Top Mount Kitchen Faucet With Gooseneck Spout and Lever Handles 1.5 gpm/5.7 Lpf</p> <ul style="list-style-type: none"> • Field-convertible rigid/swivel gooseneck spout with 5" (127 mm) reach • Washerless ceramic disc valves assure drip-free performance • ½" (13 mm) male threaded inlet shanks with brass coupling nuts • Vandal-resistant lever handles with red and blue indicators • 1.5 gpm/5.7 Lpm pressure-compensating aerator • Less spray 	<p>6405140.002</p> <p>ADA CEC</p>	<p>Polished Chrome</p>	<p>254</p> <p>MAP</p>
	<p>Monterrey® Top Mount Kitchen Faucet With Gooseneck Spout and Wrist Blade Handles 1.5 gpm/5.7 Lpf</p> <ul style="list-style-type: none"> • Field-convertible rigid/swivel gooseneck spout with 5" (127 mm) reach • Washerless ceramic disc valves assure drip-free performance • ½" (13 mm) male threaded inlet shanks with brass coupling nuts • Vandal-resistant wrist blade handles with red and blue indicators • 1.5 gpm/5.7 Lpm pressure-compensating aerator • Less spray 	<p>6405170.002</p> <p>ADA CEC</p>	<p>Polished Chrome</p>	<p>267</p> <p>MAP</p>
	<p>Monterrey® Top Mount Kitchen Faucet With Gooseneck Spout and Wrist Blade Handles 1.5 gpm/5.7 Lpf With Spray</p> <ul style="list-style-type: none"> • Field-convertible rigid/swivel gooseneck spout with 8" (203 mm) reach • Washerless ceramic disc valves assure drip-free performance • ½" (13 mm) male threaded inlet shanks with brass coupling nuts • Vandal-resistant wrist blade handles with red and blue indicators • 1.5 gpm/5.7 Lpm pressure-compensating aerator • Color-matched spray 	<p>6409171.002</p> <p>ADA CEC</p>	<p>Polished Chrome</p>	<p>334</p> <p>MAP</p>
	<p>Monterrey® Top Mount Kitchen Faucet With Gooseneck Spout and Wrist Blade Handles 1.5 gpm/5.7 Lpf</p> <ul style="list-style-type: none"> • Field-convertible rigid/swivel gooseneck spout with 8" (203 mm) reach • Washerless ceramic disc valves assure drip-free performance • ½" (13 mm) male threaded inlet shanks with brass coupling nuts • Vandal-resistant wrist blade handles with red and blue indicators • 1.5 gpm/5.7 Lpm pressure-compensating aerator • Less spray 	<p>6409170.002</p> <p>ADA CEC</p>	<p>Polished Chrome</p>	<p>290</p> <p>MAP</p>

Faucets

All faucets on this page are CEC and CALGreen® compliant.

Commercial Fittings

Monterrey® – Top Mount Kitchen Faucets



	Description	SKU	Color/Finish	List Price
	<p>Monterrey® Top Mount Kitchen Faucet With Gooseneck Spout and Wrist Blade Handles 1.5 gpm/5.7 Lpf Laminar Flow in Spout Base</p> <ul style="list-style-type: none"> • Laminar flow control in spout base. Plain spout end • Field-convertible rigid/swivel gooseneck spout with 8" (203 mm) reach • Washerless ceramic disc valves assure drip-free performance • ½" (13 mm) male threaded inlet shanks with brass coupling nuts • Vandal-resistant wrist blade handles with red and blue indicators • 1.5 gpm/5.7 Lpm pressure-compensating flow regulator • Less Spray 	 <p>6409180.002</p>	<p>Polished Chrome</p>	<p>308</p> 
	<p>Monterrey® Top Mount Kitchen Faucet With Tubular Spout and Lever Handles 1.5 gpm/5.7 Lpf Less Spray</p> <ul style="list-style-type: none"> • Tubular swivel spout with 8" (203 mm) reach • Washerless ceramic disc valves assure drip-free performance • ½" (13 mm) male threaded inlet shanks with brass coupling nuts • Vandal-resistant lever handles with red and blue indicators • 1.5 gpm/5.7 Lpm pressure-compensating aerator • Less spray 	 <p>6408140.002</p>	<p>Polished Chrome</p>	<p>264</p> 
	<p>Monterrey® Top Mount Kitchen Faucet With Tubular Spout and Wrist Blade Handles 1.5 gpm/5.7 Lpf Less Spray</p> <ul style="list-style-type: none"> • Tubular swivel spout with 8" (203 mm) reach • Washerless ceramic disc valves assure drip-free performance • ½" (13 mm) male threaded inlet shanks with brass coupling nuts • Vandal-resistant wrist blade handles with red and blue indicators • 1.5 gpm/5.7 Lpm pressure-compensating aerator • Less spray 	 <p>6408170.002</p>	<p>Polished Chrome</p>	<p>278</p> 

Faucets

All faucets on this page are CEC and CALGreen® compliant.

Commercial Fittings

Monterrey® – Bottom Mount Kitchen Faucets





	Description	SKU	Color/Finish	List Price
	<p>Monterrey® Bottom Mount Kitchen Faucet With Gooseneck Spout and Wrist Blade Handles 1.5 gpm/5.7 Lpf With Spray</p> <ul style="list-style-type: none"> • Field-convertible rigid/swivel gooseneck spout with 8" (203 mm) reach • Washerless ceramic disc valves assure drip-free performance • ½" (13 mm) male threaded inlet shanks with brass coupling nuts • Vandal-resistant wrist blade handles with red and blue indicators • 1.5 gpm/5.7 Lpm pressure-compensating aerator • Color-matched spray 	<p>6403171.002</p> <p>ADA CEC</p>	<p>Polished Chrome</p>	<p>346</p> <p>MAP</p>
	<p>Monterrey® Bottom Mount Kitchen Faucet With Gooseneck Spout and Wrist Blade Handles 1.5 gpm/5.7 Lpf</p> <ul style="list-style-type: none"> • Field-convertible rigid/swivel gooseneck spout with 8" (203 mm) reach • Washerless ceramic disc valves assure drip-free performance • ½" (13 mm) male threaded inlet shanks with brass coupling nuts • Vandal-resistant wrist blade handles with red and blue indicators • 1.5 gpm/5.7 Lpm pressure-compensating aerator • Less spray 	<p>6403170.002</p> <p>ADA CEC</p>	<p>Polished Chrome</p>	<p>311</p> <p>MAP</p>
	<p>Monterrey® Bottom Mount Kitchen Faucet With Tubular Spout and Wrist Blade Handles 1.5 gpm/5.7 Lpm</p> <ul style="list-style-type: none"> • Tubular swivel spout with 9-½" (241 mm) reach • Washerless ceramic disc valves assure drip-free performance • ½" (13 mm) male threaded inlet shanks with brass coupling nuts • Vandal-resistant wrist blade handles with red and blue indicators • 1.5 gpm/5.7 Lpm pressure-compensating aerator • Less spray 	<p>6404170.002</p> <p>ADA CEC</p>	<p>Polished Chrome</p>	<p>307</p> <p>MAP</p>

Faucets

All faucets on this page are CEC and CALGreen® compliant.

















Commercial Fittings

Monterrey® – Kitchen Faucets

	Description	SKU	Color/Finish	List Price
	<p>Monterrey® Single-Handle Gooseneck Kitchen Faucet 1.5 gpm/5.7 Lpm</p> <ul style="list-style-type: none"> • Remote valve • Field-convertible rigid/swivel gooseneck spout with 8" (203 mm) reach • Washerless ceramic disc valve cartridge assures drip-free performance. • Metal lever handle with red/blue index • 1.5 gpm/5.7 Lpm pressure-compensating aerator • Less spray 	<p>6114380.002</p> <p>   </p>	<p>Polished Chrome</p>	<p>346</p> <p>  </p>

















Commercial Fittings

Reliant 3® – Bath Faucets and Bath/Shower Trim Kits

	Description	SKU	Color/Finish	List Price
 	Reliant 3® 4-Inch Centerset Single-Handle Bathroom Faucet 1.2 gpm/4.5 L/min With Lever Handle <ul style="list-style-type: none"> • Water-conserving 1.2 gpm/4.5 L/min pressure-compensating aerator • 47 mm ceramic disc valve cartridge with an adjustable Hot Limit Safety Stop • Cast brass waterway with flexible supply hoses • Braided flexible supply hoses with 3/8" (10 mm) compression connectors • Red/Blue index button included • Metal lever handle • Metal Speed Connect® pop-up drain 	 7385000.002	Polished Chrome	196
		 7385000.295	Brushed Nickel	275
	Reliant 3® 4-Inch Centerset Single-Handle Bathroom Faucet 1.2 gpm/4.5 L/min With Lever Handles <ul style="list-style-type: none"> • Water-conserving 1.2 gpm/4.5 L/min pressure-compensating aerator • 47 mm ceramic disc valve cartridge with an adjustable Hot Limit Safety Stop • Extra long braided flexible supply hoses with 3/8" (10 mm) compression connectors • Red/Blue index button included • Metal lever handle • Metal Speed Connect® pop-up drain 	 7385LS000.002	Polished Chrome	196
 	Reliant 3® 4-Inch Centerset Single-Handle Bathroom Faucet 1.2 gpm/4.5 L/min With Lever Handle <ul style="list-style-type: none"> • Water-conserving 1.2 gpm/4.5 L/min pressure-compensating aerator • 47 mm ceramic disc valve cartridge with an adjustable Hot Limit Safety Stop • Braided flexible supply hoses with 3/8" (10 mm) compression connectors • Red/Blue index button included • Indexed Red/Blue metal lever handle • Metal Speed Connect® pop-up drain 	 7385008.002	Polished Chrome	201
				
 	Reliant 3® 4-Inch Centerset Single-Handle Bathroom Faucet 1.2 gpm/4.5 L/min With Lever Handle <ul style="list-style-type: none"> • Water-conserving 1.2 gpm/4.5 L/min pressure-compensating aerator • 47 mm ceramic disc valve cartridge with an adjustable Hot Limit Safety Stop • Cast brass waterway with flexible supply hoses • Braided flexible supply hoses with 3/8" (10 mm) compression connectors • Red/Blue index button included • Indexed Red/Blue metal lever handle • Grid drain • Less pop-up hole 	 7385003.002	Polished Chrome	196
				
 	Reliant 3® 4-Inch Centerset Single-Handle Bathroom Faucet 0.5 gpm/1.9 L/min With Lever Handle <ul style="list-style-type: none"> • Water-conserving 0.5 gpm/1.9 L/min pressure-compensating aerator • 47 mm ceramic disc valve cartridge with an adjustable Hot Limit Safety Stop • Cast brass waterway • Braided flexible supply hoses with 3/8" (10 mm) compression connectors • Red/Blue index button included • Indexed Red/Blue metal lever handle • Metal Speed Connect® pop-up drain 	 7385LHV05003.002	Polished Chrome	196



Commercial Fittings

Reliant 3® – Bath Faucets and Bath/Shower Trim Kits

	Description	SKU	Color/Finish	List Price
 	<p>Reliant 3® 4-Inch Centerset Single-Handle Bathroom Faucet 1.2 gpm/4.5 L/min With Lever Handle</p> <ul style="list-style-type: none"> • Water-conserving 1.2 gpm/4.5 L/min pressure-compensating aerator • 47 mm ceramic disc valve cartridge with an adjustable Hot Limit Safety Stop • Cast brass waterway with flexible supply hoses • Braided flexible supply hoses with 3/8" (10 mm) compression connectors • Red/Blue index button included • Indexed Red/Blue metal lever handle • Less drain • Less pop-up rod • With pop-up hole 	  7385007.002	Polished Chrome	177
 	<p>Reliant 3® 4-Inch Centerset Single-Handle Bathroom Faucet 1.2 gpm/4.5 L/min With Lever Handle</p> <ul style="list-style-type: none"> • Water-conserving 1.2 gpm/4.5 L/min pressure-compensating aerator • 47 mm ceramic disc valve cartridge with an adjustable Hot Limit Safety Stop • Cast brass waterway with flexible supply hoses • Braided flexible supply hoses with 3/8" (10 mm) compression connectors • Red/Blue index button included • Indexed Red/Blue metal lever handle • Less drain • Less pop-up rod • Less pop-up hole 	  7385004.002 7385004.295	Polished Chrome Brushed Nickel	177 247
 	<p>Reliant 3® 4-Inch Centerset Single-Handle Bathroom Faucet 0.5 gpm/1.9 L/min With Lever Handle</p> <ul style="list-style-type: none"> • Water-conserving 0.5 gpm/1.9 L/min pressure-compensating aerator spray • 47 mm ceramic disc valve cartridge with adjustable Hot Limit Safety Stop • All metal construction • Vandal-resistant non aerator spray • Cast brass waterway • Braided flexible supply hoses with 3/8" (10 mm) compression connectors • Red/Blue index button included • Indexed Red/Blue metal lever handle • Metal Speed Connect® pop-up drain 	  7385058.002	Polished Chrome	199
 	<p>Reliant 3® 4-Inch Centerset Single-Handle Bathroom Faucet 0.5 gpm/1.9 L/min With Lever Handle</p> <ul style="list-style-type: none"> • Water-conserving 0.5 gpm/1.9 L/min pressure-compensating aerator spray • 47 mm ceramic disc valve cartridge with adjustable Hot Limit Safety Stop • All metal construction • Vandal-resistant non aerator spray • Cast brass waterway • Braided flexible supply hoses with 3/8" (10 mm) compression connectors • Red/Blue index button included • Indexed Red/Blue metal lever handle • Grid drain • Less pop-up hole 	  7385053.002	Polished Chrome	199

Commercial Fittings

Reliant 3® – Bath Faucets and Bath/Shower Trim Kits

	Description	SKU	Color/Finish	List Price
	<p>Reliant 3® 4-Inch Centerset Single-Handle Bathroom Faucet 0.5 gpm/1.9 L/min With Lever Handle</p> <p>ADA CEC</p> <ul style="list-style-type: none"> • Water-conserving 0.5 gpm/1.9 L/min pressure-compensating aerator spray • 47 mm ceramic disc valve cartridge with an adjustable Hot Limit Safety Stop • Cast brass waterway with flexible supply hoses • Vandal-resistant non-aerator spray • Braided flexible supply hoses with 3/8" (10 mm) compression connectors • Indexed Red/Blue metal lever handle • Less drain • Less pop-up hole 	7385050.002	Polished Chrome	180
	<p>Reliant 3® 4-Inch Centerset Single-Handle Bathroom Faucet 1.2 gpm/4.5 L/min With Lever Handle</p> <p>ADA CEC</p> <ul style="list-style-type: none"> • Water-conserving 1.2 gpm/4.5 L/min pressure-compensating aerator spray • 47 mm ceramic disc valve cartridge with adjustable Hot Limit Safety Stop • All metal construction • Cast brass waterway • 3/8" (10 mm) copper supplies with 1/2" (13 mm) male adapters • Metal lever handle • Red/Blue index button included • Less Drain • Less pop-up hole 	7385047.002	Polished Chrome	214

Commercial Fittings

HOW TO ORDER

Choose desired trim kit.



Trim kit with cartridge



Choose rough-in valve with desired connection.



Flash® Shower Rough-In Valve



Fully installed Bath/Shower



	Description	SKU #	Color/Finish	List Price
	Reliant 3® 2.5 gpm/9.5 L/min Tub and Shower Trim Kit With Showerhead, Double Ceramic Pressure Balance Cartridge With Lever Handle <ul style="list-style-type: none"> • Includes Double Ceramic pressure balance cartridge • "Easy Clean" 4-1/2" (115 mm) showerhead, 2.5 gpm/9.5 L/min maximum flow • Shower arm and flange • Metal wall escutcheon • Slip-on diverter tub spout • For use with Flash® shower rough-in valves 	TU385502.002	Polished Chrome	195
		TU385502.295	Brushed Nickel	262
	Reliant 3® 2.5 gpm/9.5 L/min Shower Trim Kit With Showerhead, Double Ceramic Pressure Balance Cartridge With Lever Handle <ul style="list-style-type: none"> • Includes Double Ceramic pressure balance cartridge • "Easy Clean" 4-1/2" (115 mm) showerhead, 2.5 gpm/9.5 L/min maximum flow • Shower arm and flange • Metal wall escutcheon • Metal lever handle • For use with Flash® shower rough-in valves 	TU385501.002	Polished Chrome	156
		TU385501.295	Brushed Nickel	205
	Reliant 3® Valve Only Trim Kit With Double Ceramic Pressure Balance Cartridge With Lever Handle <ul style="list-style-type: none"> • Includes Double Ceramic pressure balance cartridge • Metal wall escutcheon • Metal lever handle • For use with Flash® shower rough-in valves 	TU385500.002	Polished Chrome	109
		TU385500.295	Brushed Nickel	142
	Reliant 3® 1.75 gpm/6.6 L/min Tub and Shower Trim Kit With Double Ceramic Pressure Balance Cartridge With Lever Handle <ul style="list-style-type: none"> • Includes Double Ceramic pressure balance cartridge • Water-saving 3-3/4" (96 mm) 1.75 gpm/6.6 L/min maximum flow • Shower arm and flange • Metal wall escutcheon • Metal lever handle • Slip-on diverter tub spout • For use with Flash® shower rough-in valves 	TU385508.002	Polished Chrome	195

Commercial Fittings

Flash® Rough-In Valves

	Description	SKU	Color/Finish	List Price
	<p>Flash® Shower Rough-In Valve With Universal Inlets/Outlets</p> <ul style="list-style-type: none"> • ½" (13 mm) male NPT/Sweat inlets/outlets accept ½" copper, ½" iron pipe, PEX or CPVC adapters • Cast DZR brass valve body • Flow rate: 5.1 gpm @ 45 psi* • Back-to-back capability • Includes flush plug with stainless steel ring • Cartridge ships with trim • For use with TU series pressure balance bath/shower trim kits 	RU101	No Finish	72
	<p>Flash® Shower Rough-In Valve With Universal Inlets/Outlets With Screwdriver Stops</p> <ul style="list-style-type: none"> • ½" (13 mm) male NPT/Sweat inlets/outlets accept ½" copper, ½" iron pipe, PEX or CPVC adapters • Cast DZR brass valve body • Flow rate: 5.1 gpm @ 45 psi* • Back-to-back capability • Includes flush plug with stainless steel ring • Includes screwdriver stops for easy servicing at the valve • For use with TU series pressure balance bath/shower trim kits 	RU101SS	No Finish	103
	<p>Flash® Shower Rough-In Valve With Stub-Outs</p> <ul style="list-style-type: none"> • ½" (13 mm) Stub-out inlets/outlets accept ½" press-connect fittings • Cast DZR brass valve body • Flow rate: 5.1 gpm @ 45 psi* • Back-to-back capability • Includes flush plug with stainless steel ring • Cartridge ships with trim • For use with TU series pressure balance bath/shower trim kits 	RU102	No Finish	72
	<p>Flash® Shower Rough-In Valve With Stub-Outs With Screwdriver Stops</p> <ul style="list-style-type: none"> • ½" (13 mm) Stub-out inlets/outlets accept ½" press-connect fittings • Cast DZR brass valve body • Flow rate: 5.1 gpm @ 45 psi* • Back-to-back capability • Includes flush plug with stainless steel ring • Includes screwdriver stops for easy servicing at the valve • Cartridge ships with trim • For use with TU series pressure balance bath/shower trim kits 	RU102SS	No Finish	103
	<p>Flash® Shower Rough-In Valve With PEX Inlets/Universal Outlets for Crimp Ring System</p> <ul style="list-style-type: none"> • ½" (3 mm) PEX crimp inlets/Universal outlets (ASTM F1807) • Cast DZR brass valve body • Flow rate: 5.1 gpm @ 45 psi* • Back-to-back capability • Includes flush plug with stainless steel ring • Cartridge ships with trim • For use with TU series pressure balance bath/shower trim kits 	RU107	No Finish	72

*When combined with Double Ceramic pressure balance cartridge.

Commercial Fittings





Flash® Rough-In Valves

	Description	SKU	Color/Finish	List Price
	<p>Flash® Shower Rough-In Valve With PEX Inlets/Universal Outlets With Screwdriver Stops for Crimp Ring System</p> <ul style="list-style-type: none"> • ½" (13 mm) PEX crimp inlets/Universal outlets (ASTM F1807) • Cast DZR brass valve body • Flow rate: 5.1 gpm @ 45 psi* • Back-to-back capability • Includes flush plug with stainless steel ring • Includes screwdriver stops for easy servicing at the valve • Cartridge ships with trim • For use with TU series pressure balance bath/shower trim kits 	RU107SS	No Finish	103 
	<p>Flash® Shower Rough-In Valve With PEX Inlet Elbows/Universal Outlets for Crimp Ring System</p> <ul style="list-style-type: none"> • ½" (13 mm) PEX crimp elbow inlets/Universal outlets (ASTM F1807) • Cast DZR brass valve body • Flow rate: 5.1 gpm @ 45 psi* • Back-to-back capability • Includes flush plug with stainless steel ring • Cartridge ships with trim • For use with TU series pressure balance bath/shower trim kits 	RU107E	No Finish	95 
	<p>Flash® Shower Rough-In Valve With PEX Inlet Elbows/Universal Outlets With Screwdriver Stops for Crimp Ring System</p> <ul style="list-style-type: none"> • ½" (13 mm) PEX crimp elbow inlets/Universal outlets (ASTM F1807) • Cast DZR brass valve body • Flow rate: 5.1 gpm @ 45 psi* • Back-to-back capability • Includes flush plug with stainless steel ring • Includes screwdriver stops for easy servicing at the valve • Cartridge ships with trim • For use with TU series pressure balance bath/shower trim kits 	RU107ESS	No Finish	125 
	<p>Flash® Shower Rough-In Valve With PEX Inlets/Universal Outlets for Cold Expansion System</p> <ul style="list-style-type: none"> • ½" (13 mm) PEX cold expansion inlets/Universal outlets (ASTM F1960) • Cast DZR brass valve body • Flow rate: 5.1 gpm @ 45 psi* • Back-to-back capability • Includes flush plug with stainless steel ring • Cartridge ships with trim • For use with TU series pressure balance bath/shower trim kits 	RU108	No Finish	72 
	<p>Flash® Shower Rough-In Valve With PEX Inlets/Universal Outlets With Screwdriver Stops for Cold Expansion System</p> <ul style="list-style-type: none"> • ½" (13 mm) PEX cold expansion inlets/Universal outlets (ASTM F1960) • Cast DZR brass valve body • Flow rate: 5.1 gpm @ 45 psi* • Back-to-back capability • Includes flush plug with stainless steel ring • Includes screwdriver stops for easy servicing at the valve • For use with TU series pressure balance bath/shower trim kits 	RU108SS	No Finish	103 

*When combined with Double Ceramic pressure balance cartridge.

Commercial Fittings

Flash® Rough-In Valves

	Description	SKU	Color/Finish	List Price
	<p>Flash® Shower Rough-In Valve With PEX Inlet Elbows/Universal Outlets for Cold Expansion System</p> <ul style="list-style-type: none"> • ½" (13 mm) PEX cold expansion elbow inlets/ Universal outlets (ASTM F1960) • Cast DZR brass valve body • Flow rate: 5.1 gpm @ 45 psi* • Back-to-back capability • Includes flush plug with stainless steel ring • Cartridge ships with trim • For use with TU series pressure balance bath/ shower trim kits 	RU108E	No Finish	95
	<p>Flash® Shower Rough-In Valve With PRX Inlet Elbows/Universal Outlets With Screwdriver Stops for Cold Expansion System</p> <ul style="list-style-type: none"> • ½" (13 mm) PEX cold expansion elbow inlets/ Universal outlets (ASTM F1960) • Cast DZR brass valve body • Flow rate: 5.1 gpm @ 45 psi* • Back-to-back capability • Includes flush plug with stainless steel ring • Includes screwdriver stops for easy servicing at the valve • Cartridge ships with trim • For use with TU series pressure balance bath/ shower trim kits 	RU108ESS	No Finish	125
	<p>Flash® Shower Rough-In Valve With CPVC Inlets/Universal Outlets</p> <ul style="list-style-type: none"> • ½" (13 mm) CPVC inlets/Universal outlets • Cast DZR brass valve body • Flow rate: 5.1 gpm @ 45 psi* • Back-to-back capability • Includes flush plug with stainless steel ring • Cartridge ships with trim • For use with TU series pressure balance bath/ shower trim kits 	RU109	No Finish	95
	<p>Flash® Shower Rough-In Valve With CPVC Inlets/Universal Outlets With Screwdriver Stops</p> <ul style="list-style-type: none"> • ½" (13 mm) CPVC inlets/Universal outlets • Cast DZR brass valve body • Flow rate: 5.1 gpm @ 45 psi* • Back-to-back capability • Includes flush plug with stainless steel ring • Includes screwdriver stops for easy servicing at the valve • Cartridge ships with trim • For use with TU series pressure balance bath/ shower trim kits 	RU109SS	No Finish	125



*When combined with Double Ceramic pressure balance cartridge.

Commercial Fittings

Commercial Shower System Kits – 2.5 gpm/9.5 Lpm

	Description	SKU	Color/Finish	List Price
	<p>Commercial Shower System Trim Kit 2.5 gpm/9.5 Lpm With 36-Inch Slide Bar and Hand Shower</p> <ul style="list-style-type: none"> • For Flash® shower rough-in valves with choice of connections (sold separately) • Includes 3-function hand shower with pause feature • Pause Feature: Non-positive shut-off button on handle reduces flow to a trickle to meet ADA requirement • 36" slide bar • Metal wall escutcheon with metal lever handle. Red/blue indicator ring • 2.5 gpm/9.5 Lpm maximum flow rate 	TU662221.002	Polished Chrome	345



	<p>Commercial Shower System Trim Kit 2.5 gpm/9.5 Lpm With 36-Inch Slide Bar, Hand Shower and Showerhead</p> <ul style="list-style-type: none"> • For Flash® shower rough-in valves with choice of connections (sold separately) • 2-way rough diverter valve (R422 - sold separately) • Includes 3-function hand shower with pause feature • Pause Feature: Non-positive shut-off button on handle reduces flow to a trickle to meet ADA requirement • 2-way diverter valve trim kit • Fixed showerhead with arm and flange • 36" slide bar • Metal wall escutcheon with metal lever handle. Red/blue indicator ring • 2.5 gpf/9.5 Lpm maximum flow rate 	TU662223.002	Polished Chrome	458
---	--	--------------	-----------------	-----



Commercial Fittings

Commercial Shower System Kits – 2.5 gpm/9.5 Lpm

Description	SKU	Color/Finish	List Price
Commercial Shower System Trim Kit 2.5 gpm/9.5 Lpm with 36-Inch Slide Bar, Hand Shower, Showerhead and Tub Spout	TU662224.002	Polished Chrome	494



- For Flash® shower rough-in valves with choice of connections (sold separately). 3-way rough diverter valve (R433) sold separately
- Includes 3-function hand shower with pause feature
- Pause Feature: Non-positive shut-off button on handle reduces flow to a trickle to meet ADA requirement
- 3-way diverter valve trim kit
- Fixed showerhead with arm and flange
- Tub spout
- 36" slide bar
- Metal wall escutcheon with metal lever handle. Red / blue indicator ring
- 2.5 gpm/9.5 Lpm maximum flow rate

Commercial Shower System Trim Kit 2.5 gpm/9.5 Lpm With 36-Inch Slide Bar, Hand Shower and Tub Spout	TU662225.002	Polished Chrome	390
--	--------------	-----------------	-----



- For Flash® shower rough-in valves with choice of connections (sold separately)
- Includes 3-function hand shower with pause feature
- Pause Feature: Non-positive shut-off button on handle reduces flow to a trickle to meet ADA requirement
- Diverter tub spout
- 36" slide bar
- Metal wall escutcheon with metal lever handle. Red/blue indicator ring
- 2.5 gpf/9.5 Lpm maximum flow rate



Commercial Fittings



Commercial Shower System Kits – 1.5 gpm/5.7 Lpm



	Description	SKU	Color/Finish	List Price
	<p>Commercial Shower System Trim Kit 1.5 gpm/5.7 Lpm With 36-Inch Slide Bar and Hand Shower</p> <ul style="list-style-type: none"> • For Flash® shower rough-in valves with choice of connections (sold separately) • Includes 3-function hand shower with pause feature • Pause Feature: Non-positive shut-off button on handle reduces flow to a trickle to meet ADA requirement • 36" slide bar • Metal wall escutcheon with metal lever handle. Red/blue indicator ring • 1.5 gpf/5.7 Lpm maximum flow rate 	<p>CEC TU662211.002</p>	<p>Polished Chrome</p>	<p>345</p>
	<p>Commercial Shower System Trim Kit 1.5 gpm/5.7 Lpm With 36-Inch Slide Bar, Hand Shower and Showerhead</p> <ul style="list-style-type: none"> • For Flash® shower rough-in valves with choice of connections (sold separately) • 2-way rough diverter valve (R422 - sold separately) • Includes 3-function hand shower with pause feature • Pause Feature: Non-positive shut-off button on handle reduces flow to a trickle to meet ADA requirement • 2-way diverter valve trim kit • Fixed showerhead with arm and flange • 36" slide bar • Metal wall escutcheon with metal lever handle. Red/blue indicator ring • 1.5 gpf/5.7 Lpm maximum flow rate 	<p>CEC TU662213.002</p>	<p>Polished Chrome</p>	<p>458</p>

Shower Systems

Commercial Fittings

Commercial Shower System Kits – 1.5 gpm/5.7 Lpm

	Description	SKU	Color/Finish	List Price
	<p>Commercial Shower System Trim Kit 1.5 gpm/5.7gpm with 36" Slide Bar, Hand Shower, Showerhead and Tub Spout</p> <ul style="list-style-type: none"> • For Flash® shower rough-in valves with choice of connections (sold separately). 3-way rough diverter valve (R33) sold separately • Includes 3-function hand shower with pause feature • Pause Feature: Non-positive shut-off button on handle reduces flow to a trickle to meet ADA requirement • 3-way diverter valve trim kit • Fixed showerhead with arm and flange • Tub spout • 36" slide bar • Metal wall escutcheon with metal lever handle. Red / blue indicator ring • 1.5 gpf/5.7 Lpm maximum flow rate 	 TU662214.002	Polished Chrome	494

	<p>Commercial Shower System Trim Kit 1.5 gpm/5.7 Lpm With 36-Inch Slide Bar, Hand Shower and Tub Spout</p> <ul style="list-style-type: none"> • For Flash® shower rough-in valves with choice of connections (sold separately) • Includes 3-function hand shower with pause feature • Pause Feature: Non-positive shut-off button on handle reduces flow to a trickle to meet ADA requirement • Diverter tub spout • 36" slide bar • Metal wall escutcheon with metal lever handle. Red/blue indicator ring • 1.5 gpf/5.7 Lpm maximum flow rate 	 TU662215.002	Polished Chrome	390 
--	---	---	-----------------	---

Commercial Fittings













Commercial Shower System Kits With Slide/Grab Bar – 1.5 gpm/5.7 Lpm

	Description	SKU	Color/Finish	List Price
	<p>Commercial Shower System Trim Kit 1.5 gpm/5.7 Lpm with 36-Inch Slide-Grab Bar and Hand Shower</p> <ul style="list-style-type: none"> • For Flash® shower rough-in valves with choice of connections (sold separately) • Includes 3-function hand shower with pause feature • Pause Feature: Non-positive shut-off button on handle reduces flow to a trickle to meet ADA requirement • 36" slide-grab bar meets the ANSI standard 250 lb pull test for grab bars • Metal wall escutcheon with metal lever handle. Red/blue indicator ring • 1.5 gpf/5.7 Lpm maximum flow rate 	<p>TU662SG211.002</p>	<p>Polished Chrome</p>	<p>397</p>

	<p>Commercial Shower System Trim Kit 1.5 gpm/5.7 Lpm with 36-Inch Slide-Grab Bar, Hand Shower and Showerhead</p> <ul style="list-style-type: none"> • For Flash® shower rough-in valves with choice of connections (sold separately) • 2-way rough diverter valve (R422 - sold separately) • Includes 3-function hand shower with pause feature • Pause Feature: Non-positive shut-off button on handle reduces flow to a trickle to meet ADA requirement • 2-way diverter valve trim kit • Fixed showerhead with arm and flange • 36" slide-grab bar meets the ANSI standard 250 lb pull test for grab bars • Metal wall escutcheon with metal lever handle. Red/blue indicator ring • 1.5 gpf/5.7 Lpm maximum flow rate 	<p>TU662SG213.002</p>	<p>Polished Chrome</p>	<p>512</p>
--	---	-----------------------	------------------------	------------











Commercial Fittings

Commercial Shower System Components

	Description	SKU	Color/Finish	List Price
	<p>Commercial 36-Inch Slide-Grab Bar</p> <ul style="list-style-type: none"> • 36" (914 mm) long combination slide bar and grab bar • Meets the ANSI standard 250 lb pull test for grab bars • 1-1/2" (38 mm) diameter stainless steel bar with chrome-plated hand shower holder • ADA-compliant lever handle to adjust hand shower height 	1662236.002	Polished Chrome	193
	<p>Institutional 1.5 gpm/5.7 Lpf Showerhead</p> <ul style="list-style-type: none"> • Solid brass construction for durability and long life • Vandal-resistant mounting • Pressure-compensating fl w control device • 1.5 gpm/5.7 Lpm maximum flow rate 	 1660244.002	Polished Chrome	166 
	<p>2.5 gpm/9.5 Lpf 3-Function Hand Shower With Pause Feature</p> <ul style="list-style-type: none"> • Pause Feature: Non-positive shut-off button on handle reduces flow to a trickle to meet ADA requirement • Pressure-compensating fl w control device • Easy Clean Spray Nozzles: Allows for easy cleaning of lime and calcium build up • Includes check valve • 2.5 gpm/9.5 Lpm maximum flow rate 	 1660767.002	Polished Chrome	65 
	<p>1.5 gpm/5.7 Lpf 3-Function Hand Shower With Pause Feature</p> <ul style="list-style-type: none"> • Pause Feature: Non-positive shut-off button on handle reduces flow to a trickle to meet ADA requirement • Pressure-compensating fl w control device • Easy Clean Spray Nozzles: Allows for easy cleaning of lime and calcium build up • Includes check valve • 1.5 gpm/5.7 Lpm maximum flow rate 	  1660766.002	Polished Chrome	65 
	<p>Heritage™ Metal Lever Handle Trim Kit for Diverter Valves</p> <ul style="list-style-type: none"> • For use with R422 (2-way) & R433 (3-way) rough diverter valves • Metal construction 	 T342430.002	Polished Chrome	109

Commercial Fittings



Commercial Service Sink Faucets

	Description	ADA	SKU	Color/Finish	List Price
	Wall-Mount Service Sink Faucet With 3-Inch Spout <ul style="list-style-type: none"> • 3" (76 mm) spout • Washerless ceramic disc valves assure drip-free performance • Vandal-resistant metal lever handles • 8" (203 mm) centers • Integral supply stops • 3/4" (19 mm) threaded hose end with bucket hook 		8350235.002	Polished Chrome	266
			8350235.004	Rough Chrome	217
	Wall-Mount Service Sink Faucet With 3-Inch Vacuum Breaker Spout <ul style="list-style-type: none"> • 3" (76 mm) vacuum breaker spout prevents back flow • Washerless ceramic disc valves assure drip-free performance • Vandal-resistant metal lever handles • 8" (203 mm) centers • Integral supply stops • 3/4" (19 mm) threaded hose end with bucket hook 		8350243.002	Polished Chrome	298
			8350243.004	Rough Chrome	246
	Wall-Mount Service Sink Faucet With 3-Inch Vacuum Breaker Spout and Offset Shanks <ul style="list-style-type: none"> • 3" (76 mm) vacuum breaker spout prevents back flow. • Washerless ceramic disc valves assure drip-free performance • Vandal-resistant metal lever handles • Offset shanks with adjustable rough-in from 6" - 10" (152 - 254 mm) centers • Integral check valves to prevent cross flow • Integral supply stops • 3/4" (19 mm) threaded hose end with bucket hook 		8351076.002	Polished Chrome	381
			8351076.004	Rough Chrome	321
	Bottom Brace Wall-Mount Service Sink Faucet With 12-Inch Spout and Offset Shanks <ul style="list-style-type: none"> • Bottom fork brace provides additional support • 12" (305 mm) spout • Washerless ceramic disc valves assure drip-free performance • Vandal-resistant metal wrist blade handles • Offset shanks with adjustable rough-in from 6" - 10" (152 - 254 mm) centers • Integral check valves to prevent cross flow • Integral supply stops • Plain end with bucket hook 		8345115.002	Polished Chrome	545
	Bottom Brace Wall-Mount Service Sink Faucet With 8-Inch Spout and Offset Shanks <ul style="list-style-type: none"> • Bottom fork brace provides additional support • 8" (203 mm) spout • Washerless ceramic disc valves assure drip-free performance • Vandal-resistant metal wrist blade handles • Offset shanks with adjustable rough-in from 6" - 10" (152 - 254 mm) centers • Integral check valves to prevent cross flow • Integral supply stops • Plain end with bucket hook 		8355101.002	Polished Chrome	478

Commercial Fittings

Commercial Service Sink Faucets

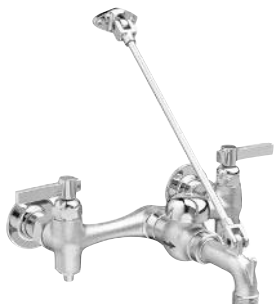
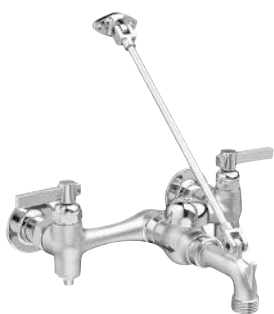
Service Sink Faucets

	Description	SKU	Color/Finish	List Price
	<p>Bottom Brace Wall-Mount Service Sink Faucet With 8-Inch Vacuum Breaker Spout and Offset Shanks</p> <ul style="list-style-type: none"> • Bottom fork brace provides additional support • 8" (203 mm) vacuum breaker spout prevents back flow • Washerless ceramic disc valves assure drip-free performance • Vandal-resistant metal lever handles • Offset shanks with adjustable 6-10" (152-254 mm) centers • Integral supply stops • Threaded hose end with bucket hook • Check valves prevent cross flow • 5-Year Limited Warranty for commercial installations 	<p>ADA 8355110.002</p>	<p>Polished Chrome</p>	<p>530</p> <p>MAP</p>
	<p>Top Brace Wall-Mount Service Sink Faucet with 6-Inch Vacuum Breaker Spout</p> <ul style="list-style-type: none"> • Top brace for additional support for bucket • 6" (152 mm) vacuum breaker spout prevents back flow • Washerless ceramic disc valves assure drip-free performance • Vandal-resistant metal lever handles • 8" (203 mm) centers • Integral supply stops • 3/4" (19 mm) threaded hose end with bucket hook 	<p>8344212.004</p>	<p>Rough Chrome</p>	<p>184</p> <p>MAP</p>
	<p>Top Brace Wall-Mount Service Sink Faucet with 6-Inch Vacuum Breaker Spout</p> <ul style="list-style-type: none"> • Top brace for additional support for bucket • 6" (152 mm) vacuum breaker spout prevents back flow • Washerless ceramic disc valves assure drip-free performance • Vandal-resistant metal lever handles • 8" (203 mm) centers • Integral supply stops • 3/4" (19 mm) threaded hose end with bucket hook 	<p>8344012.002</p>	<p>Polished Chrome</p>	<p>315</p> <p>MAP</p>
	<p>Top Brace Wall-Mount Service Sink Faucet With 6-Inch Vacuum Breaker Spout and Offset Shanks</p> <ul style="list-style-type: none"> • Top brace for additional support for bucket • 6" (152 mm) vacuum breaker spout prevents back flow • Washerless ceramic disc valves assure drip-free performance • Vandal-resistant metal lever handles • Offset shanks with adjustable rough-in from 6" - 10" (152 - 254 mm) centers • Integral check valves to prevent cross flow • Integral supply stops • 3/4" (19 mm) threaded hose end with bucket hook 	<p>ADA 8354112.002 8354112.004</p>	<p>Polished Chrome Rough Chrome</p>	<p>453 382</p> <p>MAP</p>

Commercial Fittings

Commercial and Institutional Fittings

Description	SKU	Color/Finish	List Price
-------------	-----	--------------	------------

Bedpan Cleanser With Atmospheric Vacuum Breaker and Loose Key Stop

7582167.002

Polished Chrome

626



- Loose key stop valve with 3/8" female NPT inlet
- Volume regulator with ceramic disc valve and wheel handle
- Atmospheric vacuum breaker
- Spray end
- 45-5/8" (1160 mm) rubber hose
- Wall hook



Institutional Fittings

Bedpan Cleanser With Self-Closing Valve and Hook

7866115.002

Polished Chrome

427



- Self-closing valve with spray end
- Wall nozzle with hook - 1/2" (13 mm) female NPT Inlet
- 45-5/8" (1160 mm) rubber hose
- To be used with valve stop (NOT FURNISHED)





Commercial Fittings

Ultima® Selectronic® Exposed Toilet Flush Valve – Diaphragm-Type Battery Powered



- For flushometer bowls with 1-½" (38 mm) exposed top spud
- Includes CR-P2 lithium battery with 4 year life (assuming 4,000 uses per month)
- Automatic touchless operation limits the spread of germs for a safer restroom
- Exclusive DynaClean® self-cleaning wiper spring technology
- Integral wiper spring cleans refill orifice with every flush to help prevent valve run-on
- EvoLast® premium chlorine- and chloramine-resistant diaphragm material resists premature deterioration and failure
- Fully mechanical manual override button can flush the valve without power
- Proprietary brass alloy resists dezincification
- Detection range can be adjusted manually or with optional remote control
- Adjustable tailpiece for rough-in flexibility. Can be installed left- or right-handed





Description	SKU	Color	List Price
Ultima® Selectronic® Exposed Toilet Flush Valve, Diaphragm Type, Battery, 1.6 gpf/6.0 Lpf	6247161.002	Polished Chrome	582
 Ultima® Selectronic® Exposed Toilet Flush Valve, Diaphragm Type, Battery, 1.1 gpf/4.2 Lpf	6247111.002	Polished Chrome	582
 Ultima® Selectronic® Exposed Toilet Flush Valve, Diaphragm Type, Battery, 1.28 gpf/4.8 Lpf	6247121.002	Polished Chrome	582
 Ultima® Selectronic® Exposed Toilet Flush Valve, Diaphragm Type, Battery, Dual Flush 1.28/1.1 gpf (4.8/4.2 Lpf)	6247721.002	Polished Chrome	582

Ultima® Selectronic® Exposed Urinal Flush Valve – Diaphragm-Type Battery Powered



- For urinals with ¾" (19 mm) exposed top spud
- Includes CR-P2 lithium battery with 4 year life (assuming 4,000 uses per month)
- Automatic touchless operation limits the spread of germs for a safer restroom
- Exclusive DynaClean® self-cleaning wiper spring technology
- Integral wiper spring cleans refill orifice with every flush to help prevent valve run-on
- EvoLast® premium chlorine- and chloramine-resistant diaphragm material resists premature deterioration and failure
- Fully mechanical manual override button can flush the valve without power
- Proprietary brass alloy resists dezincification
- Detection range can be adjusted manually or with optional remote control
- Adjustable tailpiece for rough-in flexibility. Can be installed left- or right-handed



Description	SKU	Color	List Price
Ultima® Selectronic® Exposed Urinal Flush Valve, Diaphragm Type, Battery, 1.0 gpf/3.8 Lpf	6245101.002	Polished Chrome	582
 Ultima® Selectronic® Exposed Urinal Flush Valve, Diaphragm Type, Battery, 0.125 gpf/0.5 Lpf	6245013.002	Polished Chrome	582
 Ultima® Selectronic® Exposed Urinal Flush Valve, Diaphragm Type, Battery, 0.5 gpf/1.9 Lpf	6245051.002	Polished Chrome	582

Flush Valves

Commercial Fittings

Ultima® Selectronic® Exposed Toilet Flush Valve – Diaphragm-Type Base Model for AC Power



- POWER KIT MUST BE PURCHASED SEPARATELY
- For flushometer bowls with 1-½" (38 mm) exposed top spud
- Automatic touchless operation limits the spread of germs for a safer restroom
- Exclusive DynaClean® self-cleaning wiper spring technology
- Integral wiper spring cleans refill orifice with every flush to help prevent valve run-on
- EvoLast® premium chlorine- and chloramine-resistant diaphragm material resists premature deterioration and failure
- Fully mechanical manual override button can flush the valve without power
- Proprietary brass alloy resists dezincification
- Detection range can be adjusted manually or with optional remote control
- Adjustable tailpiece for rough-in flexibility. Can be installed left- or right-handed



Description	SKU	Color	List Price
Ultima® Selectronic® Exposed Toilet Flush Valve, Diaphragm Type, Base Model, 1.6 gpf/6.0 Lpf	624B161.002	Polished Chrome	642
Ultima® Selectronic® Exposed Toilet Flush Valve, Diaphragm Type, Base Model, 1.1 gpf/4.2 Lpf	624B111.002	Polished Chrome	642
Ultima® Selectronic® Exposed Toilet Flush Valve, Diaphragm Type, Base Model, 1.28 gpf/4.8 Lpf	624B121.002	Polished Chrome	642
Ultima® Selectronic® Exposed Toilet Flush Valve, Diaphragm Type, Base Model, Dual Flush 1.28/1.1 gpf (4.8/4.2 Lpf)	624B721.002	Polished Chrome	642



Required Components:

Selectronic® Hard Wired AC Power Kit	PK00.HAC	No Finish	129
Selectronic® Multi-AC Power Kit	PK00.MAC	No Finish	72
Selectronic® Plug-In AC Power Kit	PK00.PAC	No Finish	94

Optional Components:

Selectronic® Battery Back-Up Kit	PK00.BBU	No Finish	88
----------------------------------	----------	-----------	----

Ultima® Selectronic® Exposed Urinal Flush Valve – Diaphragm-Type Base Model for AC Power



- POWER KIT MUST BE PURCHASED SEPARATELY
- For urinals with ¾" (19 mm) exposed top spud
- Automatic touchless operation limits the spread of germs for a safer restroom
- Exclusive DynaClean® self-cleaning wiper spring technology
- Integral wiper spring cleans refill orifice with every flush to help prevent valve run-on
- EvoLast® premium chlorine- and chloramine-resistant diaphragm material resists premature deterioration and failure
- Fully mechanical manual override button can flush the valve without power
- Proprietary brass alloy resists dezincification
- Detection range can be adjusted manually or with optional remote control
- Adjustable tailpiece for rough-in flexibility. Can be installed left- or right-handed



Description	SKU	Color	List Price
Ultima® Selectronic® Exposed Urinal Flush Valve, Diaphragm Type, Base Model, 1.0 gpf/3.8 Lpf	624B101.002	Polished Chrome	642
Ultima® Selectronic® Exposed Urinal Flush Valve, Diaphragm Type, Base Model, 0.125 gpf/0.5 Lpf	624B013.002	Polished Chrome	642
Ultima® Selectronic® Exposed Urinal Flush Valve, Diaphragm Type, Base Model, 0.5 gpf/1.9 Lpf	624B051.002	Polished Chrome	642



Required Components:

Selectronic® Hard Wired AC Power Kit	PK00.HAC	No Finish	129
Selectronic® Multi-AC Power Kit	PK00.MAC	No Finish	72
Selectronic® Plug-In AC Power Kit	PK00.PAC	No Finish	94

Optional Components:

Selectronic® Battery Back-Up Kit	PK00.BBU	No Finish	88
----------------------------------	----------	-----------	----

Selectronic® Power Kit



Commercial Fittings

Ultima® Sensor-Operated Toilet Flush Valve – Diaphragm-Type Battery Powered



- For flushometer bowls with 1-1/2" (38 mm) exposed top spud
- Includes 4 C-sized alkaline batteries
- Touchless operation limits the spread of germs
- Exclusive DynaClean® self-cleaning wiper spring technology
- Integral wiper spring cleans refill orifice with every flush to help prevent valve run-on
- EvoLast® premium chlorine- and chloramine-resistant diaphragm material resists premature deterioration and failure
- Electronically operated override button
- Proprietary brass alloy resists dezincification
- 11-1/2" (292 mm) rough-in



Description	SKU	Color	List Price
Ultima™ Touchless Sensor Toilet Flush Valve, Diaphragm-Type, 1.6 gpf/6.0 Lpf, 27-inch Rough-In	6147SM161.002	Polished Chrome	498
 Ultima™ Touchless Sensor Toilet Flush Valve, Diaphragm-Type, 1.1 gpf/4.2 Lpf	6147SM111.002	Polished Chrome	498
 Ultima™ Touchless Sensor Toilet Flush Valve, Diaphragm-Type, 1.28 gpf/4.8 Lpf	6147SM121.002	Polished Chrome	498

Separate Components:

Sensor-Operated Side-Mount Retrofit for Diaphragm Flush Valve's	SMGODIA.002	Polished Chrome	335
---	-------------	-----------------	-----

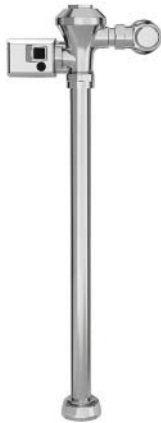

- For flushometer bowls with 1-1/2-inch (38 mm) exposed top spud
- Includes 4 C-sized alkaline batteries
- Touchless operation limits the spread of germs
- Exclusive DynaClean™ self-cleaning wiper spring technology
- Integral wiper spring cleans refill orifice with every flush to help prevent valve run-on
- EvoLast™ premium chlorine- and chloramine-resistant diaphragm material resists premature deterioration and failure
- Electronically operated override button
- Proprietary brass alloy resists dezincification
- 27-inch rough-in. Pipe can be cut during installation.



Description	SKU	Color	List Price
Ultima™ Touchless Sensor Toilet Flush Valve, Diaphragm-Type, 1.6 gpf/6.0 Lpf, 27-Inch (686 mm) Rough-In	6147SM162.002	Polished Chrome	515
 Ultima™ Touchless Sensor Toilet Flush Valve, Diaphragm-Type, 1.28 gpf/4.8 Lpf, 27-Inch Rough-In	6147SM122.002	Polished Chrome	515

Separate Components:

Sensor-Operated Side-Mount Retrofit for Diaphragm Flush Valve's	SMGODIA.002	Polished Chrome	335
---	-------------	-----------------	-----

Commercial Fittings

Ultima® Sensor-Operated Exposed Clinic Sink Flush Valve – Diaphragm-Type Battery Powered



- For clinic sinks with 1-½" (38 mm) exposed top spud
- Includes 4 C-sized alkaline batteries
- Touchless operation limits the spread of germs
- Exclusive DynaClean® self-cleaning wiper spring technology
- Integral wiper spring cleans refill orifice with every flush to help prevent valve run-on
- EvoLast® premium chlorine- and chloramine-resistant diaphragm material resists premature deterioration and failure
- Electronically operated override button
- Proprietary brass alloy resists dezincification
- 24" (610 mm) rough-in. Pipe can be cut during installation.
- 6.5 gpf/24.6 Lpf



Description	SKU	Color	List Price
Ultima™ Touchless Sensor Clinic Sink Flush Valve, Diaphragm-Type, 6.5 gpf/24.6 Lpf, 24-Inch Rough-In	6147SM117.002	Polished Chrome	565

Separate Components:

Sensor-Operated Side-Mount Retrofit for Diaphragm Flush Valve's	SMGODIA.002	Polished Chrome	335
---	-------------	-----------------	-----

Ultima® Sensor-Operated Exposed Urinal Flush Valve – Diaphragm-Type Battery Powered



- For urinals with ¾" (19 mm) exposed top spud
- Includes 4 C-sized alkaline batteries
- Touchless operation limits the spread of germs
- Exclusive DynaClean® self-cleaning wiper spring technology
- Integral wiper spring cleans refill orifice with every flush to help prevent valve run-on
- EvoLast® premium chlorine- and chloramine-resistant diaphragm material resists premature deterioration and failure
- Electronically operated override button
- Proprietary brass alloy resists dezincification
- 11-½" (292 mm) rough-in



Description	SKU	Color	List Price
Ultima™ Touchless Sensor Urinal Flush Valve, Diaphragm-Type, 1.0 gpf/3.8 Lpf	6145SM101.002	Polished Chrome	498
Ultima™ Touchless Sensor Urinal Flush Valve, Diaphragm-Type, 0.125 gpf/0.5 Lpf	6145SM013.002	Polished Chrome	498
Ultima™ Touchless Sensor Urinal Flush Valve, Diaphragm-Type, 0.5 gpf/1.9 Lpf	6145SM051.002	Polished Chrome	498



Separate Components:

Sensor-Operated Side-Mount Retrofit for Diaphragm Flush Valve's	SMGODIA.002	Polished Chrome	335
---	-------------	-----------------	-----

Commercial Fittings

Ultima® Manual Exposed Toilet Flush Valve – Diaphragm-Type



- For flushometer bowls with 1-½-inch (38 mm) exposed top spud
- Exclusive DynaClean® self-cleaning wiper spring technology
- Integral wiper spring cleans refill orifice with every flush to help prevent valve run-on
- EvoLast® premium chlorine- and chloramine-resistant diaphragm material resists premature deterioration and failure
- ADA-compliant non-hold open handle provides automatic shut-off after every flush
- Proprietary brass alloy resists dezincification
- High back pressure vacuum breaker helps prevent dripping
- Can be install left- or right-handed
- 11-½" (292 mm) rough-in



Description	SKU	Color	List Price
Ultima™ Manual Toilet Flush Valve, Diaphragm-Type, 1.6 gpf/6.0 Lpf	6147161.002	Polished Chrome	216
Ultima™ Manual Toilet Flush Valve, Diaphragm-Type, 1.1 gpf/4.2 Lpf	6147111.002	Polished Chrome	216
Ultima Manual Toilet Flush Valve, Diaphragm-Type, 1.28 gpf/4.8 Lpf	6147121.002	Polished Chrome	216

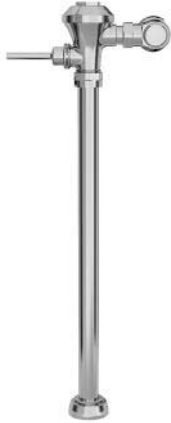

- For flushometer bowls with 1-½-inch (38 mm) exposed top spud
- Exclusive DynaClean® self-cleaning wiper spring technology
- Integral wiper spring cleans refill orifice with every flush to help prevent valve run-on
- EvoLast® premium chlorine- and chloramine-resistant diaphragm material resists premature deterioration and failure
- ADA-compliant non-hold open handle provides automatic shut-off after every flush
- Proprietary brass alloy resists dezincification
- High back pressure vacuum breaker helps prevent dripping
- Can be install left- or right-handed
- 27" (686 mm) rough-in. Pipe can be cut during installation.



Description	SKU	Color	List Price
Ultima™ Manual Toilet Flush Valve, Diaphragm-Type, 1.6 gpf/6.0 Lpf, 27-Inch Rough-In	6147162.002	Polished Chrome	235
Ultima™ Manual Toilet Flush Valve, Diaphragm-Type, 1.28 gpf/4.8 Lpf, 27-Inch Rough-In	6147122.002	Polished Chrome	235

Flush Valves

Commercial Fittings

Ultima® Manual Exposed Clinic Sink Flush Valve – Diaphragm-Type

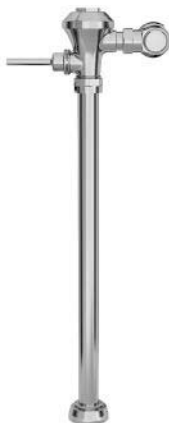

- For clinic sink with 1-½-inch (38 mm) exposed top spud
- Exclusive DynaClean® self-cleaning wiper spring technology
- Integral wiper spring cleans refill orifice with every flush to help prevent valve run-on
- EvoLast® premium chlorine- and chloramine-resistant diaphragm material resists premature deterioration and failure
- ADA-compliant non-hold open handle provides automatic shut-off after every flush
- Proprietary brass alloy resists dezincification
- High back pressure vacuum breaker helps prevent dripping
- Can be install left- or right-handed
- 24" (610 mm) rough-in. Pipe can be cut during installation.
- 6.5 gpf/24.6 Lpf





Description	SKU	Color	List Price
Ultima™ Manual Clinic Sink Flush Valve, Diaphragm-Type, 6.5 gpf/24.6 Lpf, 24-Inch Rough-In	6147117.002	Polished Chrome	232

Ultima® Manual Exposed Urinal Flush Valve – Diaphragm-Type



- For urinals with ¾-inch (19 mm) exposed top spud
- Exclusive DynaClean® self-cleaning wiper spring technology
- Integral wiper spring cleans refill orifice with every flush to help prevent valve run-on
- EvoLast® premium chlorine- and chloramine-resistant diaphragm material resists premature deterioration and failure
- ADA-compliant non-hold open handle provides automatic shut-off after every flush
- Proprietary brass alloy resists dezincification
- High back pressure vacuum breaker helps prevent dripping
- Can be install left- or right-handed
- 11-½" (292 mm) rough-in



Description	SKU	Color	List Price
Ultima™ Manual Urinal Flush Valve, Diaphragm-Type, 1.0 gpf/3.8 Lpf	6145101.002	Polished Chrome	216
 Ultima™ Manual Urinal Flush Valve, Diaphragm-Type, 0.125 gpf/0.5 Lpf	6145013.002	Polished Chrome	216
 Ultima™ Manual Urinal Flush Valve, Diaphragm-Type, 0.5 gpf/1.9 Lpf	6145051.002	Polished Chrome	216



Commercial Fittings

Ultima® Selectronic® Exposed Toilet Flush Valve – Piston-Type PWRX® 10-Year Battery System



- For flushometer bowls with 1-½-inch (38 mm) exposed top spud
- 10-Year PWRX® Battery installed in valve
- Touchless operation limits the spread of germs
- Exclusive DynaClean® self-cleaning wiper spring technology
- Integral wiper spring cleans refill orifice with every flush to help prevent valve run-on
- Fully mechanical manual override can operate without power
- Fail-Safe operation: Valve automatically closes upon loss of power or water pressure
- Proprietary brass alloy resists dezincification
- 11-½" (292 mm) rough-in





Description	SKU	Color	List Price
Ultima™ Selectronic Touchless Toilet Flush Valve, Piston-Type, PWRX, 1.6 gpf/6.0 Lpf	6066161.002	Polished Chrome	690
 Ultima™ Selectronic Touchless Toilet Flush Valve, Piston-Type, PWRX, 1.1 gpf/4.2 Lpf	6066111.002	Polished Chrome	690
 Ultima™ Selectronic Touchless Toilet Flush Valve, Piston-Type, PWRX, 1.28 gpf/4.8 Lpf	6066121.002	Polished Chrome	690
 Ultima™ Selectronic Touchless Toilet Flush Valve, Piston-Type, PWRX, Dual Flush 1.28/1.1 gpf (4.8/4.2 Lpf)	6066721.002	Polished Chrome	690
Ultima™ Selectronic Touchless Toilet Flush Valve, Piston-Type, PWRX, Dual Flush 1.6/ 1.1 gpf (6.0/4.2 Lpf)	6066761.002	Polished Chrome	690

Ultima® Selectronic® Exposed Urinal Flush Valve – Piston-Type PWRX® 10-Year Battery System



- For urinals with ¾-inch (19 mm) exposed top spud
- 10-Year PWRX® Battery installed in valve
- Touchless operation limits the spread of germs
- Exclusive DynaClean® self-cleaning wiper spring technology
- Integral wiper spring cleans refill orifice with every flush to help prevent valve run-on
- Fully mechanical manual override can operate without power
- Fail-Safe operation: Valve automatically closes upon loss of power or water pressure
- Pressure Compensation feature ensures accurate flush volume regardless of inlet water pressure
- Proprietary brass alloy resists dezincification
- 11-½" (292 mm) rough-in



Description	SKU	Color	List Price
Ultima™ Selectronic Touchless Urinal Flush Valve, Piston-Type, PWRX, 1.0 gpf/3.8 Lpf	6064101.002	Polished Chrome	661
 Ultima™ Selectronic Touchless Urinal Flush Valve, Piston-Type, PWRX, 0.125 gpf/0.5 Lpf	6064013.002	Polished Chrome	661
 Ultima™ Selectronic Touchless Urinal Flush Valve, Piston-Type, PWRX, 0.5 gpf/1.9 Lpf	6064051.002	Polished Chrome	661

Flush Valves

Flush valve accessories



Commercial Fittings

Ultima® Selectronic® Exposed Toilet Flush Valve – Piston-Type Battery Powered



- For flushometer bowls with 1-½-inch (38 mm) exposed top spud
- Includes CR-P2 lithium battery with 8 year life (assuming 4,000 uses per month)
- Touchless operation limits the spread of germs
- Exclusive DynaClean® self-cleaning wiper spring technology
- Integral wiper spring cleans refill orifice with every flush to help prevent valve run-on
- Fully mechanical manual override can operate without power
- Fail-Safe operation: Valve automatically closes upon loss of power or water pressure
- Proprietary brass alloy resists dezincification
- 11-½" (292 mm) rough-in



Description	SKU	Color	List Price
Ultima™ Selectronic Touchless Toilet Flush Valve, Piston-Type, Battery, 1.6 gpf/6.0 Lpf	6065161.002	Polished Chrome	582
	6065161.295	Brushed Nickel	
 Ultima™ Selectronic Touchless Toilet Flush Valve, Piston-Type, Battery, 1.1 gpf/4.2 Lpf	6065111.002	Polished Chrome	582
 Ultima™ Selectronic Touchless Toilet Flush Valve, Piston-Type, Battery, 1.28 gpf/4.8 Lpf	6065121.002	Polished Chrome	582
 Ultima™ Selectronic Touchless Toilet Flush Valve, Piston-Type, Battery, Dual Flush 1.28/1.1 gpf (4.8/4.2 Lpf)	6065721.002	Polished Chrome	582
Ultima™ Selectronic Touchless Toilet Flush Valve, Piston-Type, Battery, Dual Flush 1.6/ 1.1 gpf (6.0/4.2 Lpf)	6065761.002	Polished Chrome	582



Commercial Fittings

Ultima® Selectronic® Exposed Urinal Flush Valve – Piston-Type Battery Powered



- For urinals with 3/4-inch (19 mm) exposed top spud
- Includes CR-P2 lithium battery with 4 year life (assuming 4,000 uses per month)
- Touchless operation limits the spread of germs
- Exclusive DynaClean® self-cleaning wiper spring technology
- Integral wiper spring cleans refill orifice with every flush to help prevent valve run-on
- Fully mechanical manual override can operate without power
- Fail-Safe operation: Valve automatically closes upon loss of power or water pressure
- Pressure Compensation feature ensures accurate flush volume regardless of inlet water pressure
- Proprietary brass alloy resists dezincification
- 11-1/2" (292 mm) rough-in



Description	SKU	Color	List Price
Ultima™ Selectronic Touchless Urinal Flush Valve, Piston-Type, Battery, 1.0 gpf/3.8 Lpf	6063101.002	Polished Chrome	582
	6063101.295	Brushed Nickel	
 Ultima™ Selectronic Touchless Urinal Flush Valve, Piston-Type, Battery, 0.125 gpf/0.5 Lpf	6063013.002	Polished Chrome	582
 Ultima™ Selectronic Touchless Urinal Flush Valve, Piston-Type, Battery, 0.5 gpf/1.9 Lpf	6063051.002	Polished Chrome	582



- For urinals with 1-1/4-inch (32 mm) exposed top spud
- Includes CR-P2 lithium battery with 4 year life (assuming 4,000 uses per month)
- Touchless operation limits the spread of germs
- Exclusive DynaClean® self-cleaning wiper spring technology
- Integral wiper spring cleans refill orifice with every flush to help prevent valve run-on
- Fully mechanical manual override can operate without power
- Fail-Safe operation: Valve automatically closes upon loss of power or water pressure
- Pressure Compensation feature ensures accurate flush volume regardless of inlet water pressure
- Proprietary brass alloy resists dezincification
- 11-1/2" (292 mm) rough-in



Description	SKU	Color	List Price
Ultima™ Selectronic Touchless Urinal Flush Valve, Piston-Type, Battery, 1.0 gpf/3.8 Lpf, 1-1/4-inch	6062601.002	Polished Chrome	633



Commercial Fittings

Ultima® Selectronic® Exposed Toilet Flush Valve – Piston-Type Base Model for AC Power



- POWER KIT MUST BE PURCHASED SEPARATELY
- For flushometer bowls with 1-½-inch (38 mm) exposed top spud
- Touchless operation limits the spread of germs
- Exclusive DynaClean® self-cleaning wiper spring technology
- Integral wiper spring cleans refill orifice with every flush to help prevent valve run-on
- Fully mechanical manual override can operate without power
- Fail-Safe operation: Valve automatically closes upon loss of power or water pressure
- Proprietary brass alloy resists dezincification
- 11-½" (292 mm) rough-in



Description	SKU	Color	List Price
Ultima™ Selectronic Touchless Toilet Flush Valve, Piston-Type, Base Model, 1.6 gpf/6.0 Lpf	606B161.002	Polished Chrome	571
 Ultima™ Selectronic Touchless Toilet Flush Valve, Piston-Type, Base Model, 1.1 gpf/4.2 Lpf	606B111.002	Polished Chrome	547
 Ultima™ Selectronic Touchless Toilet Flush Valve, Piston-Type, Base Model, 1.28 gpf/4.8 Lpf	606B121.002	Polished Chrome	547
 Ultima™ Selectronic Touchless Toilet Piston Flush Valve, Base Model, Dual Flush 1.28/1.1 gpf (4.8/4.2 Lpf)	606B721.002	Polished Chrome	571
Ultima™ Selectronic Touchless Toilet Piston Flush Valve, Base Model, Dual Flush 1.6/ 1.1 gpf (6.0/4.2 Lpf)	606B761.002	Polished Chrome	571
Required Components:			
Selectronic® Hard Wired AC Power Kit	PK00.HAC	No Finish	129
Selectronic® Multi-AC Power Kit	PK00.MAC	No Finish	72
Selectronic® Plug-In AC Power Kit	PK00.PAC	No Finish	94
Optional Components:			
Selectronic® Battery Back-Up Kit	PK00.BBU	No Finish	88

Commercial Fittings

Ultima® Selectronic® Exposed Urinal Flush Valve – Piston-Type Base Model for AC Power



- POWER KIT MUST BE PURCHASED SEPARATELY
- For urinals with 3/4-inch (19 mm) exposed top spud
- Touchless operation limits the spread of germs
- Exclusive DynaClean® self-cleaning wiper spring technology
- Integral wiper spring cleans refill orifice with every flush to help prevent valve run-on
- Fully mechanical manual override can operate without power
- Fail-Safe operation: Valve automatically closes upon loss of power or water pressure
- Pressure Compensation feature ensures accurate flush volume regardless of inlet water pressure
- Proprietary brass alloy resists dezincification
- 11-1/2" (292 mm) rough-in



Description	SKU	Color	List Price
Ultima™ Selectronic Touchless Urinal Flush Valve, Piston-Type, Base Model, 1.0 gpf/3.8 Lpf	606B101.002	Polished Chrome	547
Ultima™ Selectronic Touchless Urinal Flush Valve, Piston-Type, Base Model, 0.125 gpf/0.5 Lpf	606B013.002	Polished Chrome	547
Ultima™ Selectronic Touchless Urinal Flush Valve, Piston-Type, Base Model, 0.5 gpf/1.9 Lpf	606B051.002	Polished Chrome	547

Required Components:

Selectronic® Hard Wired AC Power Kit	PK00.HAC	No Finish	129
Selectronic® Multi-AC Power Kit	PK00.MAC	No Finish	72
Selectronic® Plug-In AC Power Kit	PK00.PAC	No Finish	94

Optional Components:

Selectronic® Battery Back-Up Kit	PK00.BBU	No Finish	88
----------------------------------	----------	-----------	----

Commercial Fittings

Ultima® Selectronic® Concealed Toilet Flush Valves – Piston-Type Rear Access, 1.6 gpf/6.0 Lpf



- For flushometer bowls with 1-1/2" (38 mm) exposed back spud
- POWER KIT MUST BE PURCHASED SEPARATELY
- FOR INSTALLATIONS WITH REAR ACCESS
- Includes 6" x 6" (152 x 152 mm) chrome cover plate
- Touchless operation limits the spread of germs
- Exclusive DynaClean® self-cleaning wiper spring technology
- Integral wiper spring cleans refill orifice with every flush to help prevent valve run-on
- Fully mechanical manual override can operate without power
- Proprietary brass alloy resists dezincification
- 1.6 gpf/6.0 Lpf



Description	SKU	Color	List Price
Ultima™ Selectronic Concealed Toilet Flush Valve, Base Model, Piston-Type, 1.6 gpf/6.0 Lpf	606B261.007	No Finish	724

Required Components:

Selectronic® CR-P2 Lithium Power Kit	PK00.CRP	No Finish	42
Selectronic® Hard Wired AC Power Kit	PK00.HAC	No Finish	129
Selectronic® Multi-AC Power Kit	PK00.MAC	No Finish	72
Selectronic® Plug-In AC Power Kit	PK00.PAC	No Finish	94
Selectronic® PWRX® Power Kit	PK00.WRK	No Finish	158

Optional Components:

Selectronic® Battery Back-Up Kit	PK00.BBU	No Finish	88
----------------------------------	----------	-----------	----



- For flushometer bowls with 1-1/2" (38 mm) back spud
- POWER KIT MUST BE PURCHASED SEPARATELY
- FOR INSTALLATIONS WITH REAR ACCESS
- Includes 6" x 6" (152 x 152 mm) chrome cover plate
- Touchless operation limits the spread of germs
- Exclusive DynaClean® self-cleaning wiper spring technology
- Integral wiper spring cleans refill orifice with every flush to help prevent valve run-on
- Fully mechanical manual override can operate without power
- Proprietary brass alloy resists dezincification
- 1.6 gpf/6.0 Lpf



Description	SKU	Color	List Price
Ultima™ Selectronic Concealed Toilet Flush Valve, Base Model, Piston-Type, 1.6 gpf/6.0 Lpf	606B262.007	No Finish	664

Required Components:

Selectronic® CR-P2 Lithium Power Kit	PK00.CRP	No Finish	42
Selectronic® Hard Wired AC Power Kit	PK00.HAC	No Finish	129
Selectronic® Multi-AC Power Kit	PK00.MAC	No Finish	72
Selectronic® Plug-In AC Power Kit	PK00.PAC	No Finish	94
Selectronic® PWRX® Power Kit	PK00.WRK	No Finish	158

Optional Components:

Selectronic® Battery Back-Up Kit	PK00.BBU	No Finish	88
----------------------------------	----------	-----------	----

Selectronic® Power Kit

Commercial Fittings

Ultima® Selectronic® Concealed Toilet Flush Valves With Wall Box – Piston-Type Front Access, 1.6 gpf/6.0 Lpf



- For flushometer bowls with 1-1/2" (38 mm) exposed back spud
- POWER KIT MUST BE PURCHASED SEPARATELY
- FOR INSTALLATIONS WITH FRONT ACCESS
- Includes Wall Box with Vandal-Resistant Brushed S.S. Cover
- Touchless operation limits the spread of germs
- Exclusive DynaClean® self-cleaning wiper spring technology
- Integral wiper spring cleans refill orifice with every flush to help prevent valve run-on
- Fully mechanical manual override can operate without power
- Proprietary brass alloy resists dezincification
- 1.6 gpf/6.0 Lpf



Description	SKU	Color	List Price
Ultima™ Selectronic Concealed Toilet Flush Valve with Wall Box, Base Model, Piston-Type, 1.6 gpf/6.0 Lpf	606B361.007	No Finish	1,105

Required Components:

Selectronic® CR-P2 Lithium Power Kit	PK00.CRP	No Finish	42
Selectronic® Hard Wired AC Power Kit	PK00.HAC	No Finish	129
Selectronic® Multi-AC Power Kit	PK00.MAC	No Finish	72
Selectronic® Plug-In AC Power Kit	PK00.PAC	No Finish	94
Selectronic® PWRX® Power Kit	PK00.WRK	No Finish	158

Optional Components:

Selectronic® Battery Back-Up Kit	PK00.BBU	No Finish	88
----------------------------------	----------	-----------	----



- For flushometer bowls with 1-1/2" (38 mm) back spud
- POWER KIT MUST BE PURCHASED SEPARATELY
- FOR INSTALLATIONS WITH FRONT ACCESS
- Includes Wall Box with Vandal-Resistant Brushed S.S. Cover
- Touchless operation limits the spread of germs
- Exclusive DynaClean® self-cleaning wiper spring technology
- Integral wiper spring cleans refill orifice with every flush to help prevent valve run-on
- Fully mechanical manual override can operate without power
- Proprietary brass alloy resists dezincification
- 1.6 gpf/6.0 Lpf



Description	SKU	Color	List Price
Ultima™ Selectronic Concealed Toilet Flush Valve with Wall Box, Base Model, Piston-Type, 1.6 gpf/6.0 Lpf	606B362.007	No Finish	1,041

Required Components:

Selectronic® CR-P2 Lithium Power Kit	PK00.CRP	No Finish	42
Selectronic® Hard Wired AC Power Kit	PK00.HAC	No Finish	129
Selectronic® Multi-AC Power Kit	PK00.MAC	No Finish	72
Selectronic® Plug-In AC Power Kit	PK00.PAC	No Finish	94
Selectronic® PWRX® Power Kit	PK00.WRK	No Finish	158

Optional Components:

Selectronic® Battery Back-Up Kit	PK00.BBU	No Finish	88
----------------------------------	----------	-----------	----

Selectronic® Power Kit

Commercial Fittings

Ultima® Selectronic® Concealed Toilet Flush Valves – Piston-Type Rear Access, 1.28 gpf/4.8 Lpf



- For flushometer bowls with 1-1/2" (38 mm) exposed back spud
- POWER KIT MUST BE PURCHASED SEPARATELY
- FOR INSTALLATIONS WITH REAR ACCESS
- Includes 6" x 6" (152 x 152 mm) chrome cover plate
- Touchless operation limits the spread of germs
- Exclusive DynaClean® self-cleaning wiper spring technology
- Integral wiper spring cleans refill orifice with every flush to help prevent valve run-on
- Fully mechanical manual override can operate without power
- Proprietary brass alloy resists dezincification
- 1.28 gpf/4.8 Lpf



Description	SKU	Color	List Price
Ultima™ Selectronic Concealed Toilet Flush Valve, Base Model, Piston-Type, 1.28 gpf/4.8 Lpf	606B221.007	No Finish	724

Required Components:

Selectronic® CR-P2 Lithium Power Kit	PK00.CRP	No Finish	42
Selectronic® Hard Wired AC Power Kit	PK00.HAC	No Finish	129
Selectronic® Multi-AC Power Kit	PK00.MAC	No Finish	72
Selectronic® Plug-In AC Power Kit	PK00.PAC	No Finish	94
Selectronic® PWRX® Power Kit	PK00.WRK	No Finish	158

Optional Components:

Selectronic® Battery Back-Up Kit	PK00.BBU	No Finish	88
----------------------------------	----------	-----------	----



- For flushometer bowls with 1-1/2" (38 mm) back spud
- POWER KIT MUST BE PURCHASED SEPARATELY
- FOR INSTALLATIONS WITH REAR ACCESS
- Includes 6" x 6" (152 x 152 mm) chrome cover plate
- Touchless operation limits the spread of germs
- Exclusive DynaClean® self-cleaning wiper spring technology
- Integral wiper spring cleans refill orifice with every flush to help prevent valve run-on
- Fully mechanical manual override can operate without power
- Proprietary brass alloy resists dezincification
- 1.28 gpf/4.8 Lpf



Description	SKU	Color	List Price
Ultima™ Selectronic Concealed Toilet Flush Valve, Base Model, Piston-Type, 1.28 gpf/4.8 Lpf	606B222.007	No Finish	664

Required Components:

Selectronic® CR-P2 Lithium Power Kit	PK00.CRP	No Finish	42
Selectronic® Hard Wired AC Power Kit	PK00.HAC	No Finish	129
Selectronic® Multi-AC Power Kit	PK00.MAC	No Finish	72
Selectronic® Plug-In AC Power Kit	PK00.PAC	No Finish	94
Selectronic® PWRX® Power Kit	PK00.WRK	No Finish	158

Optional Components:

Selectronic® Battery Back-Up Kit	PK00.BBU	No Finish	88
----------------------------------	----------	-----------	----

Selectronic® Power Kit

Commercial Fittings

Ultima® Selectronic® Concealed Toilet Flush Valves With Wall Box – Piston-Type Front Access, 1.28 gpf/4.8 Lpf



- For flushometer bowls with 1-1/2" (38 mm) exposed back spud
- POWER KIT MUST BE PURCHASED SEPARATELY
- FOR INSTALLATIONS WITH FRONT ACCESS
- Includes Wall Box with Vandal-Resistant Brushed S.S. Cover
- Touchless operation limits the spread of germs
- Exclusive DynaClean® self-cleaning wiper spring technology
- Integral wiper spring cleans refill orifice with every flush to help prevent valve run-on
- Fully mechanical manual override can operate without power
- Proprietary brass alloy resists dezincification
- 1.28 gpf/4.8 Lpf



Description	SKU	Color	List Price
Ultima™ Selectronic Concealed Toilet Flush Valve with Wall Box, Base Model, Piston-Type, 1.28 gpf/4.8 Lpf	606B321.007	No Finish	1,105

Required Components:

Selectronic® CR-P2 Lithium Power Kit	PK00.CRP	No Finish	42
Selectronic® Hard Wired AC Power Kit	PK00.HAC	No Finish	129
Selectronic® Multi-AC Power Kit	PK00.MAC	No Finish	72
Selectronic® Plug-In AC Power Kit	PK00.PAC	No Finish	94
Selectronic® PWRX® Power Kit	PK00.WRK	No Finish	158

Optional Components:

Selectronic® Battery Back-Up Kit	PK00.BBU	No Finish	88
----------------------------------	----------	-----------	----



- For flushometer bowls with 1-1/2" (38 mm) back spud
- POWER KIT MUST BE PURCHASED SEPARATELY
- FOR INSTALLATIONS WITH FRONT ACCESS
- Includes Wall Box with Vandal-Resistant Brushed S.S. Cover
- Touchless operation limits the spread of germs
- Exclusive DynaClean® self-cleaning wiper spring technology
- Integral wiper spring cleans refill orifice with every flush to help prevent valve run-on
- Fully mechanical manual override can operate without power
- Proprietary brass alloy resists dezincification
- 1.28 gpf/4.8 Lpf



Description	SKU	Color	List Price
Ultima™ Selectronic Concealed Toilet Flush Valve with Wall Box, Base Model, Piston-Type, 1.28 gpf/4.8 Lpf	606B322.007	No Finish	1,041

Required Components:

Selectronic® CR-P2 Lithium Power Kit	PK00.CRP	No Finish	42
Selectronic® Hard Wired AC Power Kit	PK00.HAC	No Finish	129
Selectronic® Multi-AC Power Kit	PK00.MAC	No Finish	72
Selectronic® Plug-In AC Power Kit	PK00.PAC	No Finish	94
Selectronic® PWRX® Power Kit	PK00.WRK	No Finish	158

Optional Components:

Selectronic® Battery Back-Up Kit	PK00.BBU	No Finish	88
----------------------------------	----------	-----------	----

Commercial Fittings

Ultima® Selectronic® Concealed Toilet Flush Valves – Piston-Type Rear Access, 1.1 gpf/4.2 Lpf



- For flushometer bowls with 1-1/2" (38 mm) exposed back spud
- POWER KIT MUST BE PURCHASED SEPARATELY
- FOR INSTALLATIONS WITH REAR ACCESS
- Includes 6" x 6" (152 x 152 mm) chrome cover plate
- Touchless operation limits the spread of germs
- Exclusive DynaClean® self-cleaning wiper spring technology
- Integral wiper spring cleans refill orifice with every flush to help prevent valve run-on
- Fully mechanical manual override can operate without power
- Proprietary brass alloy resists dezincification
- 1.1 gpf/4.2 Lpf



Description	SKU	Color	List Price
Ultima™ Selectronic Concealed Toilet Flush Valve, Base Model, Piston-Type, 1.1 gpf/4.2 Lpf	606B211.007	No Finish	724

Required Components:

Selectronic® CR-P2 Lithium Power Kit	PK00.CRP	No Finish	42
Selectronic® Hard Wired AC Power Kit	PK00.HAC	No Finish	129
Selectronic® Multi-AC Power Kit	PK00.MAC	No Finish	72
Selectronic® Plug-In AC Power Kit	PK00.PAC	No Finish	94
Selectronic® PWRX® Power Kit	PK00.WRK	No Finish	158

Optional Components:

Selectronic® Battery Back-Up Kit	PK00.BBU	No Finish	88
----------------------------------	----------	-----------	----



- For flushometer bowls with 1-1/2" (38 mm) back spud
- POWER KIT MUST BE PURCHASED SEPARATELY
- FOR INSTALLATIONS WITH REAR ACCESS
- Includes 6" x 6" (152 x 152 mm) chrome cover plate
- Touchless operation limits the spread of germs
- Exclusive DynaClean® self-cleaning wiper spring technology
- Integral wiper spring cleans refill orifice with every flush to help prevent valve run-on
- Fully mechanical manual override can operate without power
- Proprietary brass alloy resists dezincification
- 1.1 gpf/4.2 Lpf



Description	SKU	Color	List Price
Ultima™ Selectronic Concealed Toilet Flush Valve, Base Model, Piston-Type, 1.1 gpf/4.2 Lpf	606B212.007	No Finish	664

Required Components:

Selectronic® CR-P2 Lithium Power Kit	PK00.CRP	No Finish	42
Selectronic® Hard Wired AC Power Kit	PK00.HAC	No Finish	129
Selectronic® Multi-AC Power Kit	PK00.MAC	No Finish	72
Selectronic® Plug-In AC Power Kit	PK00.PAC	No Finish	94
Selectronic® PWRX® Power Kit	PK00.WRK	No Finish	158

Optional Components:

Selectronic® Battery Back-Up Kit	PK00.BBU	No Finish	88
----------------------------------	----------	-----------	----

Selectronic® Power Kit

Commercial Fittings

Ultima® Selectronic® Concealed Toilet Flush Valves With Wall Box – Piston-Type Front Access, 1.1 gpf/4.2 Lpf



- For flushometer bowls with 1-1/2" (38 mm) exposed back spud
- POWER KIT MUST BE PURCHASED SEPARATELY
- FOR INSTALLATIONS WITH FRONT ACCESS
- Includes Wall Box with Vandal-Resistant Brushed S.S. Cover
- Touchless operation limits the spread of germs
- Exclusive DynaClean® self-cleaning wiper spring technology
- Integral wiper spring cleans refill orifice with every flush to help prevent valve run-on
- Fully mechanical manual override can operate without power
- Proprietary brass alloy resists dezincification
- 1.1 gpf/4.2 Lpf



Description	SKU	Color	List Price
Ultima™ Selectronic Concealed Toilet Flush Valve with Wall Box, Base Model, Piston-Type, 1.1 gpf/4.2 Lpf	606B311.007	No Finish	1,105

Required Components:

Selectronic® CR-P2 Lithium Power Kit	PK00.CRP	No Finish	42
Selectronic® Hard Wired AC Power Kit	PK00.HAC	No Finish	129
Selectronic® Multi-AC Power Kit	PK00.MAC	No Finish	72
Selectronic® Plug-In AC Power Kit	PK00.PAC	No Finish	94
Selectronic® PWRX® Power Kit	PK00.WRK	No Finish	158

Optional Components:

Selectronic® Battery Back-Up Kit	PK00.BBU	No Finish	88
----------------------------------	----------	-----------	----



- For flushometer bowls with 1-1/2" (38 mm) back spud
- POWER KIT MUST BE PURCHASED SEPARATELY
- FOR INSTALLATIONS WITH FRONT ACCESS
- Includes Wall Box with Vandal-Resistant Brushed S.S. Cover
- Touchless operation limits the spread of germs
- Exclusive DynaClean® self-cleaning wiper spring technology
- Integral wiper spring cleans refill orifice with every flush to help prevent valve run-on
- Fully mechanical manual override can operate without power
- Proprietary brass alloy resists dezincification
- 1.1 gpf/4.2 Lpf



Description	SKU	Color	List Price
Ultima™ Selectronic Concealed Toilet Flush Valve with Wall Box, Base Model, Piston-Type, 1.1 gpf/4.2 Lpf	606B312.007	No Finish	1,041

Required Components:

Selectronic® CR-P2 Lithium Power Kit	PK00.CRP	No Finish	42
Selectronic® Hard Wired AC Power Kit	PK00.HAC	No Finish	129
Selectronic® Multi-AC Power Kit	PK00.MAC	No Finish	72
Selectronic® Plug-In AC Power Kit	PK00.PAC	No Finish	94
Selectronic® PWRX® Power Kit	PK00.WRK	No Finish	158

Optional Components:

Selectronic® Battery Back-Up Kit	PK00.BBU	No Finish	88
----------------------------------	----------	-----------	----

Flush Valves

Commercial Fittings

Ultima® Selectronic® Concealed Urinal Flush Valves – Piston-Type 1.0 gpf/3.8 Lpf



- For urinals with 3/4" (19 mm) back spud
- POWER KIT MUST BE PURCHASED SEPARATELY
- FOR INSTALLATIONS WITH REAR ACCESS
- Includes 6" x 6" (152 x 152 mm) chrome cover plate
- Touchless operation limits the spread of germs
- Exclusive DynaClean® self-cleaning wiper spring technology
- Integral wiper spring cleans refill orifice with every flush to help prevent valve run-on
- Fully mechanical manual override can operate without power
- Proprietary brass alloy resists dezincification
- 1.0 gpf/3.8 Lpf



Description	SKU	Color	List Price
Ultima™ Selectronic Concealed Urinal Flush Valve, Base Model, Piston-Type, 1.0 gpf/3.8 Lpf	606B310.007	No Finish	664

Required Components:

Selectronic® CR-P2 Lithium Power Kit	PK00.CRP	No Finish	42
Selectronic® Hard Wired AC Power Kit	PK00.HAC	No Finish	129
Selectronic® Multi-AC Power Kit	PK00.MAC	No Finish	72
Selectronic® Plug-In AC Power Kit	PK00.PAC	No Finish	94
Selectronic® PWRX® Power Kit	PK00.WRK	No Finish	158

Optional Components:

Selectronic® Battery Back-Up Kit	PK00.BBU	No Finish	88
----------------------------------	----------	-----------	----

Flush Valves



- For urinals with 3/4" (19 mm) back spud
- POWER KIT MUST BE PURCHASED SEPARATELY
- FOR INSTALLATIONS WITH FRONT ACCESS
- Includes Wall Box with Vandal-Resistant Brushed S.S. Cover
- Touchless operation limits the spread of germs
- Exclusive DynaClean® self-cleaning wiper spring technology
- Integral wiper spring cleans refill orifice with every flush to help prevent valve run-on
- Fully mechanical manual override can operate without power
- Proprietary brass alloy resists dezincification
- 1.0 gpf/3.8 Lpf



Description	SKU	Color	List Price
Ultima™ Selectronic Concealed Urinal Flush Valve with Wall Box, Base Model, Piston-Type, 1.0 gpf/3.8 Lpf	606B510.007	No Finish	1,041

Required Components:

Selectronic® CR-P2 Lithium Power Kit	PK00.CRP	No Finish	42
Selectronic® Hard Wired AC Power Kit	PK00.HAC	No Finish	129
Selectronic® Multi-AC Power Kit	PK00.MAC	No Finish	72
Selectronic® Plug-In AC Power Kit	PK00.PAC	No Finish	94
Selectronic® PWRX® Power Kit	PK00.WRK	No Finish	158

Optional Components:

Selectronic® Battery Back-Up Kit	PK00.BBU	No Finish	88
----------------------------------	----------	-----------	----

Selectronic® Power Kit

Commercial Fittings

Ultima® Selectronic® Concealed Urinal Flush Valves – Piston-Type 0.5 gpf/1.9 Lpf



- For urinals with 3/4" (19 mm) back spud
- POWER KIT MUST BE PURCHASED SEPARATELY
- FOR INSTALLATIONS WITH REAR ACCESS
- Includes 6" x 6" (152 x 152 mm) chrome cover plate
- Touchless operation limits the spread of germs
- Exclusive DynaClean® self-cleaning wiper spring technology
- Integral wiper spring cleans refill orifice with every flush to help prevent valve run-on
- Fully mechanical manual override can operate without power
- Proprietary brass alloy resists dezincification
- 0.5 gpf/1.9 Lpf



Description	SKU	Color	List Price
Ultima™ Selectronic Concealed Urinal Flush Valve, Base Model, Piston-Type, 0.5 gpf/1.9 Lpf	606B305.007	No Finish	664

Required Components:

Selectronic® CR-P2 Lithium Power Kit	PK00.CRP	No Finish	42
Selectronic® Hard Wired AC Power Kit	PK00.HAC	No Finish	129
Selectronic® Multi-AC Power Kit	PK00.MAC	No Finish	72
Selectronic® Plug-In AC Power Kit	PK00.PAC	No Finish	94
Selectronic® PWRX® Power Kit	PK00.WRK	No Finish	158

Optional Components:

Selectronic® Battery Back-Up Kit	PK00.BBU	No Finish	88
----------------------------------	----------	-----------	----



- For urinals with 3/4" (19 mm) back spud
- POWER KIT MUST BE PURCHASED SEPARATELY
- FOR INSTALLATIONS WITH FRONT ACCESS
- Includes Wall Box with Vandal-Resistant Brushed S.S. Cover
- Touchless operation limits the spread of germs
- Exclusive DynaClean® self-cleaning wiper spring technology
- Integral wiper spring cleans refill orifice with every flush to help prevent valve run-on
- Fully mechanical manual override can operate without power
- Proprietary brass alloy resists dezincification
- 0.5 gpf/1.9 Lpf



Description	SKU	Color	List Price
Ultima™ Selectronic Concealed Urinal Flush Valve with Wall Box, Base Model, Piston-Type, 0.5 gpf/1.9 Lpf	606B505.007	No Finish	1,041

Required Components:

Selectronic® CR-P2 Lithium Power Kit	PK00.CRP	No Finish	42
Selectronic® Hard Wired AC Power Kit	PK00.HAC	No Finish	129
Selectronic® Multi-AC Power Kit	PK00.MAC	No Finish	72
Selectronic® Plug-In AC Power Kit	PK00.PAC	No Finish	94
Selectronic® PWRX® Power Kit	PK00.WRK	No Finish	158

Optional Components:

Selectronic® Battery Back-Up Kit	PK00.BBU	No Finish	88
----------------------------------	----------	-----------	----

Commercial Fittings

Ultima® Selectronic® Concealed Urinal Flush Valves – Piston-Type 0.125 gpf/0.5 Lpf



- For urinals with 3/4" (19 mm) back spud
- POWER KIT MUST BE PURCHASED SEPARATELY
- FOR INSTALLATIONS WITH REAR ACCESS
- Includes 6" x 6" (152 x 152 mm) chrome cover plate
- Touchless operation limits the spread of germs
- Exclusive DynaClean® self-cleaning wiper spring technology
- Integral wiper spring cleans refill orifice with every flush to help prevent valve run-on
- Fully mechanical manual override can operate without power
- Proprietary brass alloy resists dezincification
- 0.125 gpf/0.5 Lpf



Description	SKU	Color	List Price
Ultima™ Selectronic Concealed Urinal Flush Valve, Base Model, Piston-Type, 0.125 gpf/0.5 Lpf	606B301.007	No Finish	664

Required Components:

Selectronic® CR-P2 Lithium Power Kit	PK00.CRP	No Finish	42
Selectronic® Hard Wired AC Power Kit	PK00.HAC	No Finish	129
Selectronic® Multi-AC Power Kit	PK00.MAC	No Finish	72
Selectronic® Plug-In AC Power Kit	PK00.PAC	No Finish	94
Selectronic® PWRX® Power Kit	PK00.WRK	No Finish	158

Optional Components:

Selectronic® Battery Back-Up Kit	PK00.BBU	No Finish	88
----------------------------------	----------	-----------	----

Flush Valves



- For urinals with 3/4" (19 mm) back spud
- POWER KIT MUST BE PURCHASED SEPARATELY
- FOR INSTALLATIONS WITH FRONT ACCESS
- Includes Wall Box with Vandal-Resistant Brushed S.S. Cover
- Touchless operation limits the spread of germs
- Exclusive DynaClean® self-cleaning wiper spring technology
- Integral wiper spring cleans refill orifice with every flush to help prevent valve run-on
- Fully mechanical manual override can operate without power
- Proprietary brass alloy resists dezincification
- 0.125 gpf/0.5 Lpf



Description	SKU	Color	List Price
Ultima™ Selectronic Concealed Urinal Flush Valve with Wall Box, Base Model, Piston-Type, 0.125 gpf/0.5 Lpf	606B501.007	No Finish	1,041

Required Components:

Selectronic® CR-P2 Lithium Power Kit	PK00.CRP	No Finish	42
Selectronic® Hard Wired AC Power Kit	PK00.HAC	No Finish	129
Selectronic® Multi-AC Power Kit	PK00.MAC	No Finish	72
Selectronic® Plug-In AC Power Kit	PK00.PAC	No Finish	94
Selectronic® PWRX® Power Kit	PK00.WRK	No Finish	158

Optional Components:

Selectronic® Battery Back-Up Kit	PK00.BBU	No Finish	88
----------------------------------	----------	-----------	----

Selectronic® Power Kit

Commercial Fittings

Ultima® Manual Toilet Flush Valves – Piston-Type



- For flushometer bowls with 1-1/2" (38 mm) exposed top spud
- Exclusive DynaClean® self-cleaning wiper spring technology
- Integral wiper spring cleans refill orifice with every flush to help prevent valve run-on
- ADA-compliant non-hold open handle provides automatic shut-off after every flush
- Piston operation delivers superior flush accuracy and repeatability
- High back pressure vacuum breaker helps prevent dripping
- Can be install left- or right-handed
- No external volume adjustment
- 11-1/2" (292 mm) rough-in



Description	SKU	Color	List Price
Ultima™ Manual Toilet Flush Valve, Piston-Type, 1.1 gpf/4.2 Lpf	6047111.002	Polished Chrome	265
Ultima™ Manual Toilet Flush Valve, Piston-Type, 1.28 gpf/4.8 Lpf	6047121.002	Polished Chrome	265
Ultima™ Manual Toilet Flush Valve, Piston-Type, 1.6 gpf/6.0 Lpf	6047161.002	Polished Chrome	265



- For flushometer bowls with 1-1/2" (38 mm) exposed top spud
- Exclusive DynaClean® self-cleaning wiper spring technology
- Integral wiper spring cleans refill orifice with every flush to help prevent valve run-on
- ADA-compliant non-hold open handle provides automatic shut-off after every flush
- Piston operation delivers superior flush accuracy and repeatability
- High back pressure vacuum breaker helps prevent dripping
- Can be install left- or right-handed
- No external volume adjustment
- 27" (686 mm) rough-in. Pipe can be cut during installation



Description	SKU	Color	List Price
Ultima™ Manual Toilet Flush Valve, Piston-Type, 1.28 gpf/4.8 Lpf, 27-Inch Rough-In	6047122.002	Polished Chrome	290
Ultima™ Manual Toilet Flush Valve, Piston-Type, 1.6 gpf/6.0 Lpf, 27-Inch Rough-In	6047162.002	Polished Chrome	290



- Does not include stop valve, inlet assembly, spud coupling or vacuum breaker tube
- Exclusive DynaClean® self-cleaning wiper spring technology
- Integral wiper spring cleans refill orifice with every flush to help prevent valve run-on
- ADA-compliant non-hold open handle provides automatic shut-off after every flush
- Piston operation delivers superior flush accuracy and repeatability
- Can be install left- or right-handed
- No external volume adjustment



Description	SKU	Color	List Price
Ultima™ Manual Valve Only for Retrofit, Piston-Type, 1.28 gpf/4.8 Lpf	6047525.002	Polished Chrome	160
Ultima™ Manual Valve Only for Retrofit, Piston-Type, 1.6 gpf/6.0 Lpf	6047565.002	Polished Chrome	160

Flush Valves

Commercial Fittings

Ultima® Manual Exposed Clinic Sink Flush Valves – Piston-Type



- For clinic sinks with 1-½" (38 mm) exposed top spud
- Exclusive DynaClean® self-cleaning wiper spring technology
- Integral wiper spring cleans refill orifice with every flush to help prevent valve run-on
- ADA-compliant non-hold open handle provides automatic shut-off after every flush
- Piston operation delivers superior flush accuracy and repeatability
- High back pressure vacuum breaker helps prevent dripping
- Can be install left- or right-handed
- No external volume adjustment
- 24" (610 mm) rough-in. Pipe can be cut during installation
- 6.5 gpf/24.6 Lpf



Description	SKU	Color	List Price
Ultima™ Manual Clinic Sink Flush Valve, Piston-Type, 6.5 gpf/24.6 Lpf, 24-Inch Rough-In	6047117.002	Polished Chrome	303



- Does not include stop valve, inlet assembly, spud coupling or vacuum breaker tube
- Exclusive DynaClean® self-cleaning wiper spring technology
- Integral wiper spring cleans refill orifice with every flush to help prevent valve run-on
- ADA-compliant non-hold open handle provides automatic shut-off after every flush
- Piston operation delivers superior flush accuracy and repeatability
- Can be install left- or right-handed
- No external volume adjustment
- 6.5 gpf/24.6 Lpf



Description	SKU	Color	List Price
Ultima™ Manual Valve Only for Retrofit, Piston-Type, 6.5 gpf/24.6 Lpf	6047517.002	Polished Chrome	173

Commercial Fittings

Ultima® Manual Urinal Flush Valves – Piston-Type



- For urinals with 3/4" (19 mm) exposed top spud
- Exclusive DynaClean® self-cleaning wiper spring technology
- Integral wiper spring cleans refill orifice with every flush to help prevent valve run-on
- ADA-compliant non-hold open handle provides automatic shut-off after every flush
- Piston operation delivers superior flush accuracy and repeatability
- High back pressure vacuum breaker helps prevent dripping
- Can be install left- or right-handed
- No external volume adjustment
- 11-1/2" (292 mm) rough-in



Description	SKU	Color	List Price
Ultima™ Manual Urinal Flush Valve, Piston-Type, 1.0 gpf/3.8 Lpf	6045101.002	Polished Chrome	265
Ultima™ Manual Urinal Flush Valve, Piston-Type, 0.125 gpf/0.5 Lpf	6045013.002	Polished Chrome	265
Ultima™ Manual Urinal Flush Valve, Piston-Type, 0.5 gpf/1.9 Lpf	6045051.002	Polished Chrome	265



- For urinals with 1-1/4" (32 mm) exposed top spud
- Exclusive DynaClean® self-cleaning wiper spring technology
- Integral wiper spring cleans refill orifice with every flush to help prevent valve run-on
- ADA-compliant non-hold open handle provides automatic shut-off after every flush
- Piston operation delivers superior flush accuracy and repeatability
- High back pressure vacuum breaker helps prevent dripping
- Can be install left- or right-handed
- No external volume adjustment
- 11-1/2" (292 mm) rough-in
- 1.0 gpf/3.8 Lpf



Description	SKU	Color	List Price
Ultima™ Manual Urinal Flush Valve, Piston-Type, 1.0 gpf/3.8 Lpf, 1-1/4-Inch	6045601.002	Polished Chrome	265



- Does not include stop valve, inlet assembly, spud coupling or vacuum breaker tube
- Exclusive DynaClean® self-cleaning wiper spring technology
- Integral wiper spring cleans refill orifice with every flush to help prevent valve run-on
- ADA-compliant non-hold open handle provides automatic shut-off after every flush
- Piston operation delivers superior flush accuracy and repeatability
- Can be install left- or right-handed
- No external volume adjustment



Description	SKU	Color	List Price
Ultima™ Manual Valve Only for Retrofit, Piston-Type, 1.0 gpf/3.8 Lpf	6045510.002	Polished Chrome	160
Ultima™ Manual Valve Only for Retrofit, Piston-Type, 0.5 gpf/1.9 Lpf	6045505.002	Polished Chrome	160

Commercial Fittings









Bedpan Washers Accessories

	Description	SKU	Color/Finish	List Price
	<p>Bedpan Washer Diverter Assembly With Straight Tube</p> <ul style="list-style-type: none"> • Straight vacuum breaker tube • Operates at 1.1 gpf/4.2 Lpf, 1.28 gpf/4.8 Lpf and 1.6 gpf/6.0 Lpf • Rugged brass construction • Counter balanced pivot assembly • Includes wall support, 1-1/2" (38 mm) spud coupling and flange • Includes high back pressure vacuum breaker • Diverter assembly only. Flush valve sold separately 	6047800.002	Polished Chrome	401
	<p>Bedpan Washer Diverter Assembly With Offset Tube</p> <ul style="list-style-type: none"> • Offset vacuum breaker tube • Operates at 1.1 gpf/4.2 Lpf, 1.28 gpf/4.8 Lpf and 1.6 gpf/6.0 Lpf • Rugged brass construction • Counter balanced pivot assembly • Includes wall support, 1-1/2-inch (38 mm) spud coupling and flange • Includes high back pressure vacuum breaker • Diverter assembly only. Flush valve sold separately 	6047815.002	Polished Chrome	401
	<p>Ultima™ Manual Flush Valve With Bedpan Washer Assembly, Straight Tube, 1.6 gpf/6.0 Lpf</p> <ul style="list-style-type: none"> • Piston-type manual flush valve • Straight bedpan washer diverter assembly with counter balanced pivot assembly • Rugged brass construction • Includes stop valve, sweat solder assembly, wall support, 1-1/2" (38 mm) spud coupling and flange 	6047860.002	Polished Chrome	582

Flush valve accessories

Commercial Fittings







Bedpan Washers Accessories

	Description	SKU	Color/Finish	List Price
 	<p>Ultima™ Manual Flush Valve With Bedpan Washer Assembly, Straight Tube, 1.28 gpf/4.8 Lpf</p> <ul style="list-style-type: none"> • Piston-type manual flush valve • Straight bedpan washer diverter assembly with counter balanced pivot assembly • Rugged brass construction • Includes stop valve, sweat solder assembly, wall support, 1-½" (38 mm) spud coupling and flange 	6047820.002	Polished Chrome	582 
	<p>Ultima™ Manual Flush Valve With Bedpan Washer Assembly, Offset Tube, 1.6 gpf/6.0 Lpf</p> <ul style="list-style-type: none"> • Piston-type manual flush valve • Offset bedpan washer diverter assembly with counter balanced pivot assembly • Rugged brass construction • Includes stop valve, sweat solder assembly, wall support, 1-½" (38 mm) spud coupling and flange 	6047861.002	Polished Chrome	582 
 	<p>Ultima™ Manual Flush Valve With Bedpan Washer Assembly, Offset Tube, 1.28 gpf/4.8 Lpf</p> <ul style="list-style-type: none"> • Piston-type manual flush valve • Offset bedpan washer diverter assembly with counter balanced pivot assembly • Rugged brass construction • Includes stop valve, sweat solder assembly, wall support, 1-½" (38 mm) spud coupling and flange 	6047821.002	Polished Chrome	582 

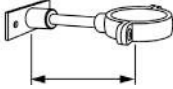
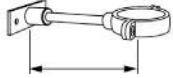
Flush Valves

Commercial Fittings



Flush Valve Accessories

	Description	SKU	Color/Finish	List Price
	<p>Split-Ring Pipe Support for Toilet Flush Valve, 2-1/2 - 3-Inch Long</p> <ul style="list-style-type: none"> • For 1-1/2" (38 mm) diameter tailpiece • Adjustable distance from wall to center of pipe: Up to 2-1/2" - 3" (64 - 76 mm) 	6065822.002	Polished Chrome	38
	<p>Split-Ring Pipe Support for Toilet Flush Valve, Up to 6-Inch Long</p> <ul style="list-style-type: none"> • For 1-1/2" (38 mm) diameter tailpiece • Adjustable distance from wall to center of pipe: Up to 6" (152 mm) 	6065862.002	Polished Chrome	64
	<p>Trap Primer</p> <ul style="list-style-type: none"> • Trap primer diverts a small amount of water from each flush to the floor drain to maintain the water seal • Water seal prevents sewer gases from escaping into the air • For exposed, top spud toilet flush valves • Operates at 1.1 - 1.6 gpf (4.2 - 6.0 Lpf) 	6065830.002	Polished Chrome	126 
	<p>Adjustable Tailpiece for 5-1/4 - 6-1/4-Inch Rough-In (3-1/8-Inch Length)</p> <ul style="list-style-type: none"> • For 5-1/4" to 6-1/4" rough-in (3-1/8" overall length) • Polished Chrome finish 	M962833-0020A	Polished Chrome	33
	<p>Adjustable Tailpiece for 6-1/4 - 7-1/4-Inch Rough-In (4-1/8-Inch Length)</p> <ul style="list-style-type: none"> • For 6-1/4" to 7-1/4" rough-in (4-1/8" overall length) • Polished Chrome finish 	M962834-0020A	Polished Chrome	48
	<p>Adjustable Tailpiece for 7-1/4 - 8-1/4-Inch Rough-In (5-1/8-Inch Length)</p> <ul style="list-style-type: none"> • For 7-1/4" to 8-1/4" rough-in (5-1/8" overall length) • Polished Chrome finish 	M962835-0020A	Polished Chrome	61

Flush Valves

Commercial Fittings

Flush Valve Accessories

	Description	SKU	Color/Finish	List Price
	Adjustable Tailpiece for 8-1/4 – 9-1/4-Inch Rough-In (6-1/8-Inch Length) <ul style="list-style-type: none"> • For 8-1/4" to 9-1/4" rough-in (6-1/8" overall length) • Polished Chrome finish 	M962836-0020A	Polished Chrome	58
	24-Inch Long Vacuum Breaker Tube for Toilet Flush Valve <ul style="list-style-type: none"> • For exposed toilet flush valves • 24" (610 mm) overall length • Allows for 27" (686 mm) maximum rough-in • Can be cut to length for a shorter rough-in* • Includes high back pressure vacuum breaker assembly and coupling nut • Rough-in higher than 16" (406 mm) not recommended for Selectronic® toilet flush valves* 	M964413-0020A	Polished Chrome	139
	3/4-Inch Vacuum Breaker Tube for Urinal Flush Valves <ul style="list-style-type: none"> • For exposed urinal flush valves • 12-1/2" (318 mm) overall length. 4" (102 mm) longer than standard • Allows for 15-1/2" (394 mm) maximum rough-in • Can be cut to length for a shorter rough-in • Includes high back pressure vacuum breaker assembly and coupling nut 	M964446-0020A	Polished Chrome	86







Side-Mount Operator for Manual Flush Valve

	<ul style="list-style-type: none"> • Includes 4 C-sized alkaline batteries • For American Standard, Sloan & Zurn diaphragm flush valves • Easily retrofit manual valves to automatic operation to limit the spread of germs • Installs easily without needing to shut off water 			
Description	SKU	Color	List Price	
Sensor-Operated Side-Mount Retrofit for Diaphragm Flush Valve's	SMGODIA.002	Polished Chrome	335	
	<ul style="list-style-type: none"> • Includes 4 C-sized alkaline batteries • For American Standard, Sloan GEM & Zurn MetroFlush piston flush valves • Easily retrofit manual valves to automatic operation to limit the spread of germs • Installs easily without needing to shut off water 			
Description	SKU	Color	List Price	
Sensor-Operated Side-Mount Retrofit for Piston Flush Valve's	SMGOPIS.002	Polished Chrome	335	
	<ul style="list-style-type: none"> • Allows side-mount operator to be tilted downward • Ideal for high rough-in installations like bedpan washers • Great solution to detect small children 			
Description	SKU	Color	List Price	
High Rough-In Kit for Side-Mount Retrofit	SMGOHRK.007	No Finish	58	

* Rough-in higher than 16" (406 mm) not recommended for Selectronic® toilet flush valves.



Commercial Fittings

Shower Valve Accessories





	Description	SKU	Color/Finish	List Price
	Deep Rough-in Kit for Pressure Balance Valve <ul style="list-style-type: none"> • For All TU series pressure balance valve trim kits used in conjunction with Flash® shower rough-in valves • Provides additional ¾" (19 mm) rough-in depth • Includes two 4" (102 mm) screws for trim kit installation and handle adaptor screw • Specify color when ordering 	M970649-0020A	Polished Chrome	43
		M970649-2780A	Legacy Bronze	52
		M970649-2950A	Brushed Nickel	47
	Pressure Balance Cartridge for Flash® <ul style="list-style-type: none"> • Suitable for both standard installation & BTB solution • Includes removal ring to aid in removal of cartridge from valve 	M970654-0070A	No Finish	37
	Removal Ring <ul style="list-style-type: none"> • Aids in removing cartridge from valve 	M970648-0070A	No Finish	7
	Retaining Ring <ul style="list-style-type: none"> • For use with all Flash® shower rough-in valves • Secure cartridges/test cap to valve body • Made of stainless steel 	M970452-0070A	No Finish	11
	Service Stops <ul style="list-style-type: none"> • For use with all Flash® shower rough-in valves • Set of two 	M970451-0070A	No Finish	15
	Flush Plug Assembly <ul style="list-style-type: none"> • Two way flush plug assembly 	M970545-0070A	No Finish	11
	Conversion Kit for TRIMendous® Trim Kits <ul style="list-style-type: none"> • Converts TRIMendous® trim kits to work with all Flash® shower rough-in valves • For use with the following T series trim kits: Berwick®, Colony® PRO, Edgemere®, Fluent®, Patience®, Serin®, Studio® S, Times Square®, Town Square® S, Townsend® • NOT for use with the following TRIMendous® trim kits: Portsmouth®, Quentin®, Reliant 3®, Town Square® (T555520 series), Colony Soft®, Seva®, Studio • Available in Chrome 	M970645-0070A	No Finish	83

Commercial Fittings

Shower Valve Accessories

	Description	SKU	Color/Finish	List Price
	Locking Cam Screw Set <ul style="list-style-type: none"> • For use with all Flash® shower rough-in valves • Used for thin wall applications • Set of two 	M970453-0070A	No Finish	11
	Cartridge Removal Tool <ul style="list-style-type: none"> • Universal cartridge removal tool for shower valves 	M970652-0070A	No Finish	57

Sink Drains and Faucet Accessories



	Mechanical Mixing Valve <ul style="list-style-type: none"> • ½" (13 mm) supply inlets • Duck bill checks 	021943-0070A	No Finish	92
	Grid Strainer Drain for Sinks <ul style="list-style-type: none"> • With overflow • 1-¼" (32 mm) tailpiece • Brass construction 	2411015.002	Polished Chrome	48
	Offset Grid Strainer Drain for Sinks <ul style="list-style-type: none"> • For wheelchair lavatory • With overflow • 4-¾" (114 mm) – 5" (127 mm) offset • 1-¼" (32 mm) tailpiece • Brass construction 	7723018.002	Polished Chrome	119
	Grid Strainer Drain for Sinks <ul style="list-style-type: none"> • For 3-½" (89 mm) outlet sink • 3" (76 mm) I.P.S. connection • Brass construction 	7721038.002	Polished Chrome	129

Commercial Fittings

Flow Controls – 2.2 gpm/8.3 L/min maximum







	Description	SKU	Color/Finish	List Price
	2.2 gpm Aerator	066070-0020A	Polished Chrome	7
	<ul style="list-style-type: none"> • 15/16" (24 mm) male threads • Specify finish when ordering 	066070-0750A	Stainless Steel	9
		066070-2950A	Brushed Nickel	11
	2.2 gpm Aerator	066111-0020A	Polished Chrome	11
	<ul style="list-style-type: none"> • 55/64" (22 mm) female threads • Available in Polished Chrome 			

Flow Controls – 1.5 gpm/5.7 L/min maximum

	1.5 gpm/5.7 L/ min Pressure-Compensating Vandal-Resistant Aerator With Key	M922887-0020A	Polished Chrome	19
	<ul style="list-style-type: none"> • 15/16" (8 mm) male threads • 1.5 gpm/5.7 L/min maximum • Available in Chrome • Includes aerated spray and key 	M922887-2950A	Brushed Nickel	19
	1.5 gpm/5.7 L/min Pressure-Compensating Vandal-Resistant Aerator With Key	M922888-0020A	Polished Chrome	17
	<ul style="list-style-type: none"> • 55/64" (21 mm) female threads • 1.5 gpm/5.7 L/min maximum • Available in Chrome • Includes aerated spray and key 			
	1.5 gpm Aerator	M922883-0020A	Polished Chrome	12
	<ul style="list-style-type: none"> • Pressure-compensating non-aerated laminar fl w outlet • 15/16" (24 mm) male threads • Available in Polished Chrome 			
	1.5 gpm Aerator	M922883-0020A	Polished Chrome	12
	<ul style="list-style-type: none"> • Pressure-compensating non-aerated laminar fl w outlet • 55/64" (22 mm) female threads • Available in Polished Chrome 			
	1.5 gpm Aerator	M922885-0020A	Polished Chrome	21
	<ul style="list-style-type: none"> • Pressure-compensating vandal-resistant non-aerated laminar fl w outlet with key • 15/16" (24 mm) male threads • Available in Polished Chrome 			
	1.5 gpm Aerator	M922886-0020A	Polished Chrome	21
	<ul style="list-style-type: none"> • Pressure-Compensating Vandal-Resistant Non-Aerated Laminar Flow Outlet With Key • 55/64" (22 mm) female threads • Available in Polished Chrome 			

Commercial Fittings

Flow Controls – 1.0 gpm/3.8 L/min maximum



	Description	SKU	Color/Finish	List Price
	<p>1.0 gpm/3.8 L/min Pressure-Compensating Aerator</p> <ul style="list-style-type: none"> • 15/16" (24 mm) male threads • 1.0 gpm/3.8 L/min maximum • Specify color when ordering • Includes aerated spray 	M922991-0020A	Polished Chrome	8
	<p>1.0 gpm/3.8 L/min Pressure-Compensating Aerator</p> <ul style="list-style-type: none"> • 55/64" (21 mm) female threads • 1.0 gpm/3.8 L/min maximum • Available in Chrome • Includes aerated spray 	M922992-0020A	Polished Chrome	8
	<p>1.0 gpm/3.8 L/min Pressure-Compensating Vandal-Resistant Aerator With Key</p> <ul style="list-style-type: none"> • For use on metering lavatory faucet series 1340 including pillar tap • 15/16" (24 mm) male threads • 1.0 gpm/3.8 L/min maximum • Available in Chrome • Includes aerated spray and key 	M922996-0020A	Polished Chrome	19
	<p>1.0 gpm/3.8 L/min Pressure-Compensating Vandal-Resistant Aerator With Key</p> <ul style="list-style-type: none"> • For use on metering spread and center set lavatory faucet series 1340 • 55/64" (21 mm) female threads • 1.0 gpm/3.8 L/min maximum • Available in Chrome • Includes aerated spray and key 	M922997-0020A	Polished Chrome	19
	<p>1.0 gpm Aerator</p> <ul style="list-style-type: none"> • Pressure-compensating vandal-resistant non-aerated laminar flow outlet with key • 15/16" (24 mm) male threads • Available in Polished Chrome 	M922892-0020A	Polished Chrome	19
	<p>1.0 gpm Aerator</p> <ul style="list-style-type: none"> • Pressure-compensating vandal-resistant non-aerated laminar flow outlet with key • 55/64" (22 mm) female threads • Available in Polished Chrome 	M922893-0020A	Polished Chrome	19

Commercial Fittings

Flow Controls – 0.5 gpm/1.9 L/min maximum







	Description	SKU	Color/Finish	List Price
	<p>0.5 gpm/1.9 L/min Pressure-Compensating Non-Aerated Spray</p> <ul style="list-style-type: none"> • 15/16" (24 mm) male threads • 0.5 gpm/1.9 L/min maximum • Available in Chrome • Includes non-aerated spray 	M922901-0020A	Polished Chrome	10
	<p>0.5 gpm/1.9 L/min Pressure-Compensating Non-Aerated Spray</p> <ul style="list-style-type: none"> • 55/64" (21 mm) female threads • 0.5 gpm/1.9 L/min maximum • Available in Chrome • Includes non-aerated spray 	M922903-0020A	Polished Chrome	11
	<p>0.5 gpm Non-Aerated Spray With Key</p> <ul style="list-style-type: none"> • For use on 605X, 2506 & 250B, 5500, 6500, 7295, 1340 series faucets • Vandal resistant • 15/16" (24 mm) male threads • 0.5 gpm/1.9 L/min maximum • Available in Chrome • Includes non-aerated spray and key 	066508-0020A	Polished Chrome	19
	<p>0.5 gpm Non-Aerated Spray</p> <ul style="list-style-type: none"> • For use on 6500, 6502, 6503, 6532 series spread lavatory faucets • Vandal-resistant • 55/64" (21 mm) female threads • 0.5 gpm/1.9 L/min maximum • Available in Chrome 	066074-0020A	Polished Chrome	19

Flow Controls – 0.35 gpm/1.3 L/min maximum

	<p>0.35 gpm Aerator</p> <ul style="list-style-type: none"> • Vandal-resistant pressure-compensating non-aerated spray with key • 15/16" (24 mm) male threads • Available in Polished Chrome 	M922286-0020A	Polished Chrome	19
	<p>0.35 gpm Aerator</p> <ul style="list-style-type: none"> • Vandal-resistant pressure-compensating non-aerated spray with key • 55/64" (22 mm) female threads • Available in Polished Chrome 	M922858-0020A	Polished Chrome	19

Commercial Fittings

Other Flow Controls

	Description	SKU	Color/Finish	List Price
 	<p>1.5 gpm Aerator</p> <ul style="list-style-type: none"> • Pressure-compensating laminar flow outlet M21.5X1 cache-style with key • Used in Selectronic® faucet with gooseneck spout 	M922993-0070A	No Finish	6
	<p>0.5 gpm Aerator</p> <ul style="list-style-type: none"> • Used in Selectronic® faucet with gooseneck spout • Pressure-compensating laminar flow outlet M21.5X1 cache-style with key 	M922871-0070A	No Finish	12
 	<p>1.5 gpm Aerator</p> <ul style="list-style-type: none"> • Pressure-compensating laminar flow outlet with swivel face M24 slim-style with key • Used in NextGen™ (775X Series) and Paradigm® (702X Series) 	M964171-0070A	No Finish	10
	<p>0.5 gpm Aerator</p> <ul style="list-style-type: none"> • Pressure-compensating multi-laminar spray M24 slim-style with key • Used in NextGen™ (775X Series) and Paradigm® (702X Series) 	M964172-0070A	No Finish	12
	<p>0.35 gpm Aerator</p> <ul style="list-style-type: none"> • Vandal-resistant PCA non-aerated multi-laminar spray with key • Used in NextGen™ (775X Series) and Paradigm® (702X Series) 	M910297-0070A	No Finish	40

Commercial Fittings

Commercial Faucet Modifications and Aerator Cross Reference

Faucet Modifications How to Order

ORDERING

- Special manufacturing or modification requests can be made through your sales rep or customer care
- You will need to provide basic information regarding the request for review by category and manufacturing teams

PRICING

- Pricing will be provided by sales rep after review of request

CONDITIONS

- Some modifications may not be feasible. Each request will be reviewed by category and manufacturing
- Order minimum: 100 pieces. Exceptions will be considered on large job quotes
- A one-time setup charge may be applied to modification

Aerator Cross Reference

				_V035*	_V05	_V10	_LV10	_V15	_LV15
				0.35 gpm (1.3 L/min) Vandal-Resistant PCA Non-Aerated Multi-Laminar Spray	0.5 gpm (1.9 L/min) Vandal-Resistant PCA Non-Aerated Multi-Laminar Spray	1.0 gpm (3.8 L/min) Vandal-Resistant PCA Aerator	1.0 gpm (3.8 L/min) Vandal-Resistant PCA Laminar Flow Outlet	1.5 gpm (5.7 L/min) Vandal-Resistant PCA Aerator	1.5 gpm (5.7 L/min) Vandal-Resistant PCA Laminar Flow Outlet
Name	Lavatory Series	Aerator Type	Available Finishes						
Selectronic® Cast	605X.10X	Male	002	M922286	066508	M922996	M922892	M922887	M922885
Selectronic Goosneck	605X.16X	Cache	Plain, no finish	M964154	M922871	N/A	M922908	N/A	M922993
Innsbrook®	605X.20X	Male	002	M922286	066508	M922996	M922892	M922887	M922885
Serin®	2064 & 206B T064 & T06B	Female	002, 295	M964964	M964847	N/A	N/A	wN/A	M964913
NextGen	775 & 775B	Slim	Plain, no finish	M910297	M964172	N/A	N/A	N/A	M964171
Paradigm®	7025 & 702B	Slim	Plain, no finish	M910297	M964172	N/A	N/A	N/A	M964171
Moments®	2506 & 250B	Male	002, 295	M922286	066508	M922996	M922892	M922887	M922885
Metering	1340.109 1340.119 1340.225 1340.825	Male	002	M922286	066508	M922996	M922892	M922887	M922885
Monterrey®	5500 6500	Male	002	M922286	066508	M922996	M922892	M922887	M922885
	6540 7500	Female	002	M922858	066074	M922997	M922893	M922888	M922886
Name	Kitchen Series	Aerator Type	Available Finishes						
Heritage®	7295	Male	002	M922286	066508	M922996	M922892	M922887	M922885
	7100 7292 7293 7298	Female	002	M922858	066074	M922997	M922893	M922888	M922886
	All	Female	002	M922858	066074	M922997	M922893	M922888	M922886
	All	Female	002	M922858	066074	M922997	M922893	M922888	M922886
Reliant 3®	7385	Male	002	M922286	066508	M922996	M922892	M922887	M922885

Additional modifications available.

* Meets the CalGreen Code.

Notes

Commercial Fixtures

Back Outlet VorMax® HETs

Style

Stand out style that fits in life today and will stay looking good for years to come, leaving your bathroom looking its best.



2882107 Combo
With Seat: 5055A65C

2882107 Combo
With Seat: 5901100

209AA138 Combo
With Seat: 5055A65C

209AA137 Combo
With Seat: 5901100

LH Lever: 7381740-200 RH Lever: 7381799-200

Technology

Innovation that makes life easier and more enjoyable by solving the little and not so little problems of everyday living.

CleanCurve® Rim Design: Unique rim design eliminates hidden, hard to reach surfaces where dirt and build-up hide.

EverClean® Surface: Toilet surface is over 2X smoother than ordinary toilet surfaces. Includes antimicrobial properties that inhibit the growth of stain and odor causing bacteria, mold and mildew on the surface.

Noise: Creates 50% less noise than pressure-assist technology toilets.

VorMax Flushing Action: Two patented flush valves, maximum rinsing power for the cleanest flush.*

*Compared to American Standard Champion toilets.

Performance

Beauty you can see and feel inside and out that comes from our use of long-lasting, solid materials and our flawless attention to details that create dependable performance for life.

Flush Score: Obtains best 1,000g MaP score using a water conserving 1.28 gpf volume.†

Drain Line Carry: Meets all applicable drain line carry requirements and performs just as well as all pressure-assist HETs.

Seat Cover Flushing: Consistently flushes and removes paper seat covers unlike many pressure-assist toilets which tend to rip and leave behind paper.

†MaP testing performed by IAPMO R&T Lab. MaP report conducted by Gauley Associates Ltd. and Koeller and Company.

EverClean®

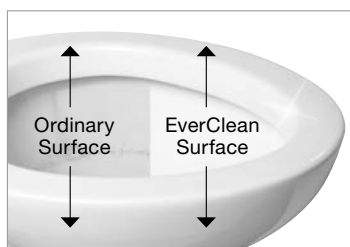

Monthly cost to vacuum, clean and remove trash from a four-story facility, including the restrooms, with a crew of four people can be as high as \$3,600. The cost can be higher depending on rentable square feet, cleaning frequency, building type, density and access. Burdened with this high cost, many facilities are looking for more cost-effective options.

American Standard's exclusive EverClean antimicrobial technology provides such an option. Many of our commercial chinaware products have our EverClean surface. This surface helps inhibit the growth of stain and odor causing bacteria, mold and mildew, which simply means that it helps keep the chinaware products cleaner longer.

For more information on American Standard Brands, please visit our website at www.americanstandard.com or call 1-800-442-1902.

Commercial Fixtures

Exceptional Performance

Performance

American Standard has the best selection of high-efficiency commercial fixtures with exceptional performance. Our new AFWall® Millennium® toilet, an industry standard, paired with our Selectronic® flush valve, uses as little as 1.1 gpf/4.2 Lpf and easily handles 1,000 grams of bulk waste.

Features and Benefit

- 20-31% water savings while providing exceptional bowl performance
- Matching flush valve available for superior performance
- High efficiency and universal—performs at 1.1 to 1.6 gpf (4.2 to 6.0 Lpf)
- EverClean® Antimicrobial Surface
- Exceptional flushing performance

MaP Testing

Based on independent test of Maximum Performance (MaP). See <http://MaP-testing.com>.

Product	1.1 gpf	MaP Score* 1.28 gpf	1.6 gpf
Baby Devoro™ two-piece	—	500 g	—
Baby Devoro Flushometer	—	800 g	800 g
Madera™	1,000 g	1,000 g	1,000 g
Madera Youth™	—	800 g	—
AFWall Millennium FloWise	1,000 g	1,000 g	1,000 g
Priolo® with EverClean	1,000 g	1,000 g	1,000 g
Huron® with EverClean	—	1,000 g	1,000 g
Right Width® FloWise	—	1,000 g	1,000 g

*MaP Score Performance is attained by using both American Standard chinaware and flush valves.



AFWall Millennium FloWise Elongated Top Spud with EverClean
(Shown with American Standard Selectronic® Battery-Powered Flush Valve – sold separately)



Murro® CHO Lavatory 0955.001EC
Above Deck Mixing Selectronic Faucet and Vitreous China Shroud with EverClean

For more information on American Standard Brands, please visit our website at www.americanstandard.com or call 1-800-442-1902.

Commercial Fixtures

Commercial/Institutional Fixtures Overview

Commercial Sinks





Countertop		Healthcare	Wall-hung	
				

Commercial Toilets

Baby Bowls		Flushometer Bowls		
				

Toilet Seats	Trip Levers	Toilet Tanks
		
		

Commercial Fixtures

Institutional/Utility			Enameled Cast Iron	
				

Commercial Toilets

Pressure-Assisted and Gravity Flush				
				

Urinals			Parts	
				

Commercial Fixtures

Above Counter Sinks



Mezzo® Semi-Countertop Sink With 4-Inch Centerset

- Self-rimming, semi-countertop sink
- Space saving design installs on a minimum countertop depth of 13" (330 mm)
- Faucet holes on 4" (102 mm) centers
- Generous bowl area with recessed self-draining deck
- Rear overflow
- Made from fine fi e clay
- Supplied with template, sealant and mounting kit

Nominal Dimensions:

21-1/2 in x 22 in (546 mm x 558 mm)

Bowl Size:

19 in (wide) 15 in (front to back) 6-7/8 in (deep)



Description	Net Wt	SKU	Color	List Price
Mezzo® Semi-Countertop Sink With 4-Inch Centerset	35 lb 16.1 kg	9960403.020	White	256



Mezzo® Semi-Countertop Sink With 8-Inch Widespread

- Self-rimming, semi-countertop sink
- Space saving design installs on a minimum countertop depth of 13" (330 mm)
- Faucet holes on 8" (203 mm) centers
- Generous bowl area with recessed self-draining deck
- Rear overflow
- Made from fine fi e clay
- Supplied with template, sealant and mounting kit

Nominal Dimensions:

21-1/2 in x 22 in (546 mm x 558 mm)

Bowl Size:

19 in (wide) 15 in (front to back) 6-7/8 in (deep)



Description	Net Wt	SKU	Color	List Price
Mezzo® Semi-Countertop Sink With 8-Inch Widespread	35 lb 16.1 kg	9960803.020	White	256



Mezzo® Semi-Countertop Sink With Center Hole Only

- Self-rimming, semi-countertop sink
- Space saving design installs on a minimum countertop depth of 13" (330 mm)
- Faucet holes – center hole only
- Generous bowl area with recessed self-draining deck
- Rear overflow
- Made from fine fi e clay
- Supplied with template, sealant and mounting kit

Nominal Dimensions:

21-1/2 in x 22 in (546 mm x 558 mm)

Bowl Size:

19 in (wide) 15 in (front to back) 6-7/8 in (deep)



Description	Net Wt	SKU	Color	List Price
Mezzo® Semi-Countertop Sink With Center Hole Only	35 lb 16.1 kg	9960001.020	White	256

▷ Parts Program

ADA – When nose of bowl is maximum 34" (864 mm) from finished floor. Refer to product specification sheet for full details.

NOTE: Once an established product modification has been scheduled for production, it may not be changed and/or canceled.

Commercial Fixtures

Above Counter Sinks



Mezzo Semi-Countertop Sink Center Hole Only and Extra Right-Hand Hole

- Self-rimming, semi-countertop sink
- Space saving design installs on a minimum countertop depth of 13" (330 mm)
- Faucet holes – center hole only
- Generous bowl area with recessed self-draining deck
- Rear overflow
- Made from fine fi e clay
- Supplied with template, sealant and mounting kit
- Extra right-hand hole for soap dispenser
- Center hole only, sealed overfl w with extra hole for lotion dispenser

Nominal Dimensions:

21-1/2 in x 22 in (546 mm x 558 mm)

Bowl Size:

19 in (wide) 15 in (front to back) 6-7/8 in (deep)

Description	Net Wt	SKU	Color	List Price
Mezzo Semi-Countertop Sink Center Hole Only with Extra Hole for Lotion Dispenser	45 lb 20.4 kg	9960070.020	White	370



Mezzo Semi-Countertop Sink Less Overflow with 4-Inch Centerset

- Self-rimming, semi-countertop sink
- Space saving design installs on a minimum countertop depth of 13" (330 mm)
- Faucet holes on 4" (102 mm) centers
- Generous bowl area with recessed self-draining deck
- Less overflow
- Made from fine fi e clay
- Supplied with template, sealant and mounting kit

Nominal Dimensions:

21-1/2 in x 22 in (546 mm x 558 mm)

Bowl Size:

19 in (wide) 15 in (front to back) 6-7/8 in (deep)

Description	Net Wt	SKU	Color	List Price
Mezzo Semi-Countertop Sink Less Overflow with 4-Inch Centerset	45 lb 20.4 kg	9960904.020	White	370



Mezzo Semi-Countertop Sink Less Overflow with 8-Inch Widespread

- Self-rimming, semi-countertop sink
- Space saving design installs on a minimum countertop depth of 13" (330 mm)
- Faucet holes on 8" (203 mm) centers
- Generous bowl area with recessed self-draining deck
- Less overflow
- Made from fine fi e clay
- Supplied with template, sealant and mounting kit

Nominal Dimensions:

21-1/2 in x 22 in (546 mm x 558 mm)

Bowl Size:

19 in (wide) 15 in (front to back) 6-7/8 in (deep)

Description	Net Wt	SKU	Color	List Price
Mezzo Semi-Countertop Sink Less Overflow with 8-Inch Widespread	45 lb 20.4 kg	9960908.020	White	370

▷ Parts Program

ADA – When nose of bowl is maximum 34" (864 mm) from finished floor. Refer to product specification sheet for full details.

NOTE: Once an established product modification has been scheduled for production, it may not be changed and/or canceled.

Commercial Fixtures

Above Counter Sinks



Mezzo Semi-Countertop Sink Less Overflow with Center Hole Only

- Self-rimming, semi-countertop sink
- Space saving design installs on a minimum countertop depth of 13" (330 mm)
- Faucet holes – center hole only
- Generous bowl area with recessed self-draining deck
- Less overflow
- Made from fine fi e clay
- Supplied with template, sealant and mounting kit

Nominal Dimensions:

21-1/2 in x 22 in (546 mm x 558 mm)

Bowl Size:

19 in (wide) 15 in (front to back) 6-7/8 in (deep)

Description	Net Wt	SKU	Color	List Price
Mezzo Semi-Countertop Sink Less Overflow with Center Hole Only	45 lb 20.4 kg	9960901.020	White	370



Aqualyn® Drop-In Sink With 4-Inch Centerset

- Self-rimming oval drop-in sink
- Tapered edges for style
- Front overflow
- Supplied with cut-out template
- Made of vitreous china

Nominal Dimensions:

20-3/8 in x 17-3/8 in (517 mm x 441 mm)

Bowl Size:

16 in (wide) 10 in (front to back) 5-5/8 in (deep)



Description	Net Wt	SKU	Color	List Price
Aqualyn® Drop-In Sink With 4-Inch Centerset	17 lb 8.0 kg	0476028.020	White	90



Aqualyn® Drop-In Sink With 8-Inch Widespread

- Self-rimming oval drop-in sink
- Tapered edges for style
- Front overflow
- Supplied with cut-out template
- Made of vitreous china

Nominal Dimensions:

20-3/8 in x 17-3/8 in (517 mm x 441 mm)

Bowl Size:

16 in (wide) 10 in (front to back) 5-5/8 in (deep)



Description	Net Wt	SKU	Color	List Price
Aqualyn® Drop-In Sink With 8-Inch Widespread	19 lb 9.0 kg	0475020.020	White	90

ADA – Countertop 34" (864 mm) from finished floor. Refer to product specification sheet for full details.

Commercial Fixtures

Above Counter Sinks



Aqualyn® Drop-In Sink With Center Hole Only

- Self-rimming oval drop-in sink
- Tapered edges for style
- Front overflow
- Supplied with cut-out template
- Made of vitreous china

Nominal Dimensions:

20-3/8 in x 17-3/8 in (517 mm x 441 mm)

Bowl Size:

16 in (wide) 10 in (front to back) 5-5/8 in (deep)



Description	Net Wt	SKU	Color	List Price
Aqualyn® Drop-In Sink With Center Hole Only	19 lb 9.0 kg	0475047.020	White	89



Aqualyn® Drop-In Sink With 4-Inch Centerset Less Overflow

- Countertop sink less overflow
- Self-rimming with cut-out template
- Made of vitreous china

Nominal Dimensions:

20-3/8 in x 17-3/8 in (517 mm x 441 mm)

Bowl Size:

16 in (wide) 10 in (front to back) 5-5/8 in (deep)



Description	Net Wt	SKU	Color	List Price
Aqualyn® Drop-In Sink With 4-Inch Centerset Less Overflow	19 lb 9.0 kg	0476928.020	White	114



Rondalyn® Drop-In Sink With 4-Inch Centerset

- Self-rimming round drop-in sink
- Tapered edges for style
- Front overflow
- Supplied with cut-out template
- Made of vitreous china

Nominal Dimensions:

19-1/8 in x 19-1/8 in (485 mm x 485 mm)

Bowl Size:

15 in (wide) 12-1/8 in (front to back) 5-3/4 in (deep)



Description	Net Wt	SKU	Color	List Price
Rondalyn® Drop-In Sink With 4-Inch Centerset	19 lb 9.0 kg	0491019.020	White	90

ADA – Countertop 34" (864 mm) from finished floor. Refer to product specification sheet for full details.

Commercial Fixtures

Under Counter Sinks



Orbit® Under Counter Sink

- Round under counter mount sink
- Unglazed rim
- Front overflow
- Supplied with under counter mounting kit and template
- Made of vitreous china

Nominal Dimensions:

15-1/2 in x 15-1/2 in (393 mm x 393 mm x 6-1/8 in)

Bowl Size:

12-3/4 in (wide) 12-3/4 in (front to back) 4-3/8 in (deep)



Description	Net Wt	SKU	Color	List Price
Orbit® Under Counter Sink	17 lb 8.0 kg	0630000.020	White	257

Separate Components:

Under Counter Mounting Kit	0 lb 0.1 kg	▷047194-0070A	No Finish	21
----------------------------	----------------	---------------	-----------	----



Ovalyn™ Small Under Counter Sink

- Under counter mount sink
- Unglazed rim
- Front overflow
- Supplied with mounting kit and template
- Made of vitreous china

Nominal Dimensions:

14-1/8 in x 17-1/8 in (358 mm x 434 mm)

Bowl Size:

15-1/16 in (wide) 12-1/16 in (front to back) 5-1/2 in (deep)

Description	Net Wt	SKU	Color	List Price
Ovalyn™ Small Under Counter Sink	17 lb 7.7 kg	0495221.020	White	89
		0495221.021	Bone	161
		0495221.222	Linen	161

Separate Components:

Under Counter Mounting Kit	0 lb 0.1 kg	▷047194-0070A	No Finish	21
----------------------------	----------------	---------------	-----------	----



Ovalyn™ Small Under Counter Sink With Glazed Underside

- Under counter mount sink with glazed underside
- Unglazed rim
- Front overflow
- Supplied with mounting kit and template
- Made of vitreous china

Nominal Dimensions:

14-3/16 in x 17-1/8 in (360 mm x 434 mm)

Bowl Size:

15-1/16 in (wide) 12-1/16 in (front to back) 5-1/2 in (deep)

Description	Net Wt	SKU	Color	List Price
Ovalyn™ Small Under Counter Sink With Glazed Underside	17 lb 7.7 kg	0495300.020	White	133

Separate Components:

Under Counter Mounting Kit	0 lb 0.1 kg	▷047194-0070A	No Finish	21
----------------------------	----------------	---------------	-----------	----

▷ Parts Program

ADA – Countertop 34" (864 mm) from finished floor. Refer to product specification sheet for full details.

Commercial Fixtures

Under Counter Sinks



Ovalyn™ Medium Under Counter Sink

- Under counter mount sink
- Unglazed rim
- Front overflow
- Supplied with mounting kit and template
- Made of vitreous china

Nominal Dimensions:

16 in x 19-1/4 in (406 mm x 488 mm)

Bowl Size:

17 in (wide) 14 in (front to back) 5-1/2 in (deep)

Description	Net Wt	SKU	Color	List Price
Ovalyn™ Medium Under Counter Sink	18 lb 8.5 kg	0496221.020	White	89
		0496221.021	Bone	161
		0496221.222	Linen	161

Separate Components:

Under Counter Mounting Kit	0 lb 0.1 kg	▷047194-0070A	No Finish	21
----------------------------	----------------	---------------	-----------	----



Ovalyn™ Medium Under Counter Sink With Glazed Underside

- Under counter mount sink with glazed underside
- Unglazed rim
- Front overflow
- Supplied with mounting kit and template
- Made of vitreous china

Nominal Dimensions:

16 in x 19-1/4 in (406 mm x 488 mm)

Bowl Size:

17 in (wide) 14 in (front to back) 5-1/2 in (deep)

Description	Net Wt	SKU	Color	List Price
Ovalyn™ Medium Under Counter Sink With Glazed Underside	18 lb 8.5 kg	0496300.020	White	133

Separate Components:

Under Counter Mounting Kit	0 lb 0.1 kg	▷047194-0070A	No Finish	21
----------------------------	----------------	---------------	-----------	----

▷ Parts Program

ADA – Countertop 34" (864 mm) from finished floor. Refer to product specification sheet for full details.

Commercial Fixtures

Under Counter Sinks



Ovalyn™ Large Under Counter Sink

- Under counter mount sink
- Unglazed rim
- Front overflow
- Supplied with mounting kit and template
- Made of vitreous china

Nominal Dimensions:

17-3/8 in x 21-1/2 in (441 mm x 546 mm)

Bowl Size:

19 in (wide) 15-3/8 in (front to back) 5-1/2 in (deep)

Description	Net Wt	SKU	Color	List Price
Ovalyn™ Large Under Counter Sink	23 lb 10.4 kg	0497221.020	White	93
		0497221.021	Bone	255
		0497221.222	Linen	255

Separate Components:

Under Counter Mounting Kit	0 lb 0.1 kg	▷047194-0070A	No Finish	21
----------------------------	----------------	---------------	-----------	----



Ovalyn™ Large Under Counter Sink With Glazed Underside

- Under counter mount sink with glazed underside
- Unglazed rim
- Front overflow
- Supplied with mounting kit and template
- Made of vitreous china

Nominal Dimensions:

17-3/8 in x 21-1/2 in (441 mm x 546 mm)

Bowl Size:

19 in (wide) 15-3/8 in (front to back) 4 in (deep)

Description	Net Wt	SKU	Color	List Price
Ovalyn™ Large Under Counter Sink With Glazed Underside	23 lb 10.4 kg	0497300.020	White	136

Separate Components:

Under Counter Mounting Kit	0 lb 0.1 kg	▷047194-0070A	No Finish	21
----------------------------	----------------	---------------	-----------	----



Ovalyn™ Universal Access Undermount Sink

- Under counter mount sink
- Unglazed rim
- Rear overflow
- Supplied with under counter mounting kit and template
- Made of vitreous china

Nominal Dimensions:

15-3/4 in x 19-1/2 in (400 mm x 495 mm)

Bowl Size:

16-3/4 in (wide) 13-1/4 in (front to back) 4 in (deep)

Description	Net Wt	SKU	Color	List Price
Ovalyn™ Universal Access Undermount Sink	15 lb 6.8 kg	9482000.020	White	126

Separate Components:

Under Counter Mounting Kit	0 lb 0.1 kg	▷047194-0070A	No Finish	21
----------------------------	----------------	---------------	-----------	----

▷ Parts Program

ADA – Countertop 34" (864 mm) from finished floor. Refer to product specification sheet for full details.

Commercial Fixtures

Wall-Hung Sinks



Corner Minette™ Wall-Hung Sink With 4-Inch Centerset

- Wall-hung corner sink
- Front overflow
- Furnished with two wall hangers

Nominal Dimensions:

16-3/4 in x 11 in (425 mm x 279 mm)

Bowl Size:

12-1/4 in (wide) 8-5/8 in (front to back) 5-1/4 in (deep)

Description	Net Wt	SKU	Color	List Price
Corner Minette® Wall-Hung Sink With 4-Inch Centerset	24 lb 11.0 kg	0451021.020	White	387



Corner Minette® Wall-Hung Sink With Center Hole Only

- Wall-hung corner sink
- Front overflow
- Furnished with two wall hangers

Nominal Dimensions:

16-3/4 in x 11 in (425 mm x 279 mm)

Bowl Size:

12-1/4 in (wide) 8-5/8 in (front to back) 5-1/4 in (deep)

Description	Net Wt	SKU	Color	List Price
Corner Minette® Wall-Hung Sink With Center Hole Only	24 lb 11.0 kg	0451001.020	White	387

Commercial Fixtures

Pedestal or Wall-Hung Sinks



Cornice™ 4-Inch Centerset Pedestal Sink Top and Leg Combination

- Corner sink and pedestal
- Corner sink without pedestal can also be wall-hung. Supplied with wall hanger
- Rim slants toward drain for quick drainage
- Twin front concealed overflows
- Made of vitreous china

Nominal Dimensions:

18-7/8 in x 18-7/8 in x 33-3/8 in (479 mm x 479 mm x 847 mm)

Bowl Size:

14 in (wide) 12 in (front to back) 6-1/2 in (deep)

Description	Net Wt	SKU	Color	List Price
Cornice™ 4-Inch Centerset Pedestal Sink Top and Leg Combination		0611400.020	White	473

Separate Components:

Cornice® Pedestal Leg	23 lb 10.7 kg	0028000.020	White	96
Cornice™ 4-Inch Centerset Pedestal Sink Top	32 lb 14.9 kg	0611004.020	White	377



Cornice™ Center Hole Only Pedestal Sink Top and Leg Combination

- Corner sink and pedestal
- Corner sink without pedestal can also be wall-hung. Supplied with wall hanger
- Rim slants toward drain for quick drainage
- Twin front concealed overflows
- Made of vitreous china

Nominal Dimensions:

18-7/8 in x 18-7/8 in x 33-3/8 in (479 mm x 479 mm x 847 mm)

Bowl Size:

14 in (wide) 12 in (front to back) 6-1/2 in (deep)

Description	Net Wt	SKU	Color	List Price
Cornice™ Center Hole Only Pedestal Sink Top and Leg Combination		0611100.020	White	473

Separate Components:

Cornice® Pedestal Leg	23 lb 10.7 kg	0028000.020	White	96
Cornice™ Center Hole Only Pedestal Sink Top	32 lb 14.9 kg	0611001.020	White	377

Commercial Fixtures

ICS* Sink and Selectronic® IC Touchless Faucet



Infection Control Wall-Hung EverClean Sink with Shroud, A-M Drain and A-M P-Trap

- Wall-hung sink
- Deep basin and sloped ledges minimize splashing
- Offset, non-pooling drain with sealed overflow
- Integral side and back splashes
- Removable acrylic shroud with mounting hardware
- Includes offset drain and P-trap with Saniguard™† antimicrobial coating
- Made of vitreous china

Nominal Dimensions:

17 in x 20 in x 26-1/8 in (431 mm x 508 mm x 663 mm)

Bowl Size:

16-1/2 in (wide) 10-1/4 in (front to back) 9-1/4 in (deep)

Description	Net Wt	SKU	Color	List Price
Infection Control Wall-Hung EverClean Sink with Shroud, A-M Drain and A-M P-Trap	53 lb 24.4 kg	9118111.020	White	1,297



Selectronic® IC Touchless Faucet, Battery-Powered, 1.5 gpm/5.7 Lpm Laminar Flow in Base

- Ideal for Healthcare - Laminar flow restrictor in base and plain spout end
- Includes 4-Year CR-P2 lithium battery
- Touchless operation limits the spread of germs for a safer restroom
- Single inlet for cold or tempered water
- Vandal-resistant brass spout with single-hole installation
- Adjustable Range: Detection zone can be adjusted manually or with optional remote control
- Safety Timer: Automatically turns water off after 30 seconds
- Auto Purge: Faucet can be programmed to periodically purge stagnant water
- Fail-Safe Technology: Faucet automatically shuts off upon loss of power or dead battery
- Optional deck plates, thermostatic mixing valve and remote control available (sold separately)

Nominal Dimensions:

6-1/16 in x 2-1/8 in x 9-1/2 in (153 mm x 53 mm x 241 mm)



Description	Net Wt	SKU	Color	List Price
Selectronic® IC Touchless Faucet, Battery-Powered, 1.5 gpm/5.7 Lpm Laminar Flow in Base	6 lb 2.9 kg	6055193.002	Polished Chrome	635

Optional Components:

Selectronic® 4-Inch Deck Plate	0 lb 0.2 kg	605P400.002	Polished Chrome	47
Selectronic® 8-Inch Deck Plate	1 lb 0.7 kg	605P800.002	Polished Chrome	77

* This product will not eliminate the risk of infection, but provides a hygienic environment by reducing splashing through its unique design.

† Saniguard is a registered trademark of Component Hardware Group, Inc.

Commercial Fixtures

ICS* Sink and Selectronic® IC Touchless Faucet



Selectronic® IC Touchless Faucet, Base Model, 1.5 gpm/5.7 Lpm Laminar Flow in Base

- Ideal for Healthcare - Laminar flow restrictor in base and plain spout end
- POWER KIT MUST BE PURCHASED SEPARATELY
- Touchless operation limits the spread of germs for a safer restroom
- Single inlet for cold or tempered water
- Vandal-resistant brass spout with single-hole installation
- Adjustable Range: Detection zone can be adjusted manually or with optional remote control
- Safety Timer: Automatically turns water off after 30 seconds
- Auto Purge: Faucet can be programmed to periodically purge stagnant water
- Fail-Safe Technology: Faucet automatically shuts off upon loss of power or dead battery
- Optional deck plates, thermostatic mixing valve and remote control available (sold separately)

Nominal Dimensions:

6-1/2 in x 2-1/8 in x 9-1/262 in (165 mm x 53 mm x 228 mm)



Description	Net Wt	SKU	Color	List Price
Selectronic® IC Touchless Faucet, Base Model, 1.5 gpm/5.7 Lpm Laminar Flow in Base	6 lb 2.8 kg	605B193.002	Polished Chrome	596

Required Components:

Selectronic® CR-P2 Lithium Power Kit	0 lb 0.2 kg	PK00.CRP	No Finish	42
Selectronic® Hard Wired AC Power Kit	0 lb 0.3 kg	PK00.HAC	No Finish	129
Selectronic® Multi-AC Power Kit	0 lb 0.2 kg	PK00.MAC	No Finish	72
Selectronic® Plug-In AC Power Kit	1 lb 0.7 kg	PK00.PAC	No Finish	94
Selectronic® PWRX® Power Kit	0 lb 0.2 kg	PK00.WRK	No Finish	158

Optional Components:

Selectronic® 4-Inch Deck Plate	0 lb 0.2 kg	605P400.002	Polished Chrome	47
Selectronic® 8-Inch Deck Plate	1 lb 0.7 kg	605P800.002	Polished Chrome	77

Wall-Hung Sinks



Selectronic® Thermostatic Mixing Valve, ASSE 1070 Certified

- Anti-scald protection
- ASSE 1070 certified
- Integral check valves prevent cross-flow
- Modular design attaches directly to Selectronic faucet control box
- 20" long braided flexible hose with 3/8" compression connections

Nominal Dimensions:

3-3/16 in x 5 in x 23-3/8 in (80 mm x 127 mm x 593 mm)



Description	Net Wt	SKU	Color	List Price
Selectronic Thermostatic Mixing Valve, ASSE 1070 Certified	2 lb 1.2 kg	605XTMV1070	No Finish	239

Selectronic® Power Kits.

Commercial Fixtures

Wall-Hung Sinks



Murro® Wall-Hung EverClean® Sink With 4-Inch Centerset

- Wall-hung sink
- For concealed arm (by others) or wall support
- Faucet holes on 4" (102 mm) centers
- EverClean® Antimicrobial Surface inhibits the growth of stain and odor causing bacteria, mold and mildew on the surface
- Rear overflow
- Recessed self-draining deck
- Made of vitreous china
- Optional acrylic (0062000) or vitreous china (0059020EC) shroud
- ADA and TAS compliant

Nominal Dimensions:

20-1/2 in x 21-1/4 in (520 mm x 539 mm)

Bowl Size:

15-1/2 in (wide) 13-1/2 in (front to back) 5 in (deep)

Description	Net Wt	SKU	Color	List Price
Murro™ Wall-Hung EverClean® Sink With 4-Inch Centerset	40 lb 18.3 kg	0954004EC.020	White	244

Optional Components:

Vitreous China Shroud with EverClean® for Wall-Hung Sink	12 lb 5.5 kg	0059020EC.020	White	177
Acrylic Shroud for Murro® and Large Decorum® Wall-Hung Sink	3 lb 1.8 kg	0062000.020	White	168



Murro® Wall-Hung EverClean Sink With 8-Inch Widespread

- Wall-hung sink
- For concealed arm (by others) or wall support
- Faucet holes on 8" (203 mm) centers
- EverClean® Antimicrobial Surface inhibits the growth of stain and odor causing bacteria, mold and mildew on the surface
- Rear overflow
- Recessed self-draining deck
- Made of vitreous china
- Optional acrylic (0062000) or vitreous china (0059020EC) shroud
- ADA and TAS compliant

Nominal Dimensions:

20-1/2 in x 21-1/4 in (520 mm x 539 mm)

Bowl Size:

15-1/2 in (wide) 13-1/2 in (front to back) 5 in (deep)

Description	Net Wt	SKU	Color	List Price
Murro® Wall-Hung EverClean Sink With 8-Inch Widespread	40 lb 18.3 kg	0958008EC.020	White	244

Optional Components:

Vitreous China Shroud with EverClean® for Wall-Hung Sink	12 lb 5.5 kg	0059020EC.020	White	177
Acrylic Shroud for Murro® and Large Decorum® Wall-Hung Sink	3 lb 1.8 kg	0062000.020	White	168

ADA – Top of front rim mounted 34" (864 mm) from finished floor. Refer to product specification sheet for full details.

Commercial Fixtures

Wall-Hung Sinks



Murro® Wall-Hung EverClean® Sink With Center Hole Only

- Wall-hung sink
- For concealed arm (by others) or wall support
- Faucet holes – center hole only
- EverClean® Antimicrobial Surface inhibits the growth of stain and odor causing bacteria, mold and mildew on the surface
- Rear overflow
- Recessed self-draining deck
- Made of vitreous china
- Optional acrylic (0062000) or vitreous china (0059020EC) shroud
- ADA and TAS compliant

Nominal Dimensions:

20-1/2 in x 21-1/4 in (520 mm x 539 mm)

Bowl Size:

15-1/2 in (wide) 13-1/2 in (front to back) 5 in (deep)

Description	Net Wt	SKU	Color	List Price
Murro™ Wall-Hung EverClean® Sink With Center Hole Only	40 lb 18.3 kg	0955001EC.020	White	244

Optional Components:

Vitreous China Shroud with EverClean® for Wall-Hung Sink	12 lb 5.5 kg	0059020EC.020	White	177
Acrylic Shroud for Murro® and Large Decorum® Wall-Hung Sink	3 lb 1.8 kg	0062000.020	White	168



Murro® Wall-Hung EverClean® Sink Less Overflow With 4-Inch Centerset

- Wall-hung sink
- For concealed arm (by others) or wall support
- Faucet holes on 4" (102 mm) centers
- EverClean® Antimicrobial Surface inhibits the growth of stain and odor causing bacteria, mold and mildew on the surface
- Less overflow
- Recessed self-draining deck
- Made of vitreous china
- Optional acrylic (0062000) or vitreous china (0059020EC) shroud
- ADA and TAS compliant

Nominal Dimensions:

20-1/2 in x 21-1/4 in (520 mm x 539 mm)

Bowl Size:

15-1/2 in (wide) 13-1/2 in (front to back) 5 in (deep)



Description	Net Wt	SKU	Color	List Price
Murro™ Wall-Hung EverClean® Sink Less Overflow With 4-Inch Centerset	40 lb 18.3 kg	0954904EC.020	White	308

Optional Components:

Vitreous China Shroud with EverClean® for Wall-Hung Sink	12 lb 5.5 kg	0059020EC.020	White	177
Acrylic Shroud for Murro® and Large Decorum® Wall-Hung Sink	3 lb 1.8 kg	0062000.020	White	168

ADA – Top of front rim mounted 34" (864 mm) from finished floor. Refer to product specification sheet for full details.

Commercial Fixtures

Wall-Hung Sinks



Murro® Wall-Hung EverClean® Sink Less Overflow With 8-Inch Widespread

- Wall-hung sink
- For concealed arm (by others) or wall support
- Faucet holes on 8" (203 mm) centers
- EverClean® Antimicrobial Surface inhibits the growth of stain and odor causing bacteria, mold and mildew on the surface
- Less overflow
- Recessed self-draining deck
- Made of vitreous china
- Optional acrylic (0062000) or vitreous china (0059020EC) shroud
- ADA and TAS compliant

Nominal Dimensions:

20-1/2 in x 21-1/4 in (520 mm x 539 mm)

Bowl Size:

15-1/2 in (wide) 13-1/2 in (front to back) 5 in (deep)



Description	Net Wt	SKU	Color	List Price
Murro™ Wall-Hung EverClean® Sink Less Overflow With 8-Inch Widespread	40 lb 18.3 kg	0958908EC.020	White	308

Optional Components:

Vitreous China Shroud with EverClean® for Wall-Hung Sink	12 lb 5.5 kg	0059020EC.020	White	177
Acrylic Shroud for Murro® and Large Decorum® Wall-Hung Sink	3 lb 1.8 kg	0062000.020	White	168



Murro® Wall-Hung EverClean® Sink Less Overflow With Center Hole Only

- Wall-hung sink
- For concealed arm (by others) or wall support
- Faucet holes – center hole only
- EverClean® Antimicrobial Surface inhibits the growth of stain and odor causing bacteria, mold and mildew on the surface
- Less overflow
- Recessed self-draining deck
- Made of vitreous china
- Optional acrylic (0062000) or vitreous china (0059020EC) shroud
- ADA and TAS compliant

Nominal Dimensions:

20-1/2 in x 21-1/4 in (520 mm x 539 mm)

Bowl Size:

15-1/2 in (wide) 13-1/2 in (front to back) 5 in (deep)



Description	Net Wt	SKU	Color	List Price
Murro™ Wall-Hung EverClean® Sink Less Overflow With Center Hole Only	40 lb 18.3 kg	0955901EC.020	White	308

Optional Components:

Vitreous China Shroud with EverClean® for Wall-Hung Sink	12 lb 5.5 kg	0059020EC.020	White	177
Acrylic Shroud for Murro® and Large Decorum® Wall-Hung Sink	3 lb 1.8 kg	0062000.020	White	168

ADA – Top of front rim mounted 34" (864 mm) from finished floor. Refer to product specification sheet for full details.

Commercial Fixtures

Wall-Hung Sinks



Murro® Wall-Hung EverClean® Sink With 4-Inch Centerset and Extra Right-Hand Hole

- Wall-hung sink
- For concealed arm (by others) or wall support
- Faucet holes on 4" (102 mm) centers
- EverClean® Antimicrobial Surface inhibits the growth of stain and odor causing bacteria, mold and mildew on the surface
- Rear overflow
- Recessed self-draining deck
- Made of vitreous china
- Optional acrylic (0062000) or vitreous china (0059020EC) shroud
- Extra hole measures 1-3/8" (35 mm) diameter
- ADA and TAS compliant

Nominal Dimensions:

20-1/2 in x 21-1/4 in (520 mm x 539 mm)

Bowl Size:

15-1/2 in (wide) 13-1/2 in (front to back) 5 in (deep)



Description	Net Wt	SKU	Color	List Price
Murro® Wall-Hung EverClean® Sink With 4-Inch Centerset and Extra Right-Hand Hole	40 lb 18.3 kg	0954123EC.020	White	308

Optional Components:

Vitreous China Shroud with EverClean® for Wall-Hung Sink	12 lb 5.5 kg	0059020EC.020	White	177
--	-----------------	---------------	-------	-----



Murro® Wall-Hung EverClean® Sink With Center Hole Only and Extra Right-Hand Hole

- Wall-hung sink
- For concealed arm (by others) or wall support
- Faucet holes – center hole only
- EverClean® Antimicrobial Surface inhibits the growth of stain and odor causing bacteria, mold and mildew on the surface
- Rear overflow
- Recessed self-draining deck
- Made of vitreous china
- Optional acrylic (0062000) or vitreous china (0059020EC) shroud
- Extra hole measures 1-3/8" (35 mm) diameter
- ADA and TAS compliant

Nominal Dimensions:

20-1/2 in x 21-1/4 in (520 mm x 539 mm)

Bowl Size:

15-1/2 in (wide) 13-1/2 in (front to back) 5 in (deep)



Description	Net Wt	SKU	Color	List Price
Murro™ Wall-Hung EverClean® Sink With Center Hole Only and Extra Right-Hand Hole	40 lb 18.3 kg	0955123EC.020	White	308

Optional Components:

Vitreous China Shroud with EverClean® for Wall-Hung Sink	12 lb 5.5 kg	0059020EC.020	White	177
Acrylic Shroud for Murro® and Large Decorum® Wall-Hung Sink	3 lb 1.8 kg	0062000.020	White	168

Commercial Fixtures

Wall-Hung Sinks



Murro® Wall-Hung EverClean® Sink With 4-Inch Centerset and Extra Left-Hand Hole

- Wall-hung sink
- For concealed arm (by others) or wall support
- Faucet holes on 4" (102 mm) centers
- EverClean® Antimicrobial Surface inhibits the growth of stain and odor causing bacteria, mold and mildew on the surface
- Rear overflow
- Recessed self-draining deck
- Made of vitreous china
- Optional acrylic (0062000) or vitreous china (0059020EC) shroud
- Extra hole measures 1-3/8" (35 mm) diameter
- ADA and TAS compliant

Nominal Dimensions:

20-1/2 in x 21-1/4 in (520 mm x 539 mm)

Bowl Size:

15-1/2 in (wide) 13-1/2 in (front to back) 5 in (deep)



Description	Net Wt	SKU	Color	List Price
Murro® Wall-Hung EverClean® Sink With 4-Inch Centerset and Extra Left-Hand Hole	40 lb 18.3 kg	0954121EC.020	White	308
Murro™ Wall-Hung EverClean® Sink With 4-Inch Centerset and Extra Right-Hand Hole		0954123EC.020	White	308

Optional Components:

Vitreous China Shroud with EverClean® for Wall-Hung Sink	12 lb 5.5 kg	0059020EC.020	White	177
Acrylic Shroud for Murro® and Large Decorum® Wall-Hung Sink	3 lb 1.8 kg	0062000.020	White	168



Murro® Wall-Hung EverClean® Sink With Center Hole Only and Extra Left-Hand Hole

- Wall-hung sink
- For concealed arm (by others) or wall support
- Faucet holes – center hole only
- EverClean® Antimicrobial Surface inhibits the growth of stain and odor causing bacteria, mold and mildew on the surface
- Rear overflow
- Recessed self-draining deck
- Made of vitreous china
- Optional acrylic (0062000) or vitreous china (0059020EC) shroud
- Extra hole measures 1-3/8" (35 mm) diameter
- ADA and TAS compliant

Nominal Dimensions:

20-1/2 in x 21-1/4 in (520 mm x 539 mm)

Bowl Size:

15-1/2 in (wide) 13-1/2 in (front to back) 5 in (deep)



Description	Net Wt	SKU	Color	List Price
Murro® Wall-Hung EverClean® Sink With Center Hole Only and Extra Left-Hand Hole	40 lb 18.3 kg	0955121EC.020	White	308

Optional Components:

Vitreous China Shroud with EverClean® for Wall-Hung Sink	12 lb 5.5 kg	0059020EC.020	White	177
Acrylic Shroud for Murro® and Large Decorum® Wall-Hung Sink	3 lb 1.8 kg	0062000.020	White	168

ADA – Top of front rim mounted 34" (864 mm) from finished floor. Refer to product specification sheet for full details.

Commercial Fixtures

Wall-Hung Sinks



Acrylic Shroud for Murro® and Large Decorum® Wall-Hung Sink

- Acrylic shroud / knee contact guard
- For use on Murro® and 9134 Decorum® sinks
- Designed to conceal supply lines, p-trap and faucet control box
- Easy to install and remove
- Shroud mounting hardware included
- ADA compliant

Nominal Dimensions:

10-7/16 in x 15-13/16 in x 16-1/8 in (265 mm x 401 mm x 409 mm)

Description	Net Wt	SKU	Color	List Price
Acrylic Shroud for Murro® and Large Decorum® Wall-Hung Sink	3 lb 1.8 kg	0062000.020	White	168



Vitreous China Shroud with EverClean® for Wall-Hung Sink

- Vitreous china shroud / knee contact guard
- For use on Murro™ and 9134 Decorum® sinks
- EverClean® Antimicrobial Surface inhibits the growth of stain and odor causing bacteria, mold and mildew on the surface
- Designed to conceal supply lines and p-trap
- Shroud mounting hardware included
- ADA compliant

Nominal Dimensions:

7-1/2 in x 10-1/2 in (10 in x 190 mm x 266 mm)

Description	Net Wt	SKU	Color	List Price
Vitreous China Shroud with EverClean® for Wall-Hung Sink	12 lb 5.5 kg	0059020EC.020	White	177

Commercial Fixtures

Wall-Hung Sinks



Decorum® Wall-Hung EverClean® Sink With 4-Inch Centerset

- Wall-hung sink
- For concealed arm (by others) or wall support
- Faucet holes on 4" (102 mm) centers
- EverClean® Antimicrobial Surface inhibits the growth of stain and odor causing bacteria, mold and mildew on the surface
- Rear overflow
- Recessed self-draining deck
- ADA and TAS compliant
- Made of vitreous china

Nominal Dimensions:

18-1/4 in x 20 in (463 mm x 508 mm)

Bowl Size:

13-15/16 in (wide) 12-13/16 in (front to back) 5 in (deep)



Description	Net Wt	SKU	Color	List Price
Decorum® Wall-Hung EverClean® Sink With 4-Inch Centerset	32 lb 14.8 kg	9024004EC.020	White	287



Decorum® Wall-Hung EverClean® Sink With 8-Inch Widespread

- Wall-hung sink
- For concealed arm (by others) or wall support
- Faucet holes on 8" (203 mm) centers
- EverClean® Antimicrobial Surface inhibits the growth of stain and odor causing bacteria, mold and mildew on the surface
- Rear overflow
- Recessed self-draining deck
- ADA and TAS compliant
- Made of vitreous china

Nominal Dimensions:

18-1/4 in x 20 in (463 mm x 508 mm)

Bowl Size:

13-15/16 in (wide) 12-13/16 in (front to back) 5 in (deep)



Description	Net Wt	SKU	Color	List Price
Decorum® Wall-Hung EverClean® Sink With 8-Inch Widespread	32 lb 14.8 kg	9024008EC.020	White	287



Decorum® Wall-Hung EverClean® Sink With Center Hole Only

- Wall-hung sink
- For concealed arm (by others) or wall support
- Faucet holes – center hole only
- EverClean® Antimicrobial Surface inhibits the growth of stain and odor causing bacteria, mold and mildew on the surface
- Rear overflow
- Recessed self-draining deck
- ADA and TAS compliant
- Made of vitreous china

Nominal Dimensions:

18-1/4 in x 20 in (463 mm x 508 mm)

Bowl Size:

13-15/16 in (wide) 12-13/16 in (front to back) 5 in (deep)



Description	Net Wt	SKU	Color	List Price
Decorum® Wall-Hung EverClean® Sink With Center Hole Only	32 lb 14.8 kg	9024001EC.020	White	287

ADA – Top of front rim mounted 34" (864 mm) from finished floor. Refer to product specification sheet for full details.

Commercial Fixtures

Wall-Hung Sinks



Decorum® Wall-Hung EverClean® Sink, No Faucet Holes

- Wall-hung sink
- For concealed arm (by others) or wall support
- Less faucet holes
- EverClean® Antimicrobial Surface inhibits the growth of stain and odor causing bacteria, mold and mildew on the surface
- Rear overflow
- Recessed self-draining deck
- ADA and TAS compliant
- Made of vitreous china

Nominal Dimensions:

18-1/4 in x 20 in (463 mm x 508 mm)

Bowl Size:

13-15/16 in (wide) 12-13/16 in (front to back) 5 in (deep)



Description	Net Wt	SKU	Color	List Price
Decorum® Wall-Hung EverClean® Sink, No Faucet Holes	32 lb 14.8 kg	9024000EC.020	White	287



Decorum® Wall-Hung EverClean® Sink Less Overflow With 4-Inch Centerset

- Wall-hung sink
- For concealed arm (by others) or wall support
- Faucet holes on 4" (102 mm) centers
- EverClean® Antimicrobial Surface inhibits the growth of stain and odor causing bacteria, mold and mildew on the surface
- Less overflow
- Recessed self-draining deck
- ADA and TAS compliant
- Made of vitreous china

Nominal Dimensions:

18-1/4 in x 20 in (463 mm x 508 mm)

Bowl Size:

13-15/16 in (wide) 12-13/16 in (front to back) 5 in (deep)



Description	Net Wt	SKU	Color	List Price
Decorum® Wall-Hung EverClean® Sink Less Overflow With 4-Inch Centerset	32 lb 14.8 kg	9024904EC.020	White	357



Decorum® Wall-Hung EverClean® Sink Less Overflow With 8-Inch Centerset

- Wall-hung sink
- For concealed arm (by others) or wall support
- Faucet holes on 8" (203 mm) centers
- EverClean® Antimicrobial Surface inhibits the growth of stain and odor causing bacteria, mold and mildew on the surface
- Less overflow
- Recessed self-draining deck
- ADA and TAS compliant
- Made of vitreous china

Nominal Dimensions:

18-1/4 in x 20 in (463 mm x 508 mm)

Bowl Size:

13-15/16 in (wide) 12-13/16 in (front to back) 5 in (deep)



Description	Net Wt	SKU	Color	List Price
Decorum® Wall-Hung EverClean® Sink Less Overflow With 8-Inch Centerset	32 lb 14.8 kg	9024908EC.020	White	357

ADA – Top of front rim mounted 34" (864 mm) from finished floor. Refer to product specification sheet for full details.

Commercial Fixtures

Wall-Hung Sinks



Decorum® Wall-Hung EverClean® Sink Less Overflow With Center Hole Only

- Wall-hung sink
- For concealed arm (by others) or wall support
- Faucet holes – center hole only
- EverClean® Antimicrobial Surface inhibits the growth of stain and odor causing bacteria, mold and mildew on the surface
- Less overflow
- Recessed self-draining deck
- ADA and TAS compliant
- Made of vitreous china

Nominal Dimensions:

18-1/4 in x 20 in (463 mm x 508 mm)

Bowl Size:

13-15/16 in (wide) 12-13/16 in (front to back) 5 in (deep)



Description	Net Wt	SKU	Color	List Price
Decorum® Wall-Hung EverClean® Sink Less Overflow With Center Hole Only	32 lb 14.8 kg	9024901EC.020	White	357



Decorum® Wall-Hung EverClean® Sink With 4-Inch Centerset and Extra Right-Hand Hole

- Wall-hung sink
- For concealed arm (by others) or wall support
- Faucet holes on 4" (102 mm) centers
- EverClean® Antimicrobial Surface inhibits the growth of stain and odor causing bacteria, mold and mildew on the surface
- Rear overflow
- Recessed self-draining deck
- ADA and TAS compliant
- Made of vitreous china
- Extra hole measures 1-3/8" (35 mm) diameter

Nominal Dimensions:

18-1/4 in x 20 in (463 mm x 508 mm)

Bowl Size:

13-15/16 in (wide) 12-13/16 in (front to back) 5 in (deep)



Description	Net Wt	SKU	Color	List Price
Decorum® Wall-Hung EverClean® Sink With 4-Inch Centerset and Extra Right-Hand Hole	32 lb 14.8 kg	9024014EC.020	White	357



Decorum® Wall-Hung EverClean® Sink With Center Hole Only and Extra Right-Hand Hole

- Wall-hung sink
- For concealed arm (by others) or wall support
- Faucet holes – center hole only
- EverClean® Antimicrobial Surface inhibits the growth of stain and odor causing bacteria, mold and mildew on the surface
- Rear overflow
- Recessed self-draining deck
- ADA and TAS compliant
- Made of vitreous china
- Extra hole measures 1-3/8" (35 mm) diameter

Nominal Dimensions:

18-1/4 in x 20 in (463 mm x 508 mm)

Bowl Size:

13-15/16 in (wide) 12-13/16 in (front to back) 5 in (deep)



Description	Net Wt	SKU	Color	List Price
Decorum® Wall-Hung EverClean® Sink With Center Hole Only and Extra Right-Hand Hole	32 lb 14.8 kg	9024011EC.020	White	357

ADA – Top of front rim mounted 34" (864 mm) from finished floor. Refer to product specification sheet for full details.

Commercial Fixtures

Wall-Hung Sinks



Decorum® Wall-Hung EverClean® Sink With 4-Inch Centerset and Extra Left-Hand Hole

- Wall-hung sink
- For concealed arm (by others) or wall support
- Faucet holes on 4" (102 mm) centers
- EverClean® Antimicrobial Surface inhibits the growth of stain and odor causing bacteria, mold and mildew on the surface
- Rear overflow
- Recessed self-draining deck
- ADA and TAS compliant
- Made of vitreous china
- Extra hole measures 1-3/8" (35 mm) diameter

Nominal Dimensions:

18-1/4 in x 20 in (463 mm x 508 mm)

Bowl Size:

13-15/16 in (wide) 12-13/16 in (front to back) 5 in (deep)



Description	Net Wt	SKU	Color	List Price
Decorum® Wall-Hung EverClean® Sink With 4-Inch Centerset and Extra Left-Hand Hole	32 lb 14.8 kg	9024024EC.020	White	357



Decorum® Wall-Hung EverClean® Sink With Center Hole Only and Extra Left-Hand Hole

- Wall-hung sink
- For concealed arm (by others) or wall support
- Faucet holes – center hole only
- EverClean® Antimicrobial Surface inhibits the growth of stain and odor causing bacteria, mold and mildew on the surface
- Rear overflow
- Recessed self-draining deck
- ADA and TAS compliant
- Made of vitreous china
- Extra hole measures 1-3/8" (35 mm) diameter

Nominal Dimensions:

18-1/4 in x 20 in (463 mm x 508 mm)

Bowl Size:

13-15/16 in (wide) 12-13/16 in (front to back) 5 in (deep)



Description	Net Wt	SKU	Color	List Price
Decorum® Wall-Hung EverClean® Sink With Center Hole Only and Extra Left-Hand Hole	32 lb 14.8 kg	9024021EC.020	White	357



Decorum® Wall-Hung EverClean® Sink Less Overflow With 4-Inch Centerset and Extra Right-Hand Hole

- Wall-hung sink
- For concealed arm (by others) or wall support
- Faucet holes on 4" (102 mm) centers
- EverClean® Antimicrobial Surface inhibits the growth of stain and odor causing bacteria, mold and mildew on the surface
- Less overflow
- Recessed self-draining deck
- ADA and TAS compliant
- Made of vitreous china
- Extra hole measures 1-3/8" (35 mm) diameter

Nominal Dimensions:

18-1/4 in x 20 in (463 mm x 508 mm)

Bowl Size:

13-15/16 in (wide) 12-13/16 in (front to back) 5 in (deep)



Description	Net Wt	SKU	Color	List Price
Decorum® Wall-Hung EverClean® Sink Less Overflow With 4-Inch Centerset and Extra Right-Hand Hole	32 lb 14.8 kg	9024914EC.020	White	384

ADA – Top of front rim mounted 34" (864 mm) from finished floor. Refer to product specification sheet for full details.

Commercial Fixtures

Wall-Hung Sinks



Decorum® Wall-Hung EverClean® Sink Less Overflow With Center Hole Only and Extra Right-Hand Hole

- Wall-hung sink
- For concealed arm (by others) or wall support
- Faucet holes – center hole only
- EverClean® Antimicrobial Surface inhibits the growth of stain and odor causing bacteria, mold and mildew on the surface
- Less overflow
- Recessed self-draining deck
- ADA and TAS compliant
- Made of vitreous china
- Extra hole measures 1-3/8" (35 mm) diameter

Nominal Dimensions:

18-1/4 in x 20 in (463 mm x 508 mm)

Bowl Size:

13-15/16 in (wide) 12-13/16 in (front to back) 5 in (deep)



Description	Net Wt	SKU	Color	List Price
Decorum® Wall-Hung EverClean® Sink Less Overflow With Center Hole Only and Extra Right-Hand Hole	32 lb 14.8 kg	9024921EC.020	White	384



Decorum® Wall-Hung EverClean® Sink Less Overflow with 4-Inch Centerset and Extra Left-Hand Hole

- Wall-hung sink
- For concealed arm (by others) or wall support
- Faucet holes on 4" (102 mm) centers
- EverClean® Antimicrobial Surface inhibits the growth of stain and odor causing bacteria, mold and mildew on the surface
- Less overflow
- Recessed self-draining deck
- ADA and TAS compliant
- Made of vitreous china
- Extra hole measures 1-3/8" (35 mm) diameter

Nominal Dimensions:

18-1/4 in x 20 in (463 mm x 508 mm)

Bowl Size:

13-15/16 in (wide) 12-13/16 in (front to back) 5 in (deep)



Description	Net Wt	SKU	Color	List Price
Decorum® Wall-Hung EverClean® Sink Less Overflow with 4-Inch Centerset and Extra Left-Hand Hole	32 lb 14.8 kg	9024924EC.020	White	384



Decorum® Wall-Hung EverClean® Sink Less Overflow With Center Hole Only and Extra Left-Hand Hole

- Wall-hung sink
- For concealed arm (by others) or wall support
- Faucet holes – center hole only
- EverClean® Antimicrobial Surface inhibits the growth of stain and odor causing bacteria, mold and mildew on the surface
- Less overflow
- Recessed self-draining deck
- ADA and TAS compliant
- Made of vitreous china
- Extra hole measures 1-3/8" (35 mm) diameter

Nominal Dimensions:

18-1/4 in x 20 in (463 mm x 508 mm)

Bowl Size:

13-15/16 in (wide) 12-13/16 in (front to back) 5 in (deep)



Description	Net Wt	SKU	Color	List Price
Decorum® Wall-Hung EverClean® Sink Less Overflow With Center Hole Only and Extra Left-Hand Hole	32 lb 14.8 kg	9024911EC.020	White	384

ADA – Top of front rim mounted 34" (864 mm) from finished floor. Refer to product specification sheet for full details.

Commercial Fixtures

Wall-Hung Sinks



Decorum® 21 x 20-1/4-Inch (533 x 514 mm) Wall-Hung EverClean® Sink With 4-Inch Centerset

- Wall-hung sink
- Made of vitreous china
- EverClean® Antimicrobial Surface inhibits the growth of stain and odor causing bacteria, mold and mildew on the surface
- Faucet holes on 4" (102 mm) centers
- For concealed arm (by others) or wall support (wall hanger included)
- Rear overflow
- Recessed self-draining deck
- Optional acrylic (0062000) or vitreous china (0059020EC) shroud
- ADA and TAS compliant

Nominal Dimensions:

20-1/4 in x 21 in (514 mm x 533 mm)

Bowl Size:

15 in (wide) 14-9/16 in (front to back) 5 in (deep)

Description	Net Wt	SKU	Color	List Price
Decorum® 21 x 20-1/4-Inch (533 x 514 mm) Wall-Hung EverClean® Sink With 4-Inch Centerset	34 lb 15.4 kg	9134004EC.020	White	396

Optional Components:

Vitreous China Shroud with EverClean® for Wall-Hung Sink	12 lb 5.5 kg	0059020EC.020	White	177
Acrylic Shroud for Murro™ and Large Decorum® Wall-Hung Sink	3 lb 1.8 kg	0062000.020	White	168



Decorum® 21 x 20-1/4-Inch (533 x 514 mm) Wall-Hung EverClean® Sink With 8-Inch Widespread

- Wall-hung sink
- Made of vitreous china
- EverClean® Antimicrobial Surface inhibits the growth of stain and odor causing bacteria, mold and mildew on the surface
- Faucet holes on 8" (203 mm) centers
- For concealed arm (by others) or wall support (wall hanger included)
- Rear overflow
- Recessed self-draining deck
- Optional acrylic (0062000) or vitreous china (0059020EC) shroud
- ADA and TAS compliant

Nominal Dimensions:

20-1/4 in x 21 in (514 mm x 533 mm)

Bowl Size:

15 in (wide) 14-9/16 in (front to back) 5 in (deep)



Description	Net Wt	SKU	Color	List Price
Decorum® 21 x 20-1/4-Inch (533 x 514 mm) Wall-Hung EverClean® Sink With 8-Inch Widespread	34 lb 15.4 kg	9134008EC.020	White	396

Optional Components:

Vitreous China Shroud with EverClean® for Wall-Hung Sink	12 lb 5.5 kg	0059020EC.020	White	177
Acrylic Shroud for Murro™ and Large Decorum® Wall-Hung Sink	3 lb 1.8 kg	0062000.020	White	168

ADA – Top of front rim mounted 34" (864 mm) from finished floor. Refer to product specification sheet for full details.

Commercial Fixtures

Wall-Hung Sinks



Decorum® 21 x 20-1/4-Inch (533 x 514 mm) Wall-Hung EverClean® Sink With Center Hole Only

- Wall-hung sink
- Made of vitreous china
- EverClean® Antimicrobial Surface inhibits the growth of stain and odor causing bacteria, mold and mildew on the surface
- Faucet holes – center hole only
- For concealed arm (by others) or wall support (wall hanger included)
- Rear overflow
- Recessed self-draining deck
- Optional acrylic (0062000) or vitreous china (0059020EC) shroud
- ADA and TAS compliant

Nominal Dimensions:

20-1/4 in x 21 in (514 mm x 533 mm)

Bowl Size:

15 in (wide) 14-9/16 in (front to back) 5 in (deep)



Description	Net Wt	SKU	Color	List Price
Decorum® 21 x 20-1/4-Inch (533 x 514 mm) Wall-Hung EverClean® Sink With Center Hole Only	34 lb 15.4 kg	9134001EC.020	White	396

Optional Components:

Vitreous China Shroud with EverClean® for Wall-Hung Sink	12 lb 5.5 kg	0059020EC.020	White	177
Acrylic Shroud for Murro™ and Large Decorum® Wall-Hung Sink	3 lb 1.8 kg	0062000.020	White	168

Wall-Hung Sinks

ADA – Top of front rim mounted 34" (864 mm) from finished floor. Refer to product specification sheet for full details.

Commercial Fixtures

Wall-Hung Sinks



Ravenna® 4-Inch Centerset Wall-Hung Sink and Semi-Pedestal Leg Combination

- Contemporary wall-hung design
- Semi-pedestal P-trap cover for ease of cleaning
- Faucet ledge with generous shelf area for accessories
- Rear overflow
- Available integral mounted towel bar (order separately)
- Supplied with mounting kit
- Made of vitreous china

Nominal Dimensions:

24-1/4 in x 20 in x 34 in (615 mm x 508 mm x 863 mm)

Bowl Size:

19-3/8 in (wide) 12.0 in (front to back) 6 in (deep)



Description	Net Wt	SKU	Color	List Price
Ravenna® 4-Inch Centerset Wall-Hung Sink and Semi-Pedestal Leg Combination		0268444.020	White	438
Separate Components:				
Ravenna® Semi-Pedestal Leg	14 lb 6.4 kg	0044000.020	White	192
Ravenna® 4-Inch Centerset Pedestal Sink Top	41 lb 18.8 kg	0268004.020	White	246
Ravenna® Towel Bar Mounting Kit	0 lb 0.1 kg	▷738520-0070A	No Finish	30
Optional Components:				
Ravenna® Semi-Pedestal Sink Integral Towel Bar	1 lb 0.8 kg	3520000.002	Polished Chrome	91
		3520000.295	Brushed Nickel	112

Wall-Hung Sinks



Ravenna® 8-Inch Widespread Wall-Hung Sink and Semi-Pedestal Leg Combination

- Contemporary wall-hung design
- Semi-pedestal P-trap cover for ease of cleaning
- Faucet ledge with generous shelf area for accessories
- Rear overflow
- Available integral mounted towel bar (order separately)
- Supplied with mounting kit
- Made of vitreous china

Nominal Dimensions:

24-1/4 in x 20 in x 34 in (615 mm x 508 mm x 863 mm)

Bowl Size:

19-3/8 in (wide) 12.0 in (front to back) 6 in (deep)



Description	Net Wt	SKU	Color	List Price
Ravenna® 8-Inch Widespread Wall-Hung Sink and Semi-Pedestal Leg Combination		0268888.020	White	438
Separate Components:				
Ravenna® Semi-Pedestal Leg	14 lb 6.4 kg	0044000.020	White	192
Ravenna® 8-Inch Widespread Pedestal Sink Top	41 lb 18.8 kg	0268008.020	White	246
Ravenna® Towel Bar Mounting Kit	0 lb 0.1 kg	▷738520-0070A	No Finish	30
Optional Components:				
Ravenna® Semi-Pedestal Sink Integral Towel Bar	1 lb 0.8 kg	3520000.002	Polished Chrome	91
		3520000.295	Brushed Nickel	112

▷ Parts Program

Commercial Fixtures

Wall-Hung Sinks



Ravenna® Center Hole Only Wall-Hung Sink and Semi-Pedestal Leg Combination

- Contemporary wall-hung design
- Semi-pedestal P-trap cover for ease of cleaning
- Faucet ledge with generous shelf area for accessories
- Rear overflow
- Available integral mounted towel bar (order separately)
- Supplied with mounting kit
- Made of vitreous china

Nominal Dimensions:

24-1/4 in x 20 in x 34 in (615 mm x 508 mm x 863 mm)

Bowl Size:

19-3/8 in (wide) 12 in (front to back) 6 in (deep)



Description	Net Wt	SKU	Color	List Price
Ravenna® Center Hole Only Wall-Hung Sink and Semi-Pedestal Leg Combination		0268144.020	White	438
Separate Components:				
Ravenna® Semi-Pedestal Leg	14 lb 6.4 kg	0044000.020	White	192
Ravenna® Center Hole Only Pedestal Sink Top	41 lb 18.8 kg	0268001.020	White	246
Ravenna® Towel Bar Mounting Kit	0 lb 0.1 kg	▷738520-0070A	No Finish	30
Optional Components:				
Ravenna® Semi-Pedestal Sink Integral Towel Bar	1 lb 0.8 kg	3520000.002	Polished Chrome	91
		3520000.295	Brushed Nickel	112



Wheelchair Wall-Hung Sink with 4-Inch Centerset

- Wall-hung sink
- For concealed arm (by others)
- Faucet holes on 4" (102 mm) centers
- Front overflow
- Faucet ledge
- Made of vitreous china

Nominal Dimensions:

27 in x 20 in (685 mm x 508 mm)

Bowl Size:

14 in (wide) 14-3/4 in (front to back) 4-3/4 in (deep)



Description	Net Wt	SKU	Color	List Price
Wheelchair Wall-Hung Sink with 4-Inch Centerset	50 lb 22.9 kg	9141011.020	White	536



Wheelchair Wall-Hung Sink With 10-1/2-Inch Widespread

- Wall-hung sink
- For concealed arm (by others)
- Faucet holes on 10-1/2" (267 mm) centers
- Front overflow
- Faucet ledge
- Made of vitreous china

Nominal Dimensions:

27 in x 20 in (685 mm x 508 mm)

Bowl Size:

14 in (wide) 14-3/4 in (front to back) 4-3/4 in (deep)



Description	Net Wt	SKU	Color	List Price
Wheelchair Wall-Hung Sink With 10-1/2-Inch Widespread	50 lb 22.9 kg	9140013.020	White	531

▷ Parts Program

ADA – Top of front rim mounted 34" (864 mm) from finished floor. Refer to product specification sheet for full details.

Commercial Fixtures

Wall-Hung Sinks



Wheelchair Wall-Hung Sink With Center Hole Only

- Wall-hung sink
- For concealed arm (by others)
- Faucet holes – center hole only
- Front overflow
- Faucet ledge
- Made of vitreous china

Nominal Dimensions:

27 in x 20 in (685 mm x 508 mm)

Bowl Size:

14 in (wide) 14-3/4 in (front to back) 4-3/4 in (deep)



Description	Net Wt	SKU	Color	List Price
Wheelchair Wall-Hung Sink With Center Hole Only	50 lb 22.9 kg	9140047.020	White	536



Lucerne™ Wall-Hung Sink With 4-Inch Centerset

- Wall-hung sink
- For wall hanger (included) or concealed arms by others
- Faucet holes on 4" (102 mm) centers
- D-shaped bowl
- Front overflow
- Self-draining deck area with contoured back and side splash shields
- Faucet ledge
- Made of vitreous china

Nominal Dimensions:

18-1/4 in x 21-1/4 in (463 mm x 539 mm)

Bowl Size:

15 in (wide) 10 in (front to back) 6-1/2 in (deep)



Description	Net Wt	SKU	Color	List Price
Lucerne™ Wall-Hung Sink With 4-Inch Centerset	41 lb 19.0 kg	0355012.020	White	101



Lucerne™ Wall-Hung Sink With 8-Inch Widespread

- Wall-hung sink
- For wall hanger (included) or concealed arms by others
- Faucet holes on 8" (203 mm) centers
- D-shaped bowl
- Front overflow
- Self-draining deck area with contoured back and side splash shields
- Faucet ledge
- Made of vitreous china

Nominal Dimensions:

18-1/4 in x 21-1/4 in x 12 in (463 mm x 539 mm x 304 mm)

Bowl Size:

14-7/8 in (wide) 10 in (front to back) 6-1/2 in (deep)



Description	Net Wt	SKU	Color	List Price
Lucerne™ Wall-Hung Sink With 8-Inch Widespread	41 lb 19.0 kg	0356015.020	White	101

ADA – Top of front rim mounted 34" (864 mm) from finished floor. Refer to product specification sheet for full details.

Commercial Fixtures

Wall-Hung Sinks



Lucerne™ Wall-Hung Sink With Single Hole On Right

- Wall-hung sink
- For wall hanger (included) or concealed arms by others
- Single faucet hole on right
- D-shaped bowl
- Front overflow
- Self-draining deck area with contoured back and side splash shields
- Faucet ledge
- Made of vitreous china

Nominal Dimensions:

18-1/4 in x 21-1/4 in x 12 in (463 mm x 539 mm x 304 mm)

Bowl Size:

14-7/8 in (wide) 10 in (front to back) 6-1/2 in (deep)



Description	Net Wt	SKU	Color	List Price
Lucerne™ Wall-Hung Sink With Single Hole On Right	41 lb 19.0 kg	0356439.020	White	181



Lucerne™ Wall-Hung Sink With Center Hole Only

- Wall-hung sink
- For wall hanger (included) or concealed arms by others
- Faucet holes – center hole only
- D-shaped bowl
- Front overflow
- Self-draining deck area with contoured back and side splash shields
- Faucet ledge
- Made of vitreous china

Nominal Dimensions:

18-1/4 in x 21-1/4 in x 12 in (463 mm x 539 mm x 304 mm)

Bowl Size:

14-7/8 in (wide) 10 in (front to back) 6-1/2 in (deep)



Description	Net Wt	SKU	Color	List Price
Lucerne™ Wall-Hung Sink With Center Hole Only	41 lb 19.0 kg	0356421.020	White	101



Lucerne™ Wall-Hung Sink for Exposed Bracket Support With 4-Inch Centerset

- Wall-hung sink
- For exposed bracket support (by others)
- Faucet holes on 4" (102 mm) centers
- D-shaped bowl
- Front overflow
- Self-draining deck area with contoured back and side splash shields
- Faucet ledge
- Made of vitreous china

Nominal Dimensions:

18-1/4 in x 21-1/4 in (463 mm x 539 mm)

Bowl Size:

15 in (wide) 10 in (front to back) 6-1/2 in (deep)



Description	Net Wt	SKU	Color	List Price
Lucerne™ Wall-Hung Sink for Exposed Bracket Support With 4-Inch Centerset	41 lb 19.0 kg	0355027.020	White	111

ADA – Top of front rim mounted 34" (864 mm) from finished floor. Refer to product specification sheet for full details.

Commercial Fixtures

Wall-Hung Sinks



Lucerne™ Wall-Hung Sink for Exposed Bracket Support With 8-Inch Widespread

- Wall-hung sink
- For exposed bracket support (by others)
- Faucet holes on 8" (203 mm) centers
- D-shaped bowl
- Front overflow
- Self-draining deck area with contoured back and side splash shields
- Faucet ledge
- Made of vitreous china

Nominal Dimensions:

18-1/4 in x 21-1/4 in x 12 in (463 mm x 539 mm x 304 mm)

Bowl Size:

14-7/8 in (wide) 10 in (front to back) 6-1/2 in (deep)



Description	Net Wt	SKU	Color	List Price
Lucerne™ Wall-Hung Sink for Exposed Bracket Support With 8-Inch Widespread	41 lb 19.0 kg	0356028.020	White	111



Lucerne™ Wall-Hung Sink for Exposed Bracket Support with Single Hole On Right

- Wall-hung sink
- For exposed bracket support (by others)
- Single faucet hole on right
- D-shaped bowl
- Front overflow
- Self-draining deck area with contoured back and side splash shields
- Faucet ledge
- Made of vitreous china

Nominal Dimensions:

18-1/4 in x 21-1/4 in x 12 in (463 mm x 539 mm x 304 mm)

Bowl Size:

14-7/8 in (wide) 10 in (front to back) 6-1/2 in (deep)



Description	Net Wt	SKU	Color	List Price
Lucerne™ Wall-Hung Sink for Exposed Bracket Support with Single Hole On Right	41 lb 19.0 kg	0356066.020	White	173



Lucerne™ Wall-Hung Sink for Exposed Bracket Support With Center Hole Only

- Wall-hung sink
- For exposed bracket support (by others)
- Faucet holes – center hole only
- D-shaped bowl
- Front overflow
- Self-draining deck area with contoured back and side splash shields
- Faucet ledge
- Made of vitreous china

Nominal Dimensions:

18-1/4 in x 21-1/4 in x 12 in (463 mm x 539 mm x 304 mm)

Bowl Size:

14-7/8 in (wide) 10 in (front to back) 6-1/2 in (deep)



Description	Net Wt	SKU	Color	List Price
Lucerne™ Wall-Hung Sink for Exposed Bracket Support With Center Hole Only	44 lb 20.0 kg	0356041.020	White	101

ADA – Top of front rim mounted 34" (864 mm) from finished floor. Refer to product specification sheet for full details.

Commercial Fixtures

Wall-Hung Sinks



Lucerne™ Wall-Hung Sink Less Overflow With 4-Inch Centerset

- Wall-hung sink
- For wall hanger (included) or concealed arms by others
- Faucet holes on 4" (102 mm) centers
- D-shaped bowl
- Less overflow
- Self-draining deck area with contoured back and side splash shields
- Faucet ledge
- Made of vitreous china

Nominal Dimensions:

18-1/4 in x 21-1/4 in x 12 in (463 mm x 539 mm x 304 mm)

Bowl Size:

14-7/8 in (wide) 10 in (front to back) 6-1/2 in (deep)



Description	Net Wt	SKU	Color	List Price
Lucerne™ Wall-Hung Sink Less Overflow With 4-Inch Centerset	41 lb 19.0 kg	0355912.020	White	239



Lucerne™ Wall-Hung Sink Less Overflow With 8-Inch Widespread

- Wall-hung sink
- For wall hanger (included) or concealed arms by others
- Faucet holes on 8" (203 mm) centers
- D-shaped bowl
- Less overflow
- Self-draining deck area with contoured back and side splash shields
- Faucet ledge
- Made of vitreous china
- Long shank soap/lotion dispenser required (by others)
- Extra hole measures 1-3/8" (35 mm) diameter

Nominal Dimensions:

18-1/4 in x 21-1/4 in x 12 in (463 mm x 539 mm x 304 mm)

Bowl Size:

14-7/8 in (wide) 10 in (front to back) 6-1/2 in (deep)



Description	Net Wt	SKU	Color	List Price
Lucerne™ Wall-Hung Sink Less Overflow With 8-Inch Widespread	41 lb 19.0 kg	0356915.020	White	239



Lucerne™ Wall-Hung Sink Less Overflow With Center Hole Only

- Wall-hung sink
- For wall hanger (included) or concealed arms by others
- Faucet holes – center hole only
- D-shaped bowl
- Less overflow
- Self-draining deck area with contoured back and side splash shields
- Faucet ledge
- Made of vitreous china
- Long shank soap/lotion dispenser required (by others)
- Extra hole measures 1-3/8" (35 mm) diameter

Nominal Dimensions:

18-1/4 in x 21-1/4 in x 12 in (463 mm x 539 mm x 304 mm)

Bowl Size:

14-7/8 in (wide) 10 in (front to back) 6-1/2 in (deep)



Description	Net Wt	SKU	Color	List Price
Lucerne™ Wall-Hung Sink Less Overflow With Center Hole Only	41 lb 19.0 kg	0356921.020	White	239

ADA – Top of front rim mounted 34" (864 mm) from finished floor. Refer to product specification sheet for full details.

Commercial Fixtures

Wall-Hung Sinks



Lucerne™ Wall-Hung Sink With 4-Inch Centerset and Extra Left-Hand Hole

- Wall-hung sink
- For wall hanger (included) or concealed arms by others
- Faucet holes on 4" (102 mm) centers
- D-shaped bowl
- Front overflow
- Self-draining deck area with contoured back and side splash shields
- Faucet ledge
- Made of vitreous china
- Long shank soap/lotion dispenser required (by others)
- Extra hole measures 1-3/8" (35 mm) diameter

Nominal Dimensions:

18-1/4 in x 21-1/4 in x 12 in (463 mm x 539 mm x 304 mm)

Bowl Size:

14-7/8 in (wide) 10 in (front to back) 6-1/2 in (deep)



Description	Net Wt	SKU	Color	List Price
Lucerne™ Wall-Hung Sink With 4-Inch Centerset and Extra Left-Hand Hole	41 lb 19.0 kg	0355056.020	White	135



Lucerne™ Wall-Hung Sink With 4-Inch Centerset and Extra Right-Hand Hole

- Wall-hung sink
- For wall hanger (included) or concealed arms by others
- Faucet holes on 4" (102 mm) centers
- D-shaped bowl
- Front overflow
- Self-draining deck area with contoured back and side splash shields
- Faucet ledge
- Made of vitreous china
- Long shank soap/lotion dispenser required (by others)
- Extra hole measures 1-3/8" (35 mm) diameter

Nominal Dimensions:

18-1/4 in x 21-1/4 in (463 mm x 539 mm)

Bowl Size:

15 in (wide) 10 in (front to back) 6-1/2 in (deep)



Description	Net Wt	SKU	Color	List Price
Lucerne™ Wall-Hung Sink With 4-Inch Centerset and Extra Right-Hand Hole	41 lb 19.0 kg	0355034.020	White	135



Lucerne™ Wall-Hung Sink With 8-Inch Widespread and Extra Right-Hand Hole

- Wall-hung sink
- For wall hanger (included) or concealed arms by others
- Faucet holes on 8" (203 mm) centers
- D-shaped bowl
- Front overflow
- Self-draining deck area with contoured back and side splash shields
- Faucet ledge
- Made of vitreous china
- Long shank soap/lotion dispenser required (by others)
- Extra hole measures 1-3/8" (35 mm) diameter

Nominal Dimensions:

18-1/4 in x 21-1/4 in x 12 in (463 mm x 539 mm x 304 mm)

Bowl Size:

14-7/8 in (wide) 10 in (front to back) 6-1/2 in (deep)



Description	Net Wt	SKU	Color	List Price
Lucerne™ Wall-Hung Sink With 8-Inch Widespread and Extra Right-Hand Hole	43 lb 19.9 kg	0356037.020	White	136

ADA – Top of front rim mounted 34" (864 mm) from finished floor. Refer to product specification sheet for full details.

Commercial Fixtures

Wall-Hung Sinks



Lucerne™ Wall-Hung Sink With Center Hole Only and Extra Left-Hand Hole

- Wall-hung sink
- For wall hanger (included) or concealed arms by others
- Faucet holes – center hole only
- D-shaped bowl
- Front overflow
- Self-draining deck area with contoured back and side splash shields
- Faucet ledge
- Made of vitreous china
- Long shank soap/lotion dispenser required (by others)
- Extra hole measures 1-3/8" (35 mm) diameter

Nominal Dimensions:

18-1/4 in x 21-1/4 in x 12 in (463 mm x 539 mm x 304 mm)

Bowl Size:

14-7/8 in (wide) 10 in (front to back) 6-1/2 in (deep)



Description	Net Wt	SKU	Color	List Price
Lucerne™ Wall-Hung Sink With Center Hole Only and Extra Left-Hand Hole	44 lb 20.0 kg	0356115.020	White	135



Lucerne™ Wall-Hung Sink With Center Hole Only and Extra Right-Hand Hole

- Wall-hung sink
- For wall hanger (included) or concealed arms by others
- Faucet holes – center hole only
- D-shaped bowl
- Front overflow
- Self-draining deck area with contoured back and side splash shields
- Faucet ledge
- Made of vitreous china
- Long shank soap/lotion dispenser required (by others)
- Extra hole measures 1-3/8" (35 mm) diameter

Nominal Dimensions:

18-1/4 in x 21-1/4 in x 12 in (463 mm x 539 mm x 304 mm)

Bowl Size:

14-7/8 in (wide) 10 in (front to back) 6-1/2 in (deep)



Description	Net Wt	SKU	Color	List Price
Lucerne™ Wall-Hung Sink With Center Hole Only and Extra Right-Hand Hole	44 lb 20.0 kg	0356137.020	White	135



Lucerne™ Wall-Hung Sink for Exposed Bracket Support With Center Hole Only

- Wall-hung sink
- For exposed bracket support (by others)
- Faucet holes – center hole only
- D-shaped bowl
- Front overflow
- Self-draining deck area with contoured back and side splash shields
- Faucet ledge
- Made of vitreous china

Nominal Dimensions:

18-1/4 in x 21-1/4 in x 12 in (463 mm x 539 mm x 304 mm)

Bowl Size:

14-7/8 in (wide) 10 in (front to back) 6-1/2 in (deep)



Description	Net Wt	SKU	Color	List Price
Lucerne™ Wall-Hung Sink for Exposed Bracket Support With Center Hole Only	44 lb 20.0 kg	0356041.020	White	101

Wall-Hung Sinks

Commercial Fixtures

Wall-Hung Sinks



Comrade® Wall-Hung Sink With 4-Inch Centerset, Wall Hanger Included

- Wall-hung sink
- Faucet holes on 4" (102 mm) centers
- For wall hanger (included)
- Rear overflow
- Soap depression
- Faucet ledge
- Made of vitreous china

Nominal Dimensions:

18-1/4 in x 20 in (463 mm x 508 mm)

Bowl Size:

15 in (wide) 10-7/8 in (front to back) 6-1/4 in (deep)

Description	Net Wt	SKU	Color	List Price
Comrade® Wall-Hung Sink With 4-Inch Centerset, Wall Hanger Included	40 lb 18.2 kg	0124024.020	White	157



Comrade® Wall-Hung Sink With 4-Inch Centerset, for Concealed Arms

- Wall-hung sink
- Faucet holes on 4" (102 mm) centers
- For concealed arms (by others)
- Rear overflow
- Soap depression
- Faucet ledge
- Made of vitreous china

Nominal Dimensions:

18-1/4 in x 20 in (463 mm x 508 mm)

Bowl Size:

15 in (wide) 10-7/8 in (front to back) 6-1/4 in (deep)

Description	Net Wt	SKU	Color	List Price
Comrade® Wall-Hung Sink With 4-Inch Centerset, for Concealed Arms	40 lb 18.2 kg	0124131.020	White	163



Declyn® Wall-Hung Sink With 4-Inch Centerset, Wall Hanger Included

- Wall-hung sink
- Faucet holes on 4" (102 mm) centers
- For wall hanger (included)
- Rear overflow
- Soap depression
- Faucet ledge
- Made of vitreous china

Nominal Dimensions:

17 in x 18-1/2 in (431 mm x 469 mm)

Bowl Size:

14-1/4 in (wide) 10-3/4 in (front to back) 6 in (deep)

Description	Net Wt	SKU	Color	List Price
Declyn® Wall-Hung Sink With 4-Inch Centerset, Wall Hanger Included	36 lb 16.3 kg	0321026.020	White	93

Commercial Fixtures

Wall-Hung Sinks



Declyn® Wall-Hung Sink With 4-Inch Centerset, for Concealed Arms

- Wall-hung sink
- Faucet holes on 4" (102 mm) centers
- For concealed arms (by others)
- Rear overflow
- Soap depression
- Faucet ledge
- Made of vitreous china

Nominal Dimensions:

17 in x 18-1/2 in (431 mm x 469 mm)

Bowl Size:

14-1/4 in (wide) 10-3/4 in (front to back) 6 in (deep)

Description	Net Wt	SKU	Color	List Price
Declyn® Wall-Hung Sink With 4-Inch Centerset, for Concealed Arms	36 lb 16.3 kg	0321075.020	White	128



Declyn® Wall-Hung Sink Less Overflow with 4-Inch Centerset, for Concealed Arms

- Wall-hung sink
- Faucet holes on 4" (102 mm) centers
- For concealed arms (by others)
- Less overflow
- Soap depression
- Faucet ledge
- Made of vitreous china

Nominal Dimensions:

17 in x 18-1/2 in (431 mm x 469 mm)

Bowl Size:

14-1/4 in (wide) 10-3/4 in (front to back) 6 in (deep)

Description	Net Wt	SKU	Color	List Price
Declyn® Wall-Hung Sink Less Overflow with 4-Inch Centerset, for Concealed Arms	36 lb 16.3 kg	0321975.020	White	119



Regalyn™ Cast Iron Wall-Hung Sink With 4-Inch Centerset

- Enameled cast iron material
- Glossy porcelain finish
- Faucet holes on 4" (102 mm) centers
- Supplied with hanger
- Front overflow

Nominal Dimensions:

18 in x 20 in (457 mm x 508 mm)

Bowl Size:

15-1/2 in (wide) 9-7/8 in (front to back) 6 in (deep)

Description	Net Wt	SKU	Color	List Price
Regalyn™ Cast Iron Wall-Hung Sink With 4-Inch Centerset	72 lb 32.7 kg	4869004.020	White	461

Commercial Fixtures

Wall-Hung Sinks



Regalyn™ Cast Iron Wall-Hung Sink With 8-Inch Widespread

- Enameled cast iron material
- Glossy porcelain finish
- Faucet holes on 8" (203 mm) centers
- Supplied with hanger
- Front overflow

Nominal Dimensions:

18 in x 20 in (457 mm x 508 mm)

Bowl Size:

15-1/2 in (wide) 9-7/8 in (front to back) 6 in (deep)

Description	Net Wt	SKU	Color	List Price
Regalyn™ Cast Iron Wall-Hung Sink With 8-Inch Widespread	73 lb 33.1 kg	4869008.020	White	461



Regalyn™ Cast Iron Wall-Hung Sink With Center Hole Only

- Enameled cast iron material
- Glossy porcelain finish
- Faucet holes – center hole only
- Supplied with hanger
- Front overflow

Nominal Dimensions:

18 in x 20 in (457 mm x 508 mm)

Bowl Size:

15-1/2 in (wide) 9-7/8 in (front to back) 6 in (deep)

Description	Net Wt	SKU	Color	List Price
Regalyn™ Cast Iron Wall-Hung Sink With Center Hole Only	73 lb 33.1 kg	4869001.020	White	462

Commercial Fixtures

Institutional Service Sinks



Floor-Mount Clinic Service Sink

- Flushing rim
- Siphon jet flushing action
- 1-1/2" (38 mm) top spud
- Optional pedestal base
- Optional rim guards
- Made of vitreous china

Nominal Dimensions:

27-3/16 in x 20 in x 17-7/8 in (690 mm x 508 mm x 454 mm)

Description	Net Wt	SKU	Color	List Price
Floor-Mount Clinic Service Sink	76 lb 34.5 kg	9504999.020	White	1,179

Optional Components:

Terrazzo Pedestal Base for Clinic Service Sink, Black on White Finish	175 lb 79.4 kg	710098-201.081	Black On White	583
Stainless Steel Rim Guard for Floor-Mount Clinic Service Sink	0 lb 0.3 kg	7832504.075	Stainless Steel	91



Wall-Hung Clinic Service Sink

- Flushing rim
- Blow-out flushing action
- 1-1/2" (38 mm) top spud
- Optional rim guards
- Made of vitreous china
- Waste outlet piping: 4" (102 mm) preferred, 3" (76 mm) acceptable

Nominal Dimensions:

25-1/4 in x 21-1/8 in x 17-1/2 in (641 mm x 536 mm x 444 mm)

Description	Net Wt	SKU	Color	List Price
Wall-Hung Clinic Service Sink	80 lb 36.3 kg	9512999.020	White	1,116

Optional Components:

Stainless Steel Rim Guard for Floor-Mount Clinic Service Sink	0 lb 0.3 kg	7832504.075	Stainless Steel	91
Stainless Steel Rim Guard (Side) for Floor-Mount Clinic Service Sink		7832512.075	Stainless Steel	91



Florwell® Floor-Mount Cast Iron Service Sink

- Enameled cast iron material
- Glossy porcelain finish
- Sink only, less rim guard

Nominal Dimensions:

28 in x 28 in x 13 in (711 mm x 711 mm x 330 mm)

Description	Net Wt	SKU	Color	List Price
Florwell® Floor-Mount Cast Iron Service Sink	131 lb 59.5 kg	7741000.020	White	1,251

Optional Components:

Grid Strainer Drain for Sinks	3 lb 1.4 kg	7721038.002	Polished Chrome	129
Removable Vinyl Rim Guard for Florwell Service Sink	3 lb 1.6 kg	7745811	No Finish	194

Commercial Fixtures

Institutional Service Sinks



Akron® Wall-Hung Cast Iron Service Sink With Plain Back and Rim Guard

- Enameled cast iron material
- Glossy porcelain finish
- Stainless steel rim guard
- Includes wall hanger
- With plain back

Nominal Dimensions:

20-1/2 in x 24 in x 20-1/4 in (520 mm x 609 mm x 514 mm)

Bowl Size:

19-7/8 in (wide) 16-3/8 in (front to back) 10-1/2 in (deep)

Description	Net Wt	SKU	Color	List Price
Akron® Wall-Hung Cast Iron Service Sink With Plain Back and Rim Guard	98 lb 44.9 kg	7695000.020	White	1,127



Akron® Wall-Hung Cast Iron Service Sink With 8-inch Faucet Holes and Rim Guard

- Enameled cast iron material
- Glossy porcelain finish
- Stainless steel rim guard
- Includes wall hanger
- With drilled back two holes on 8" (203 mm) centers

Nominal Dimensions:

20-1/2 in x 24 in x 20-1/4 in (520 mm x 609 mm x 514 mm)

Bowl Size:

19-7/8 in (wide) 16-3/8 in (front to back) 10-1/2 in (deep)

Description	Net Wt	SKU	Color	List Price
Akron® Wall-Hung Cast Iron Service Sink With 8-inch Faucet Holes and Rim Guard	98 lb 44.9 kg	7695008.020	White	1,127



Lakewell™ Wall-Hung Cast Iron Service Sink With Plain Back and Rim Guard

- Enameled cast iron material
- Glossy porcelain finish
- Stainless steel rim guard
- Includes wall hanger
- With plain back

Nominal Dimensions:

18 in x 22 in x 20-1/4 in (457 mm x 558 mm x 514 mm)

Bowl Size:

18-1/2 in (wide) 14-1/8 in (front to back) 10-1/2 in (deep)

Description	Net Wt	SKU	Color	List Price
Lakewell™ Wall-Hung Cast Iron Service Sink With Plain Back and Rim Guard	89 lb 40.4 kg	7692000.020	White	1,025



Lakewell™ Wall-Hung Cast Iron Service Sink With 8-inch Faucet Holes and Rim Guard

- Enameled cast iron material
- Glossy porcelain finish
- Stainless steel rim guard
- Includes wall hanger
- With drilled back two holes on 8" (203 mm) centers

Nominal Dimensions:

18 in x 22 in x 20-1/4 in (457 mm x 558 mm x 514 mm)

Bowl Size:

18-1/2 in (wide) 14-1/8 in (front to back) 10-1/2 in (deep)

Description	Net Wt	SKU	Color	List Price
Lakewell™ Wall-Hung Cast Iron Service Sink With 8-inch Faucet Holes and Rim Guard	89 lb 40.4 kg	7692008.020	White	1,025

Commercial Fixtures

Institutional Sink Traps



2" Trap Standard for Wall-Hung Cast Iron Service Sink

- 2" Threaded Inside
- P-trap with strainer
- Outlet to wall
- Cast iron pipes are black

Nominal Dimensions:

10 in x 6 in x 15 in (254 mm x 152 mm x 381 mm)

Description	Net Wt	SKU	Color	List Price
2" Trap Standard for Wall-Hung Cast Iron Service Sink	23 lb 10.4 kg	7798020	No Finish	294



3" Trap Standard for Wall-Hung Cast Iron Service Sink

- 3" Threaded Inside
- P-trap with strainer
- Outlet to wall
- Cast iron pipes are black

Nominal Dimensions:

10 in x 6 in x 15 in (254 mm x 152 mm x 381 mm)

Description	Net Wt	SKU	Color	List Price
3" Trap Standard for Wall-Hung Cast Iron Service Sink	23 lb 10.4 kg	7798030	No Finish	294

Commercial Fixtures

High Efficiency (1.28 gpf/4.8 Lpf) Toilets



Baby Devoro™ Two-Piece 1.28 gpf/4.8 Lpf 10-1/4-Inch Height Elongated Toilet

- Combination bowl and tank, less seat
- 10-1/4" (260 mm) rim height
- High efficiency toilet (HET) 1.28 gpf/4.8 Lpf
- 10" (254 mm) rough-in
- Siphon flush action
- 10" x 9" (254 x 229 mm) water surface area
- Color-matched trip lever
- 2-1/8" (54 mm) fully glazed trapway - 2" (51 mm) minimum ballpass
- MaP score of 500 grams at 1.28 gpf/4.8 Lpf

Nominal Dimensions:

25 in x 17-1/4 in x 24 in (635 mm x 438 mm x 609 mm)



Description	Net Wt	SKU	Color	List Price
Baby Devoro™ Two-Piece 1.28 gpf/4.8 Lpf 10-1/4-Inch Height Elongated Toilet		2315228.020	White	346

Separate Components:

Baby Devoro™ 10-1/4-Inch Height Elongated Bowl	31 lb 14.4 kg	3128001.020	White	173
Baby Devoro™ 1.28 gpf/4.8 Lpf 10-Inch Rough Left-Hand Trip Lever Tank	25 lb 11.4 kg	4019228.020	White	173
Left-Hand Trip Lever	0 lb 0.0 kg	▷738903-0020A	Polished Chrome	25
		▷738903-0200A	White	41

Optional Components:

Baby Devoro™ 1.28 gpf/4.8 Lpf 10-Inch Rough Left-Hand Trip Lever Tank With Tank Cover Locking Device	25 lb 11.4 kg	4019613.020	White	198
Commercial Open Front Toilet Seat for Baby Devoro Toilet Bowls	2 lb 1.2 kg	5001G055.020	White	47
Baby Devoro™ 1.28 gpf/4.8 Lpf 10-Inch Rough Right-Hand Trip Lever Tank	25 lb 11.4 kg	4019828.020	White	183

Toilets



Baby Devoro™ 1.28 gpf/4.8 Lpf 10-1/4-Inch Height Top Spud Elongated Bowl

- High efficiency, low consumption (1.28 gpf/4.8 Lpf)
- Siphon jet bowl for flush valve
- 10-1/4" (260 mm) high bowl, less seat
- 10" (254 mm) rough-in
- 1-1/2" (38 mm) top inlet
- 2" (51 mm) fully glazed trapway
- 10" x 12" (254 x 305 mm) water surface area
- Two color-matched bolt caps
- MaP score of 800 grams at 1.28 gpf/4.8 Lpf

Nominal Dimensions:

23-1/2 in x 15-9/16 in x 11-1/8 in (596 mm x 395 mm x 282 mm)



Description	Net Wt	SKU	Color	List Price
Baby Devoro™ 1.28 gpf/4.8 Lpf 10-1/4-Inch Height Top Spud Elongated Bowl	31 lb 14.4 kg	2282001.020	White	241

Separate Components:

1-1/2-Inch Toilet Spud	0 lb 0.3 kg	▷047007-0070A	No Finish	25
------------------------	----------------	---------------	-----------	----

Optional Components:

Commercial Open Front Toilet Seat for Baby Devoro Toilet Bowls	2 lb 1.2 kg	5001G055.020	White	47
--	----------------	--------------	-------	----

▷ Parts Program (Non-Premier)

Meets all ANSI/ASME Low Consumption, Water Conservation Requirements.

Commercial Fixtures

High Efficiency Toilet Operates in the Range of 1.28 – 1.6 gpf (4.8 – 6.0 Lpf)



Madera™ Youth 1.28 – 1.6 gpf (4.8 – 6.0 Lpf) 14-inch Height Top Spud Elongated Bowl

- Floor-mount, elongated flushometer bowl, less seat
- High Efficiency Toilet (HET) operates in the range of 1.28 gpf – 1.6 gpf (4.8 Lpf – 6.0 Lpf)
- Maximum Performance (MaP) score of 800 grams at 1.28 - 1.6 gpf
- ADA and TAS compliant 14" (356 mm) rim height for elementary school children, 5 - 8 years old
- 2-1/8" (54 mm) fully-glazed trapway
- 10" (254 mm) or 12" (305 mm) rough-in
- Condensation channel
- Powerful direct-fed siphon jet action
- 1-1/2" (38 mm) inlet spud

Nominal Dimensions:

27-1/4 in x 14 in x 14-3/16 in (692 mm x 355 mm x 360 mm)

Description	Net Wt	SKU	Color	List Price
Madera™ Youth 1.28 – 1.6 gpf (4.8 – 6.0 Lpf) 14-inch Height Top Spud Elongated Bowl	50 lb 22.8 kg	2599001.020	White	193

Separate Components:

1-1/2-Inch Toilet Spud	0 lb 0.3 kg	▷047007-0070A	No Finish	25
------------------------	----------------	---------------	-----------	----

Optional Components:

Commercial Heavy Duty Open Front Elongated Toilet Seat Wth EverClean® Surface	2 lb 1.3 kg	5901110T.020	White	43
---	----------------	--------------	-------	----

▷ Parts Program (Non-Premier)

Other seat options

Meets all ANSI/ASME Low Consumption, Water Conservation Requirements.

Commercial Fixtures

High Efficiency Toilets Operate in the Range of 1.1 – 1.6 gpf (4.2 – 6.0 Lpf)



Madera™ 16-1/2" (419 mm) Chair Height EverClean® Bowl Less Seat

- Floor-mount, elongated flushometer bowl, less seat
- High Efficiency Toilet (HET) operates in the range of 1.1 gpf – 1.6 gpf (4.2 Lpf – 6.0 Lpf)
- Maximum Performance (MaP) score of 1,000 grams at 1.1 – 1.6 gpf
- EverClean® Antimicrobial Surface inhibits the growth of stain and odor causing bacteria, mold and mildew on the surface
- 16-1/2" (419 mm) Chair Height for accessible applications
- Static weight load of 2,500 lbs (1,134 kg)
- 2-1/8" (54 mm) fully-glazed trapway
- Condensation channel
- Powerful direct-fed siphon jet action
- 1-1/2" (38 mm) inlet spud

Nominal Dimensions:

27-1/4 in x 14 in x 16-7/8 in (692 mm x 355 mm x 428 mm)



Description	Net Wt	SKU	Color	List Price
Madera™ 1.1 – 1.6 gpf (4.2 – 6.0 Lpf) Chair Height Top Spud Elongated EverClean® Bowl	55 lb 25.0 kg	3461001.020	White	222
Madera™ 1.1 – 1.6 gpf (4.2 – 6.0 Lpf) Chair Height Top Spud Elongated EverClean® Bowl With Bedpan Lugs		3462001.020	White	248
Madera™ 1.1 – 1.6 gpf (4.2 – 6.0 Lpf) Chair Height Back Spud Elongated EverClean® Bowl	59 lb 26.8 kg	3463001.020	White	383
Madera™ 1.1 – 1.6 gpf (4.2 – 6.0 Lpf) Chair Height Back Spud Elongated EverClean® Bowl With Bedpan Lugs		3464001.020	White	450
Madera™ 1.1 – 1.6 gpf (4.2 – 6.0 Lpf) Chair Height Top Spud Elongated EverClean® Bowl With 4 Anchoring Holes	57 lb 25.9 kg	3465001.020	White	400
Madera™ 1.1 – 1.6 gpf (4.2 – 6.0 Lpf) Chair Height Top Spud Elongated EverClean® Bowl With Bedpan Lugs, 4 Anchoring Holes		3466001.020	White	433

Separate Components:

1-1/2-Inch Toilet Spud	0 lb 0.3 kg	▷047007-0070A	No Finish	25
------------------------	----------------	---------------	-----------	----

Optional Components:

Commercial Heavy Duty Open Front Elongated Toilet Seat	3 lb 1.4 kg	5901100.020	White	34
Commercial Heavy Duty Open Front Elongated Toilet Seat With EverClean® Surface	2 lb 1.3 kg	5901110T.020	White	43

▷ Parts Program

Other seat options

ADA when installed with provided seat, top of seat is 17" to 19" (432 to 483 mm) from the finished floor.

Meets all ANSI/ASME Low Consumption, Water Conservation Requirements.

High Efficiency Toilet (HET) utilizes 20% less water than traditional 1.6 gpf/6.0 Lpf toilets at 1.28 gpf (4.8 Lpf) and 31% less water at 1.2 gpf (4.2 Lpf).

Commercial Fixtures

High Efficiency Toilets Operate in the Range of 1.1 – 1.6 gpf (4.2 – 6.0 Lpf)



Madera™ 15" (381 mm) Height EverClean® Bowl Less Seat

- Floor-mount, elongated flushometer bowl, less seat
- High Efficiency Toilet (HET) operates in the range of 1.1 gpf – 1.6 gpf (4.2 Lpf – 6.0 Lpf)
- Maximum Performance (MaP) score of 1,000 grams at 1.1 – 1.6 gpf
- EverClean® Antimicrobial Surface inhibits the growth of stain and odor causing bacteria, mold and mildew on the surface
- Standard 15" (381 mm) rim height
- 2-1/8" (54 mm) fully-glazed trapway
- 10" (254 mm) or 12" (305 mm) rough-in
- Condensation channel
- Powerful direct-fed siphon jet action
- 1-1/2" (38 mm) inlet spud

Nominal Dimensions:

27-1/4 in x 14 in x 15-3/8 in (692 mm x 355 mm x 390 mm)

Description	Net Wt	SKU	Color	List Price
Madera™ 1.1 – 1.6 gpf (4.2 – 6.0 Lpf) 15" Height Top Spud Elongated EverClean® Bowl	50 lb 22.8 kg	3451001.020	White	186
Madera™ 1.1 – 1.6 gpf (4.2 – 6.0 Lpf) 15" Height Top Spud Elongated EverClean® Bowl With Bedpan Lugs		3452001.020	White	217
Madera™ 1.1 – 1.6 gpf (4.2 – 6.0 Lpf) 15" Height Back Spud Elongated EverClean® Bowl	58 lb 26.3 kg	3453001.020	White	320
Madera™ 1.1 – 1.6 gpf (4.2 – 6.0 Lpf) 15" Height Back Spud Elongated EverClean® Bowl With Bedpan Lugs	53 lb 24.1 kg	3455001.020	White	383
Separate Components:				
1-1/2-Inch Toilet Spud	0 lb 0.3 kg	▶047007-0070A	No Finish	25
Optional Components:				
Commercial Heavy Duty Open Front Elongated Toilet Seat	3 lb 1.4 kg	5901100.020	White	34
Commercial Heavy Duty Open Front Elongated Toilet Seat With EverClean® Surface	2 lb 1.3 kg	5901110T.020	White	43

▶ Parts Program

Other seat options

ADA when installed with provided seat, top of seat is 17" to 19" (432 to 483 mm) from the finished floor.

Meets all ANSI/ASME Low Consumption, Water Conservation Requirements.

High Efficiency Toilet (HET) utilizes 20% less water than traditional 1.6 gpf/6.0 Lpf toilets at 1.28 gpf (4.8 Lpf) and 31% less water at 1.2 gpf (4.2 Lpf).

Commercial Fixtures

High Efficiency Toilets Operate in the Range of 1.1 – 1.6 gpf (4.2 – 6.0 Lpf)



Madera™ 16-1/2" (419 mm) Chair Height Bowl Less Seat

- Floor-mount, elongated flushometer bowl, less seat
- High Efficiency Toilet (HET) operates in the range of 1.1 gpf – 1.6 gpf (4.2 Lpf – 6.0 Lpf)
- Maximum Performance (MaP) score of 1,000 grams at 1.1 – 1.6 gpf
- 16-1/2" (419 mm) Chair Height for accessible applications
- Static weight load of 2,500 lbs (1,134 kg)
- 2-1/8" (54 mm) fully-glazed trapway
- 10" (254 mm) or 12" (305 mm) rough-in
- Condensation channel
- Powerful direct-fed siphon jet action
- 1-1/2" (38 mm) inlet spud

Nominal Dimensions:

27-1/4 in x 14 in x 16-7/8 in (692 mm x 355 mm x 428 mm)



Description	Net Wt	SKU	Color	List Price
Madera™ 1.1 – 1.6 gpf (4.2 – 6.0 Lpf) Chair Height Top Spud Elongated Bowl	55 lb 25.0 kg	3043001.020	White	180
Madera™ 1.1 – 1.6 gpf (4.2 – 6.0 Lpf) Chair Height Top Spud Elongated Bowl With Bedpan Lugs		3248001.020	White	220
Madera™ 1.1 – 1.6 gpf (4.2 – 6.0 Lpf) Chair Height Back Spud Elongated Bowl	59 lb 26.8 kg	3249001.020	White	217
Separate Components:				
1-1/2-Inch Toilet Spud	0 lb 0.3 kg	▷047007-0070A	No Finish	25
Optional Components:				
Commercial Heavy Duty Open Front Elongated Toilet Seat	3 lb 1.4 kg	5901100.020	White	34
Commercial Heavy Duty Open Front Elongated Toilet Seat With EverClean® Surface	2 lb 1.3 kg	5901110T.020	White	43

▷ Parts Program

Other seat options

ADA when installed with provided seat, top of seat is 17" to 19" (432 to 483 mm) from the finished floor.

Meets all ANSI/ASME Low Consumption, Water Conservation Requirements.

High Efficiency Toilet (HET) utilizes 20% less water than traditional 1.6 gpf/6.0 Lpf toilets at 1.28 gpf (4.8 Lpf) and 31% less water at 1.2 gpf (4.2 Lpf).

Commercial Fixtures

High Efficiency Toilets Operate in the Range of 1.1 – 1.6 gpf (4.2 – 6.0 Lpf)



Madera™ 15" (381 mm) Height Bowl Less Seat

- Floor-mount, elongated flushometer bowl, less seat
- High Efficiency Toilet (HET) operates in the range of 1.1 gpf – 1.6 gpf (4.2 Lpf – 6.0 Lpf)
- Maximum Performance (MaP) score of 1,000 grams at 1.1 – 1.6 gpf
- Standard 15" (381 mm) rim height
- 2-1/8" (54 mm) fully-glazed trapway
- 10" (254 mm) or 12" (305 mm) rough-in
- Condensation channel
- Powerful direct-fed siphon jet action
- 1-1/2" (38 mm) inlet spud

Nominal Dimensions:

27-1/4 in x 14 in x 15-3/8 in (692 mm x 355 mm x 390 mm)

Description	Net Wt	SKU	Color	List Price
Madera™ 1.1 – 1.6 gpf (4.2 – 6.0 Lpf) 15" Height Top Spud Elongated Bowl	58 lb 26.3 kg	2234001.020	White	146
Madera™ 1.1 – 1.6 gpf (4.2 – 6.0 Lpf) 15" Height Top Spud Elongated Bowl With Bedpan Lugs	43 lb 19.5 kg	2623001.020	White	190
Madera™ 1.1 – 1.6 gpf (4.2 – 6.0 Lpf) 15" Height Back Spud Elongated Bowl		2624001.020	White	180

Separate Components:

1-1/2-Inch Toilet Spud	0 lb 0.3 kg	▶047007-0070A	No Finish	25
------------------------	----------------	---------------	-----------	----

Optional Components:

Commercial Heavy Duty Open Front Elongated Toilet Seat	3 lb 1.4 kg	5901100.020	White	34
Commercial Heavy Duty Open Front Elongated Toilet Seat With EverClean® Surface	2 lb 1.3 kg	5901110T.020	White	43

▶ Parts Program

Other seat options

ADA when installed with provided seat, top of seat is 17" to 19" (432 to 483 mm) from the finished floor.

Meets all ANSI/ASME Low Consumption, Water Conservation Requirements.

High Efficiency Toilet (HET) utilizes 20% less water than traditional 1.6 gpf/6.0 Lpf toilets at 1.28 gpf (4.8 Lpf) and 31% less water at 1.2 gpf (4.2 Lpf).

Commercial Fixtures

High Efficiency Toilet Operates in the Range of 1.28 – 1.6 gpf (4.8 – 6.0 Lpf)



Right Width® 1.28 – 1.6 gpf (4.8 – 6.0 Lpf) Chair Height Top Spud Elongated Bowl With Seat

- Floor-mount, elongated flushometer bowl, less seat
- High efficiency, low consumption operates in the range of 1.28 gpf to 1.6 gpf (4.8Lpf to 6.0Lpf)
- 16-½" (419mm) Chair Height for accessible applications
- Static weight load of 2,000 lbs (908kg)
- Extra large footprint ideal for remodeling
- Large water surface area
- 10" (254mm) or 12" (305mm) rough-in
- 2" (51mm) fully glazed trapway
- Includes seat
- Includes color-matched bolt caps

Nominal Dimensions:

28-3/8 in x 16-15/16 in x 16-1/2 in (720 mm x 430 mm x 419 mm)



Description	Net Wt	SKU	Color	List Price
Right Width® 1.28 – 1.6 gpf (4.8 – 6.0 Lpf) Chair Height Top Spud Elongated Bowl With Seat	57 lb 25.9 kg	3641001.020	White	513

Optional Components:

Right Width Open Front Elongated Toilet Seat	5 lb 2.3 kg	5309110.020	White	97
--	----------------	-------------	-------	----

ADA when installed with provided seat, top of seat is 17" to 19" (432 to 483 mm) from the finished floor

Meets all ANSI/ASME Low Consumption, Water Conservation Requirements.

High Efficiency Toilet (HET) utilizes 20% less water than traditional 1.6 gpf/6.0 Lpf toilets at 1.28 gpf (4.8 Lpf) and 31% less water at 1.2 gpf (4.2 Lpf).

Commercial Fixtures

High Efficiency Toilets Operate in the Range of 1.1 – 1.6 gpf (4.2 – 6.0 Lpf)



Afwall® Millennium® Wall-Hung EverClean® Bowl Less Seat

- Wall-hung elongated flushometer bowl, less seat
- High Efficiency Toilet (HET) operates in the range of 1.1gpf – 1.6 gpf (4.2 Lpf – 6.0 Lpf)
- Maximum Performance (MaP) score of 1,000 grams at 1.1 - 1.6 gpf
- EverClean® Antimicrobial Surface inhibits the growth of stain and odor causing bacteria, mold and mildew on the surface
- Direct-fed siphon jet flush action
- 2-1/8" (54 mm) fully-glazed trapway – 2" (51 mm) minimum ballpass
- Static weight load of 1,000 lbs (453 kg). Not recommended for bariatric use
- Concealed trapway design with condensation channel
- 1-1/2" (38 mm) inlet spud

Nominal Dimensions:

26 in x 14 in x 13-1/2 in (660 mm x 355 mm x 342 mm)



Description	Net Wt	SKU	Color	List Price
Afwall® Millennium® 1.1 – 1.6 gpf (4.2 – 6.0 Lpf) Top Spud Elongated Wall-Hung EverClean® Bowl	52 lb 23.6 kg	3351101.020	White	185
Afwall® Millennium® 1.1 – 1.6 gpf (4.2 – 6.0 Lpf) Top Spud Elongated Wall-Hung EverClean® Bowl With Bedpan Lugs		3352101.020	White	211
Afwall® Millennium® 1.1 – 1.6 gpf (4.2 – 6.0 Lpf) Back Spud Elongated Wall-Hung EverClean® Bowl	53 lb 24.2 kg	3353101.020	White	216
Afwall® Millennium® 1.1 – 1.6 gpf (4.2 – 6.0 Lpf) Back Spud Elongated Wall-Hung EverClean® Bowl With Bedpan Lugs		3354101.020	White	391
Separate Components:				
1-1/2-Inch Toilet Spud	0 lb 0.3 kg	▷047007-0070A	No Finish	25
Retro-Fit Bolt Caps	0 lb 0.2 kg	▷7381285-200.0070A	No Finish	56
Optional Components:				
Commercial Heavy Duty Open Front Elongated Toilet Seat	3 lb 1.4 kg	5901100.020	White	34
Commercial Heavy Duty Open Front Elongated Toilet Seat Wth EverClean® Surface	2 lb 1.3 kg	5901110T.020	White	43

▷ Parts Program

Other seat options

ADA when installed with provided seat, top of seat is 17" to 19" (432 to 483 mm) from the finished floor.

Meets all ANSI/ASME Low Consumption, Water Conservation Requirements.

High Efficiency Toilet (HET) utilizes 20% less water than traditional 1.6 gpf/6.0 Lpf toilets at 1.28 gpf (4.8 Lpf) and 31% less water at 1.2 gpf (4.2 Lpf).

Commercial Fixtures

High Efficiency Toilets Operate in the Range of 1.1 – 1.6 gpf (4.2 – 6.0 Lpf)



Afwall® Millennium® Wall-Hung Bowl Less Seat

- Wall-hung elongated flushometer bowl, less seat
- High Efficiency Toilet (HET) operates in the range of 1.1 gpf – 1.6 gpf (4.2 Lpf – 6.0 Lpf)
- Maximum Performance (MaP) score of 1,000 grams at 1.1 – 1.6 gpf
- Conventional glaze
- Direct-fed siphon jet flush action
- 2-1/8" (54 mm) fully-glazed trapway – 2" (51 mm) minimum ballpass
- Static weight load of 1,000 lbs (453 kg). Not recommended for bariatric use
- Concealed trapway design with condensation channel
- 1-1/2" (38 mm) inlet spud

Nominal Dimensions:

26 in x 14 in x 13-1/2 in (660 mm x 355 mm x 342 mm)



Description	Net Wt	SKU	Color	List Price
Afwall® Millennium® 1.1 – 1.6 gpf (4.2 – 6.0 Lpf) Top Spud Elongated Wall-Hung Bowl	52 lb 23.6 kg	2257101.020	White	146
Afwall® Millennium® 1.1 – 1.6 gpf (4.2 – 6.0 Lpf) Top Spud Elongated Wall-Hung Bowl With BedPan Lugs		2633101.020	White	197
Afwall® Millennium® 1.1 – 1.6 gpf (4.2 – 6.0 Lpf) Back Spud Elongated Wall-Hung Bowl	53 lb 24.2 kg	2634101.020	White	199

Separate Components:

1-1/2-Inch Toilet Spud	0 lb 0.3 kg	▷047007-0070A	No Finish	25
Retro-Fit Bolt Caps	0 lb 0.2 kg	▷7381285-200.0070A	No Finish	56

Optional Components:

Commercial Heavy Duty Open Front Elongated Toilet Seat	3 lb 1.4 kg	5901100.020	White	34
Commercial Heavy Duty Open Front Elongated Toilet Seat With EverClean® Surface	2 lb 1.3 kg	5901110T.020	White	43

▷ Parts Program

Other seat options

ADA when installed with provided seat, top of seat is 17" to 19" (432 to 483 mm) from the finished floor.

Meets all ANSI/ASME Low Consumption, Water Conservation Requirements.

High Efficiency Toilet (HET) utilizes 20% less water than traditional 1.6 gpf/6.0 Lpf toilets at 1.28 gpf (4.8 Lpf) and 31% less water at 1.2 gpf (4.2 Lpf).

Commercial Fixtures

High Efficiency Toilets Operate in the Range of 1.28 – 1.6 gpf (4.8 – 6.0 Lpf)



Afwall® ADA Retrofit Wall-Hung EverClean® Bowl Less Seat

- Afwall® ADA replaces standard wall-hung 3.5 or 1.6 models and rough-ins at 16-1/8" (410 mm) rim height to meet ADA with no need to modify the existing carrier or through-wall supply – providing centerline of current outlet is 5-1/4" (133 mm) above finished floor
- Wall-hung elongated flushometer bowl, less seat
- High Efficiency Toilet (HET) operates in the range of 1.28 gpf – 1.6 gpf (4.8 Lpf – 6.0 Lpf)
- EverClean® Antimicrobial Surface inhibits the growth of stain and odor causing bacteria, mold and mildew on the surface
- Condensation channel
- Powerful direct-fed siphon jet flush action
- 2-1/8" (54 mm) fully-glazed trapway
- 1-1/2" (38 mm) inlet spud
- Includes flush valve rough-in adapter kit

Nominal Dimensions:

25 in x 14-3/4 in x 14-1/2 in (635 mm x 374 mm x 368 mm)



Description	Net Wt	SKU	Color	List Price
Afwall® ADA Retrofit 1.28 – 1.6 gpf (4.8 – 6.0 Lpf) Top Spud Elongated Wall-Hung EverClean® Bowl	50 lb 23.0 kg	2294011EC.020	White	498
Afwall® ADA Retrofit 1.28 – 1.6 gpf (4.8 – 6.0 Lpf) Top Spud Elongated Wall-Hung EverClean® Bowl With Bedpan Lugs		2296019EC.020	White	530

Separate Components:

1-1/2-Inch Toilet Spud	0 lb 0.3 kg	▷047007-0070A	No Finish	25
------------------------	----------------	---------------	-----------	----

Optional Components:

Commercial Heavy Duty Open Front Elongated Toilet Seat	3 lb 1.4 kg	5901100.020	White	34
Commercial Heavy Duty Open Front Elongated Toilet Seat With EverClean® Surface	2 lb 1.3 kg	5901110T.020	White	43

▷ Parts Program

Other seat options

Flush valve adaptor kit containing a 1" (25 mm) chrome plated street ell, a vacuum breaker and a 13" (330 mm) tail piece included to meet minimum 6" (152 mm) code between bowl and vacuum breaker.

ADA when installed with provided seat, top of seat is 17" to 19" (432 to 483 mm) from the finished floor.

Meets all ANSI/ASME Low Consumption, Water Conservation Requirements.

High Efficiency Toilet (HET) utilizes 20% less water than traditional 1.6 gpf/6.0 Lpf toilets at 1.28 gpf (4.8 Lpf) and 31% less water at 1.2 gpf (4.2 Lpf).

Commercial Fixtures

Low Consumption (1.6 gpf/6.0 Lpf) Toilets ✦



Rapidway™ 3-Bolt Wall-Hung Bowl Less Seat

- Unique three bolt elongated wall-hung, top spud flushometer bowl, less seat
- Low consumption, operates at 1.6 gpf/6.0 Lpf
- Blowout flush action
- Conventional Glaze
- 2-1/8" (54 mm) fully-glazed trapway – 2" (51 mm) minimum ballpass
- Condensation channel
- 10" x 12" (254 x 305 mm) water surface area
- 1-1/2" (38 mm) inlet spud

Nominal Dimensions:

25 in x 14-3/16 in x 12-5/8 in (635 mm x 360 mm x 320 mm)



Description	Net Wt	SKU	Color	List Price
Rapidway™ 1.6 gpf/6.0 Lpf Top Spud Elongated Wall-Hung Bowl	38 lb 17.4 kg	3445J101.020	White	442
Rapidway™ 1.6 gpf/6.0 Lpf Back Spud Elongated Wall-Hung Bowl	53 lb 24.5 kg	3445L101.020	White	466

Separate Components:

1-1/2-Inch Toilet Spud	0 lb 0.3 kg	▷047007-0070A	No Finish	25
------------------------	----------------	---------------	-----------	----

Optional Components:

Commercial Heavy Duty Open Front Elongated Toilet Seat	3 lb 1.4 kg	5901100.020	White	34
Commercial Heavy Duty Open Front Elongated Toilet Seat Wth EverClean® Surface	2 lb 1.3 kg	5901110T.020	White	43

▷ Parts Program

Other seat options

ADA when installed with provided seat, top of seat is 17" to 19" (432 to 483 mm) from the finished floor.

Meets all ANSI/ASME Low Consumption, Water Conservation Requirements.

✦ Check local codes to determine if 1.6 gpf toilets are allowed in your area.

Commercial Fixtures

High Efficiency Toilets Operate in the Range of 1.1 – 1.6 gpf (4.2 – 6.0 Lpf)



Priolo® Floor-Mount, Back Outlet EverClean® Bowl Less Seat

- Floor mount, back outlet, elongated flushometer bowl, less seat
- High Efficiency Toilet (HET) operates in the range of 1.1 gpf – 1.6 gpf (4.2 Lpf – 6.0 Lpf)
- Maximum Performance (MaP) score of 1,000 grams at 1.1 - 1.6 gpf
- EverClean® Antimicrobial Surface inhibits the growth of stain and odor causing bacteria, mold and mildew on the surface
- Standard 15" (381 mm) rim height
- Elongated bowl with condensation channel
- Powerful direct-fed siphon jet action
- 2-1/8" (54 mm) fully glazed trapway
- 1-1/2" inlet spud

Nominal Dimensions:

29-5/8 in x 14 in x 15-3/8 in (752 mm x 355 mm x 390 mm)



Description	Net Wt	SKU	Color	List Price
Priolo® 1.1 – 1.6 gpf (4.2 – 6.0 Lpf) Top Spud Back Outlet Elongated EverClean® Bowl	55 lb 25.0 kg	3690001.020	White	424
Priolo® 1.1 – 1.6 gpf (4.2 – 6.0 Lpf) Top Spud Back Outlet Elongated EverClean® Bowl With Bedpan Lugs		3691001.020	White	580

Optional Components:

Commercial Heavy Duty Open Front Elongated Toilet Seat	3 lb 1.4 kg	5901100.020	White	34
Commercial Heavy Duty Open Front Elongated Toilet Seat With EverClean® Surface	2 lb 1.3 kg	5901110T.020	White	43

▷ Parts Program

Other seat options

Meets all ANSI/ASME Low Consumption, Water Conservation Requirements.

High Efficiency Toilet (HET) utilizes 20% less water than traditional 1.6 gpf/6.0 Lpf toilets at 1.28 gpf (4.8 Lpf) and 31% less water at 1.2 gpf (4.2 Lpf).

Commercial Fixtures

High Efficiency Toilets Operate in the Range of 1.1 – 1.6 gpf (4.2 – 6.0 Lpf)



Priolo® Floor-Mount, Back Outlet EverClean® Bowl Less Seat

- Floor mount, back outlet, elongated flushometer bowl, less seat
- High Efficiency Toilet (HET) operates in the range of 1.1 gpf – 1.6 gpf (4.2 Lpf – 6.0 Lpf)
- Maximum Performance (MaP) score of 1,000 grams at 1.1 – 1.6 gpf
- EverClean® Antimicrobial Surface inhibits the growth of stain and odor causing bacteria, mold and mildew on the surface
- 16-½" (419 mm) Chair Height for accessible applications
- Elongated bowl with condensation channel
- Powerful direct-fed siphon jet action
- 2-1/8" (54 mm) fully glazed trapway
- 1-½" inlet spud

Nominal Dimensions:

29-5/8 in x 14 in x 16-7/8 in (752 mm x 355 mm x 428 mm)



Description	Net Wt	SKU	Color	List Price
Priolo® 1.1 – 1.6 gpf (4.2 – 6.0 Lpf) Chair Height Top Spud Back Outlet Elongated EverClean® Bowl	57 lb 25.9 kg	3695001.020	White	565
Priolo® 1.1 – 1.6 gpf (4.2 – 6.0 Lpf) Chair Height Top Spud Back Outlet Elongated EverClean® Bowl With Bedpan Lugs	75 lb 34.0 kg	3696001.020	White	684
Priolo® 1.1 – 1.6 gpf (4.2 – 6.0 Lpf) Chair Height Back Spud Back Outlet Elongated EverClean® Bowl	64 lb 29.1 kg	3697001.020	White	670
Separate Components:				
1-1/2-Inch Toilet Spud	0 lb 0.3 kg	▷047007-0070A	No Finish	25
Optional Components:				
Commercial Heavy Duty Open Front Elongated Toilet Seat	3 lb 1.4 kg	5901100.020	White	34
Commercial Heavy Duty Open Front Elongated Toilet Seat With EverClean® Surface	2 lb 1.3 kg	5901110T.020	White	43

▷ Parts Program

Other seat options

ADA when installed with provided seat, top of seat is 17" to 19" (432 to 483 mm) from the finished floor.

Meets all ANSI/ASME Low Consumption, Water Conservation Requirements.

High Efficiency Toilet (HET) utilizes 20% less water than traditional 1.6 gpf/6.0 Lpf toilets at 1.28 gpf (4.8 Lpf) and 31% less water at 1.2 gpf (4.2 Lpf).

Commercial Fixtures

High Efficiency Toilets Operate in the Range of 1.28 – 1.6 gpf (4.8 – 6.0 Lpf)



Huron® Floor-Mount, Back Outlet EverClean® Bowl Less Seat, Top Spud

- Floor mount, back outlet, elongated flushometer bowl, less seat
- High Efficiency Toilet (HET) operates in the range of 1.28 gpf – 1.6 gpf (4.8 Lpf – 6.0 Lpf)
- Space-saving 24-1/2" (622 mm) from wall to front of bowl
- EverClean® Antimicrobial Surface inhibits the growth of stain and odor causing bacteria, mold and mildew on the surface
- 17-1/8" (435 mm) Chair Height for accessible applications
- 2" (51 mm) fully-glazed trapway
- Powerful direct-fed siphon jet action
- Includes four color-matched bolt caps
- 1-1/2" (38 mm) inlet spud
- With bedpan lugs

Nominal Dimensions:

24-13/16 in x 13-7/8 in x 17-1/8 in (630 mm x 352 mm x 434 mm)



Description	Net Wt	SKU	Color	List Price
Huron® 1.28 – 1.6 gpf (4.8 – 6.0 Lpf) Chair Height Top Spud Back Outlet Elongated EverClean® Bowl	57 lb 25.9 kg	3312001.020	White	515
Huron® 1.28 – 1.6 gpf (4.8 – 6.0 Lpf) Chair Height Top Spud Back Outlet Elongated EverClean® Bowl With Bedpan Lugs		3313001.020	White	537

Separate Components:

1-1/2-Inch Toilet Spud	0 lb 0.3 kg	▷047007-0070A	No Finish	25
------------------------	----------------	---------------	-----------	----

Optional Components:

Commercial Heavy Duty Open Front Elongated Toilet Seat	3 lb 1.4 kg	5901100.020	White	34
Commercial Heavy Duty Open Front Elongated Toilet Seat With EverClean® Surface	2 lb 1.3 kg	5901110T.020	White	43

▷ Parts Program

Other seat options

ADA when installed with provided seat, top of seat is 17" to 19" (432 to 483 mm) from the finished floor.

Meets all ANSI/ASME Low Consumption, Water Conservation Requirements.

High Efficiency Toilet (HET) utilizes 20% less water than traditional 1.6 gpf/6.0 Lpf toilets at 1.28 gpf (4.8 Lpf).

Commercial Fixtures

High Efficiency Toilets Operate in the Range of 1.28 – 1.6 gpf (4.8 – 6.0 Lpf)



Huron® Floor-Mount, Back Outlet EverClean® Bowl With Integral Seat, Top Spud

- Floor mount, back outlet, elongated flushometer bowl, less seat
- High Efficiency Toilet (HET) operates in the range of 1.28 gpf – 1.6 gpf (4.8 Lpf – 6.0 Lpf)
- Space-saving 24-½" (622 mm) from wall to front of bowl
- EverClean® Antimicrobial Surface inhibits the growth of stain and odor causing bacteria, mold and mildew on the surface
- 17-1/8" (435 mm) Chair Height for accessible applications
- 2" (51 mm) fully-glazed trapway
- Powerful direct-fed siphon jet action
- Includes four color-matched bolt caps
- 1-½" (38 mm) inlet spud
- With integral seat

Nominal Dimensions:

24-7/8 in x 13-3/4 in x 18-3/4 in (631 mm x 349 mm x 476 mm)



Description	Net Wt	SKU	Color	List Price
Huron® 1.28 – 1.6 gpf (4.8 – 6.0 Lpf) Chair Height Back Spud Back Outlet Elongated EverClean® Bowl With Integral Seat	60 lb 27.4 kg	3341001.020	White	751
Huron® 1.28 – 1.6 gpf (4.8 – 6.0 Lpf) Chair Height Back Spud Back Outlet Elongated EverClean® Bowl With Integral Seat and Seat Post Holes		3342001.020	White	751
Separate Components:				
1-1/2-Inch Toilet Spud	0 lb 0.3 kg	▷047007-0070A	No Finish	25
Optional Components:				
Commercial Heavy Duty Open Front Elongated Toilet Seat	3 lb 1.4 kg	5901100.020	White	34
Commercial Heavy Duty Open Front Elongated Toilet Seat Wth EverClean® Surface	2 lb 1.3 kg	5901110T.020	White	43

▷ Parts Program

Other seat options

ADA when installed with provided seat, top of seat is 17" to 19" (432 to 483 mm) from the finished floor.

Meets all ANSI/ASME Low Consumption, Water Conservation Requirements.

High Efficiency Toilet (HET) utilizes 20% less water than traditional 1.6 gpf/6.0 Lpf toilets at 1.28 gpf (4.8 Lpf).

Commercial Fixtures

High Efficiency (1.28 gpf/4.8 Lpf) **oilet**



Yorkville® VorMax® Two-Piece 1.28 gpf/4.8 Lpf Chair Height Back Outlet Elongated EverClean® Toilet

- Floor mount, back outlet, gravity flush toilet
- VorMax® flushing technology cleans two times better than conventional toilets*
- Combination bowl and tank, less seat
- 16-½" (419 mm) Chair Height for accessible applications
- High efficiency toilet (HET) 1.28 gpf/4.8 Lpf
- EverClean® Antimicrobial Surface inhibits the growth of stain and odor causing bacteria, mold and mildew on the surface
- CleanCurve® rim eliminates rim area where dirt and build-up hide
- 50% less noise than pressure-assist technology toilets
- Consistently flushes and removes paper seat covers unlike many pressure-assist toilets which tend to rip and leave paper
- Chrome trip lever included

Nominal Dimensions:

30-3/16 in x 18-1/16 in x 32-13/16 in (766 mm x 458 mm x 833 mm)



Description	Net Wt	SKU	Color	List Price
Yorkville® VorMax® Two-Piece 1.28 gpf/4.8 Lpf Chair Height Back Outlet Elongated EverClean® Toilet		209AA137.020	White	905
Yorkville® VorMax® Two-Piece 1.28 gpf/4.8 Lpf Right-Hand Trip Lever Chair Height Back Outlet Elongated EverClean® Toilet		209AA138.020	White	912

Separate Components:

Yorkville® VorMax® Chair Height Back Outlet Elongated EverClean® Bowl	79 lb 36.0 kg	3359A101.020	White	538
Yorkville™ VorMax® 1.28 gpf/4.8 Lpf Left-Hand Trip Lever EverClean® Tank	36 lb 16.5 kg	4385A137.020	White	367
Yorkville® VorMax® 1.28 gpf/4.8 Lpf Right-Hand Trip Lever EverClean® Tank		4385A138.020	White	374
 Yorkville® 12-Inch Rough Toilet Tank Cover	8 lb 3.6 kg	735216-400.020	White	111
Left-Hand Trip Lever	0 lb 0.1 kg	▷7381740-200.0020A	Polished Chrome	73
		▷7381740-200.0130A	Polished Nickel	80
		▷7381740-200.2780A	Legacy Bronze	107
		▷7381740-200.2950A	Brushed Nickel	86

Optional Components:

Yorkville™ VorMax® 1.28 gpf/4.8 Lpf Left-Hand Trip Lever EverClean® Tank With Tank Cover Locking Device	36 lb 16.5 kg	4385A187.020	White	375
Commercial Heavy Duty Open Front Elongated Toilet Seat	3 lb 1.4 kg	5901100.020	White	34
 Contemporary Slow-Close & Easy Lift-Off Elongated Toilet Seat for VorMax® CleanCurve® Style Rims	3 lb 1.7 kg	5055A65C.020	White	108

▷ Parts Program (Non-Premier)

ADA when installed with provided seat, top of seat is 17" to 19" (432 to 483 mm) from the finished floor

Meets all ANSI/ASME Low Consumption, Water Conservation Requirements.

*Source: Test Report No. 109-141-486-002, comparing VorMax against conventional under-the-rim-water-dispersal toilets from major retailers.

Commercial Fixtures

High Efficiency (1.1 gpf/4.2 Lpf) toilet



Yorkville® Two-Piece Pressure Assist 1.1 gpf/4.2 Lpf Chair Height Back Outlet Elongated EverClean® Toilet

- Floor-mounted, back-outlet toilet bowl and tank less seat
- Pressure-assisted siphon jet action
- High efficiency ultra low consumption (1.1 gpf/4.2 Lpf) uses 31% less water
- EverClean® Antimicrobial Surface inhibits the growth of stain and odor causing bacteria, mold and mildew on the surface
- 16-½" (419 mm) Chair Height for accessible applications
- 2-1/8" (54 mm) fully-glazed trapway
- Condensation channel
- 10" x 12" water surface area
- Chrome-plated metal trip lever
- 4 color-matched bolt caps included

Nominal Dimensions:

29-3/4 in x 20-1/2 in x 30-3/4 in (755 mm x 520 mm x 781 mm)



Description	Net Wt	SKU	Color	List Price
Yorkville® Two-Piece Pressure Assist 1.1 gpf/4.2 Lpf Chair Height Back Outlet Elongated EverClean® Toilet		2878100.020	White	905

Separate Components:

Yorkville® Pressure Assist Chair Height Back Outlet Elongated EverClean® Bowl	57 lb 25.9 kg	3703001.020	White	538
Pressure Assist 1.1 gpf/4.2 Lpf Left-Hand Trip Lever EverClean® Tank	42 lb 19.2 kg	4142100.020	White	368
Tank cover	7 lb 3.3 kg	735133-400.020	White	76
Pressure Pod LH Trip Lever	0 lb 0.0 kg	▷7381886-201.0020A	Polished Chrome	80
Pressure Pod RH Trip Lever		▷7381886-202.0020A	Polished Chrome	80

Optional Components:

Pressure Assist 1.1 gpf/4.2 Lpf Left-Hand Trip Lever EverClean® Tank With Tank Cover Locking Device	42 lb 19.2 kg	4142601.020	White	552
Pressure Assist 1.1 gpf/4.2 Lpf Right-Hand Trip Lever EverClean® Tank		4142801.020	White	375
Pressure Assist 1.1 gpf/4.2 Lpf Right-Hand Trip Lever EverClean® Tank With Tank Cover Locking Device		4142901.020	White	559
Tank cover for locking device	7 lb 3.3 kg	735133-401.020	White	76

▷ Parts Program

Other seat options

ADA when installed with provided seat, top of seat is 17" to 19" (432 to 483 mm) from the finished floor.

Meets all ANSI/ASME Low Consumption, Water Conservation Requirements.

Commercial Fixtures

Low Consumption (1.6 gpf/6.0 Lpf) Toilet ✦



Yorkville® Two-Piece Pressure Assist 1.6 gpf/6.0 Lpf Chair Height Back Outlet Elongated EverClean® Toilet

- Floor-mounted, back-outlet toilet bowl and tank less seat
- Pressure-assisted siphon jet action
- Low consumption (1.6 gpf/6.0 Lpf)
- EverClean® Antimicrobial Surface inhibits the growth of stain and odor causing bacteria, mold and mildew on the surface
- 16-½" (419 mm) Chair Height for accessible applications
- 2-1/8" (54 mm) fully-glazed trapway
- Condensation channel
- 10" x 12" water surface area
- Chrome-plated metal trip lever
- 4 color-matched bolt caps included

Nominal Dimensions:

29-3/4 in x 20-1/2 in x 30-3/4 in (755 mm x 520 mm x 781 mm)



Description	Net Wt	SKU	Color	List Price
Yorkville® Two-Piece Pressure Assist 1.6 gpf/6.0 Lpf Chair Height Back Outlet Elongated EverClean® Toilet		2878016.020	White	905

Separate Components:

Yorkville® Pressure Assist Chair Height Back Outlet Elongated EverClean® Bowl	57 lb 25.9 kg	3703001.020	White	538
Pressure Assist 1.6 gpf/6.0 Lpf Left-Hand Trip Lever EverClean® Tank	42 lb 19.2 kg	4142016.020	White	368
Tank cover	7 lb 3.3 kg	735133-400.020	White	76
Pressure Pod LH Trip Lever	0 lb 0.0 kg	▷7381886-201.0020A	Polished Chrome	80
Pressure Pod RH Trip Lever		▷7381886-202.0020A	Polished Chrome	80

Optional Components:

Pressure Assist 1.6 gpf/6.0 Lpf Left-Hand Trip Lever EverClean® Tank With Tank Cover Locking Device	42 lb 19.2 kg	4142600.020	White	552
Pressure Assist 1.6 gpf/6.0 Lpf Right-Hand Trip Lever EverClean® Tank		4142800.020	White	375
Pressure Assist 1.6 gpf/6.0 Lpf Right-Hand Trip Lever EverClean® Tank With Tank Cover Locking Device		4142900.020	White	559
Tank cover for locking device	7 lb 3.3 kg	735133-401.020	White	76

▷ Parts Program

Other seat options

ADA when installed with provided seat, top of seat is 17" to 19" (432 to 483 mm) from the finished floor.

Meets all ANSI/ASME Low Consumption, Water Conservation Requirements.

✦ Check local codes to determine if 1.6 gpf toilets are allowed in your area.

Commercial Fixtures

High Efficiency (1.1 gpf/4.2 Lpf) toilet



Yorkville® Two-Piece Pressure Assist 1.1 gpf/4.2 Lpf Back Outlet Elongated EverClean® Toilet

- Floor-mounted, back-outlet toilet bowl and tank less seat
- Pressure-assisted siphon jet action
- High efficiency ultra low consumption (1.1 gpf/4.2 Lpf) uses 31% less water
- EverClean® Antimicrobial Surface inhibits the growth of stain and odor causing bacteria, mold and mildew on the surface
- Standard 15" (381 mm) rim height
- 2-1/8" (54 mm) fully-glazed trapway
- Condensation channel
- 10" x 12" water surface area
- Chrome-plated metal trip lever
- 4 color-matched bolt caps included

Nominal Dimensions:

29-3/4 in x 20-1/2 in x 30-3/4 in (755 mm x 520 mm x 781 mm)



Description	Net Wt	SKU	Color	List Price
Yorkville® Two-Piece Pressure Assist 1.1 gpf/4.2 Lpf Back Outlet Elongated EverClean® Toilet		2876100.020	White	734

Separate Components:

Yorkville® Pressure Assist Back Outlet Elongated EverClean® Bowl	55 lb 25.2 kg	3701001.020	White	367
Pressure Assist 1.1 gpf/4.2 Lpf Left-Hand Trip Lever EverClean® Tank	42 lb 19.2 kg	4142100.020	White	368
Tank cover	7 lb 3.3 kg	735133-400.020	White	76
Pressure Pod LH Trip Lever	0 lb 0.0 kg	▷7381886-201.0020A	Polished Chrome	80
Pressure Pod RH Trip Lever		▷7381886-202.0020A	Polished Chrome	80

Optional Components:

Pressure Assist 1.1 gpf/4.2 Lpf Left-Hand Trip Lever EverClean® Tank With Tank Cover Locking Device	42 lb 19.2 kg	4142601.020	White	552
Pressure Assist 1.1 gpf/4.2 Lpf Right-Hand Trip Lever EverClean® Tank		4142801.020	White	375
Pressure Assist 1.1 gpf/4.2 Lpf Right-Hand Trip Lever EverClean® Tank With Tank Cover Locking Device		4142901.020	White	559
Tank cover for locking device	7 lb 3.3 kg	735133-401.020	White	76

▷ Parts Program

Other seat options

ADA when installed with provided seat, top of seat is 17" to 19" (432 to 483 mm) from the finished floor.

Meets all ANSI/ASME Low Consumption, Water Conservation Requirements.

Commercial Fixtures

Low Consumption (1.6 gpf/6.0 Lpf) Toilet ✦



Yorkville® Two-Piece Pressure Assist 1.6 gpf/6.0 Lpf Back Outlet Elongated EverClean® Toilet

- Floor-mounted, back-outlet toilet bowl and tank less seat
- Pressure-assisted siphon jet action
- Low consumption (1.6 gpf/6.0 Lpf)
- EverClean® Antimicrobial Surface inhibits the growth of stain and odor causing bacteria, mold and mildew on the surface
- Standard 15" (381 mm) rim height
- 2-1/8" (54 mm) fully-glazed trapway
- Condensation channel
- 10" x 12" water surface area
- Chrome-plated metal trip lever
- 4 color-matched bolt caps included

Nominal Dimensions:

29-3/4 in x 20-1/2 in x 30-3/4 in (755 mm x 520 mm x 781 mm)

Description	Net Wt	SKU	Color	List Price
Yorkville® Two-Piece Pressure Assist 1.6 gpf/6.0 Lpf Back Outlet Elongated EverClean® Toilet		2876016.020	White	734
Separate Components:				
Yorkville® Pressure Assist Back Outlet Elongated EverClean® Bowl	55 lb 25.2 kg	3701001.020	White	367
Pressure Assist 1.6 gpf/6.0 Lpf Left-Hand Trip Lever EverClean® Tank	42 lb 19.2 kg	4142016.020	White	368
Tank cover	7 lb 3.3 kg	735133-400.020	White	76
Pressure Pod LH Trip Lever	0 lb 0.0 kg	▷7381886-201.0020A	Polished Chrome	80
Pressure Pod RH Trip Lever		▷7381886-202.0020A	Polished Chrome	80
Optional Components:				
Pressure Assist 1.6 gpf/6.0 Lpf Left-Hand Trip Lever EverClean® Tank With Tank Cover Locking Device	42 lb 19.2 kg	4142600.020	White	552
Pressure Assist 1.6 gpf/6.0 Lpf Right-Hand Trip Lever EverClean® Tank		4142800.020	White	375
Pressure Assist 1.6 gpf/6.0 Lpf Right-Hand Trip Lever EverClean® Tank With Tank Cover Locking Device		4142900.020	White	559
Tank cover for locking device	7 lb 3.3 kg	735133-401.020	White	76

▷ Parts Program

Other seat options

ADA when installed with provided seat, top of seat is 17" to 19" (432 to 483 mm) from the finished floor.

Meets all ANSI/ASME Low Consumption, Water Conservation Requirements.

✦ Check local codes to determine if 1.6 gpf toilets are allowed in your area.

Commercial Fixtures

High Efficiency (1.28 gpf/4.8 Lpf) **oilet** ✦



Glenwall® VorMax® Two-Piece 1.28 gpf/4.8 Lpf Back Outlet Elongated Wall-Hung EverClean® Toilet

- Elongated wall-hung, top spud flushometer valve toilet, less seat
- VorMax® flushing technology cleans two times better than conventional toilets*. Dual injection flush valves
- Combination bowl and tank, less seat
- Elongated siphon action bowl
- High efficiency toilet (HET) 1.28 gpf/4.8 Lpf
- EverClean® Antimicrobial Surface inhibits the growth of stain and odor causing bacteria, mold and mildew on the surface
- CleanCurve® rim eliminates rim area where dirt and build-up hide
- 50% less noise than pressure-assist technology toilets
- Consistently flushes and removes paper seat covers unlike many pressure-assist toilets which tend to rip and leave paper
- Chrome trip lever included

Nominal Dimensions:

29-1/2 in x 18-1/16 in x 32-1/8 in (749 mm x 458 mm x 815 mm)



Description	Net Wt	SKU	Color	List Price
Glenwall® VorMax® Two-Piece 1.28 gpf/4.8 Lpf Back Outlet Elongated Wall-Hung EverClean® Toilet		2882107.020	White	742
Glenwall® VorMax® Two-Piece 1.28 gpf/4.8 Lpf Right-Hand Trip Lever Back Outlet Elongated Wall-Hung EverClean® Toilet		2882108.020	White	750

Separate Components:

Glenwall® VorMax® Back Outlet Elongated Wall-Hung EverClean® Bowl	71 lb 32.3 kg	3447101.020	White	352
Glenwall® VorMax® 1.28 gpf/4.8 Lpf Left-Hand Trip Lever EverClean® Tank	36 lb 16.5 kg	4385A107.020	White	390
Glenwall® VorMax® 1.28 gpf/4.8 Lpf Right-Hand Trip Lever EverClean® Tank		4385A108.020	White	398
 VorMax® 12-Inch Rough Toilet Tank Cover	8 lb 3.6 kg	735216-400.020	White	111
Left-Hand Trip Lever	0 lb 0.1 kg	▷7381740-200.0020A	Polished Chrome	73
		▷7381740-200.0130A	Polished Nickel	80
		▷7381740-200.2780A	Legacy Bronze	107
		▷7381740-200.2950A	Brushed Nickel	86

Optional Components:

Glenwall® VorMax® 1.28 gpf/4.8 Lpf Left-Hand Trip Lever EverClean® Tank With Tank Cover Locking Device	36 lb 16.5 kg	4385A167.020	White	406
--	------------------	--------------	-------	-----

▷ Parts Program (Non-Premier)

ADA when installed with provided seat, top of seat is 17" to 19" (432 to 483 mm) from the finished floor

Meets all ANSI/ASME Low Consumption, Water Conservation Requirements.

✦ Check local codes to determine if 1.6 gpf toilets are allowed in your area.

*Source: Test Report No. 109-141-486-002, comparing VorMax against conventional under-the-rim-water-dispersal toilets from major retailers.

Commercial Fixtures

High Efficiency (1.1 gpf/4.2 Lpf) oilet



Cadet® Two-Piece Pressure Assist 1.1 gpf/4.2 Lpf Chair Height Elongated EverClean® Toilet

- Combination bowl and tank, less seat
- Pressure-assisted siphon jet flush action
- High efficiency ultra low consumption (1.1 gpf/4.2 Lpf) uses 31% less water
- EverClean® Antimicrobial Surface inhibits the growth of stain and odor causing bacteria, mold and mildew on the surface
- 16-½" (419 mm) Chair Height for accessible applications
- 12" (305 mm) rough-in
- 2-1/8" (54 mm) fully glazed trapway
- Chrome-plated metal trip lever
- Includes two color-matched bolt caps

Nominal Dimensions:

30-1/14 in x 20-1/2 in x 30-3/4 in (763 mm x 520 mm x 781 mm)



Description	Net Wt	SKU	Color	List Price
Cadet® Two-Piece Pressure Assist 1.1 gpf/4.2 Lpf Chair Height Elongated EverClean® Toilet		2467100.020	White	521
Cadet® Two-Piece Pressure Assist 1.1 gpf/4.2 Lpf Chair Height Elongated EverClean® Toilet With Bedpan Lugs		2467136.020	White	544

Separate Components:

Cadet® Pressure Assist Chair Height Elongated EverClean® Bowl	50 lb 23.0 kg	3483001.020	White	154
Cadet® Pressure Assist Chair Height Elongated EverClean® Bowl With Bedpan Lugs		3484001.020	White	176
Pressure Assist 1.1 gpf/4.2 Lpf Left-Hand Trip Lever EverClean® Tank	42 lb 19.2 kg	4142100.020	White	368
Pressure Pod LH Trip Lever	0 lb 0.0 kg	▷7381886-201.0020A	Polished Chrome	80
Pressure Pod RH Trip Lever		▷7381886-202.0020A	Polished Chrome	80

Optional Components:

Pressure Assist 1.1 gpf/4.2 Lpf Left-Hand Trip Lever EverClean® Tank With Tank Cover Locking Device	42 lb 19.2 kg	4142601.020	White	552
Pressure Assist 1.1 gpf/4.2 Lpf Right-Hand Trip Lever EverClean® Tank		4142801.020	White	375
Pressure Assist 1.1 gpf/4.2 Lpf Right-Hand Trip Lever EverClean® Tank With Tank Cover Locking Device		4142901.020	White	559
Tank cover for locking device	7 lb 3.3 kg	735133-401.020	White	76

▷ Parts Program

Other seat options

ADA when installed with provided seat, top of seat is 17" to 19" (432 to 483 mm) from the finished floor.

Meets all ANSI/ASME Low Consumption, Water Conservation Requirements.

Commercial Fixtures

Low Consumption (1.6 gpf/6.0 Lpf) Toilet ✦



Cadet® Two-Piece Pressure Assist 1.6 gpf/6.0 Lpf Chair Height Elongated EverClean® Toilet

- Combination bowl and tank, less seat
- Pressure-assisted siphon jet flush action
- Low consumption (1.6 gpf/6.0 Lpf)
- EverClean® Antimicrobial Surface inhibits the growth of stain and odor causing bacteria, mold and mildew on the surface
- 16-½" (419 mm) Chair Height for accessible applications
- 12" (305 mm) rough-in
- 2-1/8" (54 mm) fully glazed trapway
- Chrome-plated metal trip lever
- Includes two color-matched bolt caps

Nominal Dimensions:

30-1/14 in x 20-1/2 in x 30-3/4 in (763 mm x 520 mm x 781 mm)



Description	Net Wt	SKU	Color	List Price
Cadet® Two-Piece Pressure Assist 1.6 gpf/6.0 Lpf Chair Height Elongated EverClean® Toilet		2467016.020	White	521
Separate Components:				
Cadet® Pressure Assist Chair Height Elongated EverClean® Bowl	50 lb 23.0 kg	3483001.020	White	154
Pressure Assist 1.6 gpf/6.0 Lpf Left-Hand Trip Lever EverClean® Tank	42 lb 19.2 kg	4142016.020	White	368
Tank cover	7 lb 3.3 kg	735133-400.020	White	76
Pressure Pod LH Trip Lever	0 lb 0.0 kg	▷7381886-201.0020A	Polished Chrome	80
Pressure Pod RH Trip Lever		▷7381886-202.0020A	Polished Chrome	80
Optional Components:				
Pressure Assist 1.6 gpf/6.0 Lpf Left-Hand Trip Lever EverClean® Tank With Tank Cover Locking Device	42 lb 19.2 kg	4142600.020	White	552
Pressure Assist 1.6 gpf/6.0 Lpf Right-Hand Trip Lever EverClean® Tank		4142800.020	White	375
Pressure Assist 1.6 gpf/6.0 Lpf Right-Hand Trip Lever EverClean® Tank With Tank Cover Locking Device		4142900.020	White	559
Tank cover for locking device	7 lb 3.3 kg	735133-401.020	White	76

▷ Parts Program

Other seat options

ADA when installed with provided seat, top of seat is 17" to 19" (432 to 483 mm) from the finished floor.

Meets all ANSI/ASME Low Consumption, Water Conservation Requirements.

✦ Check local codes to determine if 1.6 gpf toilets are allowed in your area.

Commercial Fixtures

High Efficiency (1.1 gpf/4.2 Lpf) toilet



Cadet® Two-Piece Pressure Assist 1.1 gpf/4.2 Lpf Elongated EverClean® Toilet

- Combination bowl and tank, less seat
- Pressure-assisted siphon jet flush action
- High efficiency ultra low consumption (1.1 gpf/4.2 Lpf) uses 31% less water
- EverClean® Antimicrobial Surface inhibits the growth of stain and odor causing bacteria, mold and mildew on the surface
- Standard 15" (381 mm) rim height
- 12" (305 mm) rough-in
- 2-1/8" (54 mm) fully glazed trapway
- Chrome-plated metal trip lever
- Includes two color-matched bolt caps

Nominal Dimensions:

30-1/14 in x 20-1/2 in x 29-1/4 in (763 mm x 520 mm x 742 mm)

Description	Net Wt	SKU	Color	List Price
Cadet® Two-Piece Pressure Assist 1.1 gpf/4.2 Lpf Elongated EverClean® Toilet		2462100.020	White	494
Separate Components:				
Cadet® Pressure Assist Elongated EverClean® Bowl	48 lb 22.0 kg	3481001.020	White	127
Pressure Assist 1.1 gpf/4.2 Lpf Left-Hand Trip Lever EverClean® Tank	42 lb 19.2 kg	4142100.020	White	368
Tank cover	7 lb 3.3 kg	735133-400.020	White	76
Pressure Pod LH Trip Lever	0 lb 0.0 kg	▷7381886-201.0020A	Polished Chrome	80
Pressure Pod RH Trip Lever		▷7381886-202.0020A	Polished Chrome	80
Optional Components:				
Pressure Assist 1.1 gpf/4.2 Lpf Left-Hand Trip Lever EverClean® Tank With Tank Cover Locking Device	42 lb 19.2 kg	4142601.020	White	552
Pressure Assist 1.1 gpf/4.2 Lpf Right-Hand Trip Lever EverClean® Tank		4142801.020	White	375
Pressure Assist 1.1 gpf/4.2 Lpf Right-Hand Trip Lever EverClean® Tank With Tank Cover Locking Device		4142901.020	White	559
Tank cover for locking device	7 lb 3.3 kg	735133-401.020	White	76

▷ Parts Program

Other seat options

Meets all ANSI/ASME Low Consumption, Water Conservation Requirements.

Commercial Fixtures

Low Consumption (1.6 gpf/6.0 Lpf) Toilet ✦



Cadet® Two-Piece Pressure Assist 1.6 gpf/6.0 Lpf Elongated EverClean® Toilet

- Combination bowl and tank, less seat
- Pressure-assisted siphon jet flush action
- Low consumption (1.6 gpf/6.0 Lpf)
- EverClean® Antimicrobial Surface inhibits the growth of stain and odor causing bacteria, mold and mildew on the surface
- Standard 15" (381 mm) rim height
- 12" (305 mm) rough-in
- 2-1/8" (54 mm) fully glazed trapway
- Chrome-plated metal trip lever
- Includes two color-matched bolt caps

Nominal Dimensions:

30-1/4 in x 20-1/2 in x 29-1/4 in (768 mm x 520 mm x 742 mm)

Description	Net Wt	SKU	Color	List Price
Cadet® Two-Piece Pressure Assist 1.6 gpf/6.0 Lpf Elongated EverClean® Toilet		2462016.020	White	494

Separate Components:

Cadet® Pressure Assist Elongated EverClean® Bowl	48 lb 22.0 kg	3481001.020	White	127
Pressure Assist 1.6 gpf/6.0 Lpf Left-Hand Trip Lever EverClean® Tank	42 lb 19.2 kg	4142016.020	White	368
Tank cover	7 lb 3.3 kg	735133-400.020	White	76
Pressure Pod LH Trip Lever	0 lb 0.0 kg	▷7381886-201.0020A	Polished Chrome	80
Pressure Pod RH Trip Lever		▷7381886-202.0020A	Polished Chrome	80

Optional Components:

Pressure Assist 1.6 gpf/6.0 Lpf Left-Hand Trip Lever EverClean® Tank With Tank Cover Locking Device	42 lb 19.2 kg	4142600.020	White	552
Pressure Assist 1.6 gpf/6.0 Lpf Right-Hand Trip Lever EverClean® Tank		4142800.020	White	375
Pressure Assist 1.6 gpf/6.0 Lpf Right-Hand Trip Lever EverClean® Tank With Tank Cover Locking Device		4142900.020	White	559
Tank cover for locking device	7 lb 3.3 kg	735133-401.020	White	76

▷ Parts Program

Other seat options

Meets all ANSI/ASME Low Consumption, Water Conservation Requirements.

✦ Check local codes to determine if 1.6 gpf toilets are allowed in your area.

Commercial Fixtures

Two-Piece Toilet Platforms

BEST



When used with 1.0 gpf tanks



VorMax® HET/UHET

Available Flush Volumes	1.0 gpf/3.8 Lpf or 1.28 gpf/4.8 Lpf
Available Rough-in	12" (305 mm)
Flush Valve	A 1-3/4" (44 mm) Dual Injectors
Siphon Outlet	B 2-1/16" (52 mm)
Bowl Hydraulics	C CleanCurve® with 2X Better Bowl Cleaning†
MaP* Flush Score	Best 1,000 g
Surface†	EverClean®
Warranty	Longest 10-Year Limited Warranty

BEST



When used with 1.28 gpf tanks



Champion® PRO

Available Flush Volumes	1.28 gpf/4.8 Lpf or 1.6 gpf/6.0 Lpf
Available Rough-in	12" (305 mm)
Flush Valve	A 4" (102 mm) Largest Available
Siphon Outlet	B 2-3/8" (60 mm) Largest Siphonic Available
Bowl Hydraulics	C PowerWash®
MaP* Flush Score	Best 1,000 g
Surface†	EverClean®
Warranty	Longest 10-Year Limited Warranty

BETTER



When used with 1.28 gpf tanks



Cadet® PRO

Available Flush Volumes	1.28 gpf/4.8 Lpf or 1.6 gpf/6.0 Lpf
Available Rough-in	10", 12" or 14" (254, 305, or 356 mm)
Flush Valve	A 3" (76 mm)
Siphon Outlet	B 2-1/8" (54 mm)
Bowl Hydraulics	C PowerWash®
MaP* Flush Score	Best 1,000 g
Surface†	EverClean®
Warranty	5-Year Limited Warranty

* Maximum Performance (MaP) testing performed by IAPMO R&T Lab. MaP Report conducted by Gauley Associates Ltd. and Koeller and Company.

† EverClean surface is an antimicrobial surface that inhibits the growth of stain and odor causing bacteria, mold and mildew.

‡ Source: IAPMO R&T Labs Test Report No. 109-141486-002, comparing VorMax against conventional under-the-rim-water-dispersal toilets from major retailers.

Commercial Fixtures

No-Touch Flush for Home and Business

Cadet® Touchless Toilets are chair height, elongated styles designed for comfort and ease of use. Available with smooth, skirted sides to conceal trapway for easy cleaning, or with exposed trapway less seat, both feature our exclusive EverClean® surface to inhibit the growth of bacteria, and use 1.28 gpf volume to conserve water without sacrificing performance.



Optional Tank Cover Lock Device (TCLD) tank 4000769 with locking sensor tab now available for “vandal resistant” commercial bathroom applications.



2-1/2 inch diameter sensor module can be installed on wall within 3 feet of toilet or on top of toilet tank with supplied screws or backing tape.



When installed with recommended seats listed below, top of seat is 17" to 19" (432 to 483 mm) from the finished floor.



TOUCHLESS FLUSH — Wave hand slowly within 1-1/2 inches of sensor face for approximately two seconds to trigger a powerful flush



MANUAL FLUSH — Push and hold the left side actuator button for approximately two seconds ensuring continual operation in the event batteries need replacing



BATTERIES INCLUDED — One-year battery life powered by 3 AAA sensor and 4 AA control module batteries, based on an average of 12 flushes per day



Includes signage to educate users how to activate the no-touch flush technology.

Fixture Color



CADET TOUCHLESS TOILET COMBINATION	COMBINATION	BOWL	TANK	SLOW-CLOSE SEAT
Concealed Trap Elongated With Seat	2989709	3075000	4000709	502465G (packed with bowl)
Concealed Trap Elongated With TCLD Option and Seat	2989769	3075000	4000769	502465G (packed with bowl)
Exposed Trap Elongated Less Seat	215AA709	3517A101	4000709	5503A00B (order separately)
Exposed Trap Elongated With TCLD Option Less Seat	215AA769	3517A101	4000769	5503A00B (order separately)

Commercial Fixtures

High Efficiency (1.28 gpf/4.8 Lpf) **oilet**



Cadet® Touchless Chair Height Elongated Toilet With Concealed Trapway

- Simple hand wave touchless flush technology
- 2-½" (64 mm) diameter sensor module can be installed on wall within 3 feet of toilet or on top of toilet tank itself
- Siphon action jetted bowl with smooth-sided, concealed trapway
- Ultra-low consumption (1.28 gpf/4.8 Lpf) utilizes 20% less water
- Meets EPA WaterSense® criteria
- 12" (305 mm) rough installation
- 3" (76 mm) flush valve with integrated fill valve
- 2-1/8" (54 mm) trapway bowl with EverClean® surface included
- Obtains best 1,000g MaP flush score*
- Includes top mount, slow-close seat and cover with easy lift-off feature for cleaning
- Powered by 3AAA sensor and 4AA control module batteries (included)
- Convenient, manual Polished Chrome override flush actuator on side of tank
- Limited lifetime warranty on chinaware, limited five-year warranty on all mechanical parts, and limited one-year warranty on electronic parts and seat

Nominal Dimensions:

30-3/16 in x 15-13/16 in x 30-11/16 in (766 mm x 401 mm x 779 mm)



Description	Net Wt	SKU	Color	List Price
Cadet® Touchless Chair Height Elongated Toilet With Concealed Trapway		2989709.020	White	726
Cadet® Touchless Chair Height Elongated Skirted Toilet with Seat and Locking Device		2989769.020	White	762

Separate Components:

Cadet® 3 FloWise® Skirted Chair Height Elongated Bowl With Seat	72 lb 33.1 kg	3075000.020	White	471
Cadet® Touchless 1.28 gpf Single Flush Toilet Tank Only	29 lb 13.3 kg	4000709.020	White	255
Cadet Touchless 1.28 gpf Single Flush Toilet Tank Only with Locking Device		4000769.020	White	291
Touchless Sensor	0 lb 0.2 kg	▷7381981-201.0070A	No Finish	97
Manual Override Button	0 lb 0.0 kg	▷7381982-201.0020A	Polished Chrome	9
		▷7381982-201.0200A	White	9
Studio 12-Inch Rough Tank Cover	7 lb 3.3 kg	735158-400.020	White	71

Optional Components:

Transitional Slow-Close & Easy Lift-Off Elongated Toilet Seat	6 lb 3.0 kg	5024A65G.020	White	131
---	----------------	--------------	-------	-----

▷ Parts Program (Non-Premier)

ADA when installed with provided seat, top of seat is 17" to 19" (432 to 483 mm) from the finished floor
Meets all ANSI/ASME Low Consumption, Water Conservation Requirements.

Commercial Fixtures

High Efficiency (1.28 gpf/4.8 Lpf) **oilet**



Cadet® Touchless Chair Height Elongated Toilet Less Seat

- Combination tank and bowl, less seat
- Simple hand wave touchless flush technology
- 2-1/2" (64 mm) diameter sensor module can be installed on wall within 3 feet of toilet or on top of toilet tank itself
- Siphon action jetted bowl
- Ultra-low consumption (1.28 gpf/4.8 Lpf) utilizes 20% less water
- Meets EPA WaterSense® criteria
- 12" (305 mm) rough installation
- 3" (76 mm) flush valve with integrated fill valve
- 2-1/8" (54 mm) trapway bowl with EverClean® surface included
- Obtains best 1,000g MaP flush score*
- Powered by 3AAA sensor and 4AA control module batteries (included)
- Convenient, manual Polished Chrome override flush actuator on side of tank
- Limited lifetime warranty on chinaware, limited five-year warranty on all mechanical parts, and limited one-year warranty on electronic parts

Nominal Dimensions:

30-3/16 in x 15-13/16 in x 30-11/16 in (766 mm x 401 mm x 779 mm)



Description	Net Wt	SKU	Color	List Price
Cadet® Touchless Chair Height Elongated Toilet Less Seat		215AA709.020	White	519
Cadet® Touchless Chair Height Elongated Toilet with Locking Device - Less Seat		215AA769.020	White	555

Separate Components:

Cadet® PRO Chair Height Elongated Toilet Bowl Only	55 lb 25.0 kg	3517A101.020	White	264
* Cadet® Touchless 1.28 gpf Single Flush Toilet Tank Only	29 lb 13.3 kg	4000709.020	White	255
* Cadet Touchless 1.28 gpf Single Flush Toilet Tank Only with Locking Device		4000769.020	White	291
*Touchless Sensor	0 lb 0.2 kg	▷7381981-201.0070A	No Finish	97
Manual Override Button	0 lb 0.0 kg	▷7381982-201.0020A	Polished Chrome	9
		▷7381982-201.0200A	White	9
Studio 12-Inch Rough Tank Cover	7 lb 3.3 kg	735158-400.020	White	71

Optional Components:

* Transitional Slow-Close Elongated Toilet Seat	2 lb 1.3 kg	5503A00B.020	White	57
---	----------------	--------------	-------	----

▷ Parts Program (Non-Premier)

* Tank and seat only are Premier

ADA when installed with provided seat, top of seat is 17" to 19" (432 to 483 mm) from the finished floor

Meets all ANSI/ASME Low Consumption, Water Conservation Requirements.

Commercial Fixtures

Ultra-High Efficiency (1.0 gpf/3.8 Lpf) toilets



VorMax® Two-Piece 1.0 gpf/3.8 Lpf Chair Height Elongated Toilet Less Seat

- VorMax® flushing technology cleans two times better than conventional toilets*
- Combination bowl and tank, less seat
- 12" (305 mm) rough-in
- Chair Height elongated siphon action bowl
- Ultra-high efficiency toilet (UHET) 1.0 gpf/3.8 Lpf
- Meets EPA WaterSense® and MaP Premium criteria
- EverClean® Antimicrobial Surface
- Transitional styling
- CleanCurve® rim eliminates rim area where dirt and build-up hide
- 16-½" (419 mm) rim height for accessible applications
- 2-1/16" (52 mm) trapway
- Dual injection flush valves
- Chrome trip lever
- Two color-matched bolt caps
- 10-year warranty



Nominal Dimensions:

30-3/16 in x 17-7/8 in x 32-1/4 in (766 mm x 454 mm x 819 mm)



Description	Net Wt	SKU	Color	List Price
VorMax® Two-Piece 1.0 gpf/3.8 Lpf Chair Height Elongated Toilet Less Seat		238AA114.020	White	504

Separate Components:

VorMax® Chair Height Elongated Bowl	57 lb 25.9 kg	3385A101.020	White	262
VorMax® 1.0 gpf/3.8 Lpf 12-Inch Rough Tank Only	36 lb 16.5 kg	4385A114.020	White	242
VorMax® 12-Inch Rough Toilet Tank Cover	8 lb 3.6 kg	735216-400.020	White	111
Left-Hand Trip Lever	0 lb 0.1 kg	▷7381740-200.0020A	Polished Chrome	73
		▷7381740-200.0130A	Polished Nickel	80
		▷7381740-200.2780A	Legacy Bronze	107
		▷7381740-200.2950A	Brushed Nickel	86

Optional Components:

Contemporary Slow-Close & Easy Lift-Off Elongated Toilet Seat for VorMax® CleanCurve® Style Rims	3 lb 1.7 kg	5055A65C.020	White	108
--	----------------	--------------	-------	-----

▷ Parts Program (Non-Premier)

ADA when installed with provided seat, top of seat is 17" to 19" (432 to 483 mm) from the finished floor

Meets all ANSI/ASME Low Consumption, Water Conservation Requirements.

*Source: Test Report No. 109-141486-002, comparing VorMax against conventional under-the-rim-water-dispersal toilets from major retailers.

Commercial Fixtures

High Efficiency (1.28 gpf/4.8 Lpf) toilet



VorMax® Two-Piece 1.28 gpf/4.8 Lpf Chair Height Elongated Toilet Less Seat

- VorMax® flushing technology cleans two times better than conventional toilets*
- Combination bowl and tank, less seat
- 12" (305 mm) rough-in
- Chair Height elongated siphon action bowl
- High efficiency toilet (HET) 1.28 gpf/4.8 Lpf
- Meets EPA WaterSense®
- EverClean® Antimicrobial Surface
- Transitional styling
- CleanCurve® rim eliminates rim area where dirt and build-up hide
- 16-½" (419 mm) rim height for accessible applications
- 2-1/16" (52 mm) trapway
- Dual injection flush valves
- Chrome trip lever
- Two color-matched bolt caps
- 10-year warranty
- Meets MaP Premium criteria

Nominal Dimensions:

30-3/16 in x 17-7/8 in x 32-1/4 in (766 mm x 454 mm x 819 mm)



Description	Net Wt	SKU	Color	List Price
VorMax® Two-Piece 1.28 gpf/4.8 Lpf Chair Height Elongated Toilet Less Seat		238AA104.020	White	504

Separate Components:

VorMax® Chair Height Elongated Bowl	57 lb 25.9 kg	3385A101.020	White	262
VorMax® 1.28 gpf/4.8 Lpf 12-Inch Rough Tank	36 lb 16.7 kg	4385A104.020	White	242
VorMax® 12-Inch Rough Toilet Tank Cover	8 lb 3.6 kg	735216-400.020	White	111
Left-Hand Trip Lever	0 lb 0.1 kg	▷7381740-200.0020A	Polished Chrome	73
		▷7381740-200.0130A	Polished Nickel	80
		▷7381740-200.2780A	Legacy Bronze	107
		▷7381740-200.2950A	Brushed Nickel	86

Optional Components:

Contemporary Slow-Close & Easy Lift-Off Elongated Toilet Seat for VorMax® CleanCurve® Style Rims	3 lb 1.7 kg	5055A65C.020	White	108
--	----------------	--------------	-------	-----

▷ Parts Program (Non-Premier)

ADA when installed with provided seat, top of seat is 17" to 19" (432 to 483 mm) from the finished floor

Meets all ANSI/ASME Low Consumption, Water Conservation Requirements.

*Source: Test Report No. 109-141486-002, comparing VorMax against conventional under-the-rim-water-dispersal toilets from major retailers.

Commercial Fixtures

High Efficiency (1.28 gpf/4.8 Lpf) toilets



Champion® PRO Two-Piece 1.28 gpf/4.8 Lpf Chair Height Elongated Toilet Less Seat

- Combination bowl and tank, less seat
- High efficiency, ultra-low consumption (1.28 gpf/4.8 Lpf), utilizes 20% less water
- Meets EPA WaterSense® criteria
- Trade specific tank
- PowerWash® – Powerful flush to help clean bowl surface
- Metal trip lever
- Metal shank fill valve
- Includes EZ-Install Tools
- EverClean® Antimicrobial Surface
- 4" (102 mm) piston-action Accelerator™ flush valve
- 2-3/8" (60 mm) fully-glazed trapway
- 16-1/2" (419 mm) rim height for accessible applications
- 12" (305 mm) rough-in
- 10-year warranty

Nominal Dimensions:

30-1/4 in x 19 in x 31 in (768 mm x 482 mm x 787 mm)



Description	Net Wt	SKU	Color	List Price
Champion® PRO Two-Piece 1.28 gpf/4.8 Lpf Chair Height Elongated Toilet Less Seat		211AA104.020	White	533
		211AA104.021	Bone	670
		211AA104.222	Linen	670
Champion® PRO Two-Piece 1.28 gpf/4.8 Lpf Chair Height Elongated Right-Hand Trip Lever Toilet Less Seat		211AA105.020	White	563

Separate Components:

Champion® PRO Chair Height Elongated Bowl	57 lb 25.9 kg	3195A101.020	White	303
		3195A101.021	Bone	378
		3195A101.222	Linen	378
Champion® PRO 1.28 gpf/4.8 Lpf 12-Inch Rough Tank	31 lb 14.1 kg	4225A104.020	White	230
		4225A104.021	Bone	292
		4225A104.222	Linen	292
Champion® PRO 1.28 gpf/4.8 Lpf 12-Inch Rough Right Hand Trip Lever Tank		4225A105.020	White	260
Champion® PRO 12-Inch Rough Toilet Tank Cover	8 lb 3.7 kg	735171-400.020	White	98
		735171-400.021	Bone	124
		735171-400.222	Linen	124
Left-Hand Trip Lever	0 lb 0.2 kg	▷7381232-200.0020A	Polished Chrome	42
		▷7381232-200.0130A	Polished Nickel	46
		▷7381232-200.0200A	White	52
		▷7381232-200.2240A	Oil Rubbed Bronze	103
		▷7381232-200.2780A	Legacy Bronze	78
Right-Hand Trip Lever	0 lb 0.2 kg	▷7381232-200.2950A	Brushed Nickel	55
		▷7381232-201.2950A	Brushed Nickel	55

Optional Components:

Champion® Slow-Close & Easy Lift-Off Elongated Toilet Seat	3 lb 1.6 kg	5321A65CT.020	White	98
		5321A65CT.021	Bone	123
		5321A65CT.222	Linen	123

▷ Parts Program

Other seat options

Additional tanks

ADA when installed with provided seat, top of seat is 17" to 19" (432 to 483 mm) from the finished floor

Meets all ANSI/ASME Low Consumption, Water Conservation Requirements.

Commercial Fixtures

High Efficiency (1.28 gpf/4.8 Lpf) toilets



Champion® PRO Two-Piece 1.28 gpf/4.8 Lpf Chair Height Round Front Toilet Less Seat

- Combination bowl and tank, less seat
- High efficiency, ultra-low consumption (1.28 gpf/4.8 Lpf), utilizes 20% less water
- Meets EPA WaterSense® criteria
- Trade specific tank
- PowerWash® – Powerful flush to help clean bowl surface
- Metal trip lever
- Metal shank fill valve
- Includes EZ-Install Tools
- EverClean® Antimicrobial Surface
- 4" (102 mm) piston-action Accelerator™ flush valve
- 2-3/8" (60 mm) fully-glazed trapway
- 16-1/2" (419 mm) rim height for accessible applications
- 12" (305 mm) rough-in
- 10-year warranty

Nominal Dimensions:

28-1/4 in x 19 in x 31 in (717 mm x 482 mm x 787 mm)



Description	Net Wt	SKU	Color	List Price
Champion® PRO Two-Piece 1.28 gpf/4.8 Lpf Chair Height Round Front Toilet Less Seat		211BA104.020	White	477
		211BA104.021	Bone	598
		211BA104.222	Linen	598
Champion® PRO Two-Piece 1.28 gpf/4.8 Lpf Chair Height Round Front Right-Hand Trip Lever Toilet Less Seat		211BA105.020	White	507
Separate Components:				
Champion® PRO Chair Height Round Front Bowl	57 lb 25.9 kg	3195B101.020	White	247
		3195B101.021	Bone	306
		3195B101.222	Linen	306
Champion® PRO 1.28 gpf/4.8 Lpf 12-Inch Rough Tank	31 lb 14.1 kg	4225A104.020	White	230
		4225A104.021	Bone	292
		4225A104.222	Linen	292
Champion® PRO 1.28 gpf/4.8 Lpf 12-Inch Rough Right Hand Trip Lever Tank		4225A105.020	White	260
Champion® PRO 12-Inch Rough Toilet Tank Cover	8 lb 3.7 kg	735171-400.020	White	98
		735171-400.021	Bone	124
		735171-400.222	Linen	124
Left-Hand Trip Lever	0 lb 0.2 kg	▷7381232-200.0020A	Polished Chrome	42
		▷7381232-200.0130A	Polished Nickel	46
		▷7381232-200.0200A	White	52
		▷7381232-200.2240A	Oil Rubbed Bronze	103
		▷7381232-200.2780A	Legacy Bronze	78
Right-Hand Trip Lever	0 lb 0.2 kg	▷7381232-200.2950A	Brushed Nickel	55
		▷7381232-201.2950A	Brushed Nickel	55

Optional Components:

Champion® Slow-Close & Easy Lift-Off Round Front Toilet Seat	3 lb 1.4 kg	5320B65CT.020	White	83
		5320B65CT.021	Bone	110
		5320B65CT.222	Linen	110

▷ Parts Program

Other seat options

Additional tanks

ADA when installed with provided seat, top of seat is 17" to 19" (432 to 483 mm) from the finished floor

Meets all ANSI/ASME Low Consumption, Water Conservation Requirements.

Commercial Fixtures

High Efficiency (1.28 gpf/4.8 Lpf) toilets



Champion® PRO Two-Piece 1.28 gpf/4.8 Lpf Standard Height Elongated Toilet Less Seat

- Combination bowl and tank, less seat
- High efficiency, ultra-low consumption (1.28 gpf/4.8 Lpf), utilizes 20% less water
- Meets EPA WaterSense® criteria
- Trade specific tank
- PowerWash® – Powerful flush to help clean bowl surface
- Metal trip lever
- Metal shank fill valve
- Includes EZ-Install Tools
- EverClean® Antimicrobial Surface
- 4" (102 mm) piston-action Accelerator™ flush valve
- 2-3/8" (60 mm) fully-glazed trapway
- 12" (305 mm) rough-in
- 10-year warranty

Nominal Dimensions:

30-1/4 in x 19 in x 29-3/8 in (768 mm x 482 mm x 746 mm)



Description	Net Wt	SKU	Color	List Price
Champion® PRO Two-Piece 1.28 gpf/4.8 Lpf Standard Height Elongated Toilet Less Seat		211CA104.020	White	490
Champion® PRO Two-Piece 1.28 gpf/4.8 Lpf Standard Height Right-Hand Trip Lever Elongated Toilet Less Seat		211CA105.020	White	520

Separate Components:

Champion® PRO Standard Height Elongated Bowl	55 lb 25.1 kg	3195C101.020	White	260
Champion® PRO 1.28 gpf/4.8 Lpf 12-Inch Rough Tank	31 lb 14.1 kg	4225A104.020	White	230
Champion® PRO 1.28 gpf/4.8 Lpf 12-Inch Rough Right Hand Trip Lever Tank	31 lb 14.3 kg	4225A105.020	White	260
Champion® PRO 12-Inch Rough Toilet Tank Cover	8 lb 3.7 kg	735171-400.020	White	98
Left-Hand Trip Lever	0 lb 0.2 kg	▷7381232-200.0020A	Polished Chrome	42
	0 lb 0.1 kg	▷7381232-200.0130A	Polished Nickel	46
	0 lb 0.2 kg	▷7381232-200.0200A	White	52
		▷7381232-200.2240A	Oil Rubbed Bronze	103
	0 lb 0.1 kg	▷7381232-200.2780A	Legacy Bronze	78
Right-Hand Trip Lever	0 lb 0.2 kg	▷7381232-200.2950A	Brushed Nickel	55
		▷7381232-201.2950A	Brushed Nickel	55

Optional Components:

Champion® Slow-Close & Easy Lift-Off Elongated Toilet Seat	3 lb 1.6 kg	5321A65CT.020	White	98
--	----------------	---------------	-------	----

▷ Parts Program

Other seat options

Additional tanks

Meets all ANSI/ASME Low Consumption, Water Conservation Requirements.

Commercial Fixtures

Low Consumption (1.6 gpf/6.0 Lpf) Toilets ✦



Champion® PRO Two-Piece 1.6 gpf/6.0 Lpf Chair Height Elongated Toilet Less Seat

- Combination bowl and tank, less seat
- Low consumption (1.6 gpf/6.0 Lpf)
- Trade specific tank
- PowerWash® – Powerful flush to help clean bowl surface
- Metal trip lever and metal shank fill valve
- Includes EZ-Install Tools
- EverClean® Antimicrobial Surface
- 4" (102 mm) piston-action Accelerator™ fl sh valve
- 2-3/8" (60 mm) fully-glazed trapway
- 16-1/2" (419 mm) rim height for accessible applications
- 12" (305 mm) rough-in
- 10-year warranty

Nominal Dimensions:

29-3/16 in x 19 in x 30-7/8 in (741 mm x 482 mm x 784 mm)



Description	Net Wt	SKU	Color	List Price
Champion® PRO Two-Piece 1.6 gpf/6.0 Lpf Chair Height Elongated Toilet Less Seat		211AA004.020	White	533
		211AA004.021	Bone	670
		211AA004.222	Linen	670
Champion® PRO Two-Piece 1.6 gpf/6.0 Lpf Chair Height Elongated Right-Hand Trip Lever Toilet Less Seat		211AA005.020	White	563

Separate Components:

Champion® PRO Chair Height Elongated Bowl	57 lb 25.9 kg	3195A101.020	White	303
		3195A101.021	Bone	378
		3195A101.222	Linen	378
Champion® PRO 1.6 gpf/6.0 Lpf 12-Inch Rough Tank	31 lb 14.1 kg	4225A004.020	White	230
		4225A004.021	Bone	292
		4225A004.222	Linen	292
Champion® PRO 1.6 gpf/6.0 Lpf 12-Inch Rough Right-Hand Trip Lever Tank		4225A005.020	White	260
Champion® PRO 12-Inch Rough Toilet Tank Cover	8 lb 3.7 kg	735171-400.020	White	98
		735171-400.021	Bone	124
		735171-400.222	Linen	124
Left-Hand Trip Lever	0 lb 0.2 kg	▷7381232-200.0020A	Polished Chrome	42
		▷7381232-200.0130A	Polished Nickel	46
		▷7381232-200.0200A	White	52
		▷7381232-200.2240A	Oil Rubbed Bronze	103
		▷7381232-200.2780A	Legacy Bronze	78
Right-Hand Trip Lever	0 lb 0.2 kg	▷7381232-200.2950A	Brushed Nickel	55
		▷7381232-201.2950A	Brushed Nickel	55

Optional Components:

Champion® Slow-Close & Easy Lift-Off Elongated Toilet Seat	3 lb 1.6 kg	5321A65CT.020	White	98
		5321A65CT.021	Bone	123
		5321A65CT.222	Linen	123

▷ Parts Program

Other seat options

Additional tanks

ADA when installed with provided seat, top of seat is 17" to 19" (432 to 483 mm) from the finish floor

Meets all ANSI/ASME Low Consumption, Water Conservation Requirements.

✦ Check your local codes to determine if 1.6 gpf/6.0 Lpf toilets are allowed in your area.

Commercial Fixtures

Low Consumption (1.6 gpf/6.0 Lpf) Toilets ✦



Champion® PRO Two-Piece 1.6 gpf/6.0 Lpf Chair Height Round Front Toilet Less Seat

- Combination bowl and tank, less seat
- Low consumption (1.6 gpf/6.0 Lpf)
- Trade specific tank
- PowerWash® – Powerful flush to help clean bowl surface
- Metal trip lever
- Metal shank fill valve
- Includes EZ-Install Tools
- EverClean® Antimicrobial Surface
- 4" (102 mm) piston-action Accelerator™ fl sh valve
- 2-3/8" (60 mm) fully-glazed trapway
- 12" (305 mm) rough-in
- 10-year warranty

Nominal Dimensions:

28-1/4 in x 19 in x 31 in (717 mm x 482 mm x 787 mm)



Description	Net Wt	SKU	Color	List Price
Champion® PRO Two-Piece 1.6 gpf/6.0 Lpf Chair Height Round Front Toilet Less Seat		211BA004.020	White	477
		211BA004.021	Bone	598
		211BA004.222	Linen	598
Champion PRO Two-Piece 1.6 gpf/6.0 Lpf Chair Height Round Front Right-Hand Trip Lever Toilet Less Seat		211BA005.020	White	507

Separate Components:

Champion® PRO Chair Height Round Front Bowl	57 lb 25.9 kg	3195B101.020	White	247
		3195B101.021	Bone	306
		3195B101.222	Linen	306
Champion® PRO 1.6 gpf/6.0 Lpf 12-Inch Rough Tank	31 lb 14.1 kg	4225A004.020	White	230
		4225A004.021	Bone	292
		4225A004.222	Linen	292
Champion® PRO 1.6 gpf/6.0 Lpf 12-Inch Rough Right-Hand Trip Lever Tank		4225A005.020	White	260
Champion® PRO 12-Inch Rough Toilet Tank Cover	8 lb 3.7 kg	735171-400.020	White	98
		735171-400.021	Bone	124
		735171-400.222	Linen	124
Left-Hand Trip Lever	0 lb 0.2 kg	▷7381232-200.0020A	Polished Chrome	42
		▷7381232-200.0130A	Polished Nickel	46
		▷7381232-200.0200A	White	52
		▷7381232-200.2240A	Oil Rubbed Bronze	103
		▷7381232-200.2780A	Legacy Bronze	78
Right-Hand Trip Lever	0 lb 0.2 kg	▷7381232-200.2950A	Brushed Nickel	55
		▷7381232-201.2950A	Brushed Nickel	55

Optional Components:

Champion® Slow-Close & Easy Lift-Off Round Front Toilet Seat	3 lb 1.4 kg	5320B65CT.020	White	83
		5320B65CT.021	Bone	110
		5320B65CT.222	Linen	110

▷ Parts Program

Other seat options

Additional tanks

ADA when installed with provided seat, top of seat is 17" to 19" (432 to 483 mm) from the finish floor

Meets all ANSI/ASME Low Consumption, Water Conservation Requirements.

✦ Check your local codes to determine if 1.6 gpf/6.0 Lpf toilets are allowed in your area.

Commercial Fixtures

High Efficiency (1.28 gpf/4.8 Lpf) toilets



Champion® PRO Two-Piece 1.28 gpf/4.8 Lpf Standard Height Elongated Toilet Less Seat

- Combination bowl and tank, less seat
- High efficiency, ultra-low consumption (1.28 gpf/4.8 Lpf), utilizes 20% less water
- Meets EPA WaterSense® criteria
- Trade specific tank
- PowerWash® – Powerful flush to help clean bowl surface
- Metal trip lever
- Metal shank fill valve
- Includes EZ-Install Tools
- EverClean® Antimicrobial Surface
- 4" (102 mm) piston-action Accelerator™ fl sh valve
- 2-3/8" (60 mm) fully-glazed trapway
- 12" (305 mm) rough-in
- 10-year warranty

Nominal Dimensions:

30-1/4 in x 19 in x 29-3/8 in (768 mm x 482 mm x 746 mm)

Description	Net Wt	SKU	Color	List Price
Champion® PRO Two-Piece 1.28 gpf/4.8 Lpf Standard Height Elongated Toilet Less Seat		211CA104.020	White	490
Champion® PRO Two-Piece 1.28 gpf/4.8 Lpf Standard Height Right-Hand Trip Lever Elongated Toilet Less Seat		211CA105.020	White	520
Separate Components:				
Champion® PRO Standard Height Elongated Bowl	55 lb 25.1 kg	3195C101.020	White	260
Champion® PRO 1.28 gpf/4.8 Lpf 12-Inch Rough Tank	31 lb 14.1 kg	4225A104.020	White	230
Champion® PRO 1.28 gpf/4.8 Lpf 12-Inch Rough Right Hand Trip Lever Tank	31 lb 14.3 kg	4225A105.020	White	260
Champion® PRO 12-Inch Rough Toilet Tank Cover	8 lb 3.7 kg	735171-400.020	White	98
Left-Hand Trip Lever	0 lb 0.2 kg	▷7381232-200.0020A	Polished Chrome	42
	0 lb 0.1 kg	▷7381232-200.0130A	Polished Nickel	46
	0 lb 0.2 kg	▷7381232-200.0200A	White	52
		▷7381232-200.2240A	Oil Rubbed Bronze	103
	0 lb 0.1 kg	▷7381232-200.2780A	Legacy Bronze	78
Right-Hand Trip Lever	0 lb 0.2 kg	▷7381232-200.2950A	Brushed Nickel	55
		▷7381232-201.2950A	Brushed Nickel	55
Optional Components:				
Champion® Slow-Close & Easy Lift-Off Elongated Toilet Seat	3 lb 1.6 kg	5321A65CT.020	White	98

▷ Parts Program

Other seat options

Additional tanks

Meets all ANSI/ASME Low Consumption, Water Conservation Requirements.

Commercial Fixtures

High Efficiency (1.28 gpf/4.8 Lpf) toilets



Cadet® PRO Two-Piece 1.28 gpf/4.8 Lpf Chair Height Elongated Toilet Less Seat

- Combination bowl and tank, less seat
- 12" (305 mm) rough-in
- High efficiency, ultra-low consumption (1.28 gpf/4.8 Lpf), utilizes 20% less water
- Meets EPA WaterSense® criteria
- Trade specific tank
- PowerWash® – Powerful flush to help clean bowl surface
- Metal trip lever
- Metal shank fill valve
- Includes EZ-Install Tools
- EverClean® Antimicrobial Surface
- 16-½" (419 mm) rim height for accessible application
- 2-1/8" (54 mm) fully glazed trapway
- 9" x 8" (229 x 203 mm) water surface area
- 3" (76 mm) flush valve
- Five-year warranty

Nominal Dimensions:

30-1/4 in x 17-1/4 in x 30-1/4 in (768 mm x 438 mm x 768 mm)



Description	Net Wt	SKU	Color	List Price
Cadet® PRO Two-Piece 1.28 gpf/4.8 Lpf Chair Height Elongated Toilet Less Seat		215AA104.020	White	413
		215AA104.021	Bone	509
		215AA104.222	Linen	509
Cadet® PRO Two-Piece 1.28 gpf/4.8 Lpf Chair Height Elongated Right-Hand Trip Lever Toilet Less Seat		215AA105.020	White	421

Separate Components:

Cadet® PRO Chair Height Elongated Toilet Bowl Only	55 lb 25.0 kg	3517A101.020	White	264
		3517A101.021	Bone	327
		3517A101.222	Linen	327
Cadet® PRO 1.28 gpf/4.8 Lpf 12-Inch Rough Tank	27 lb 12.6 kg	4188A104.020	White	149
		4188A104.021	Bone	182
		4188A104.222	Linen	182
Cadet® PRO 1.28 gpf/4.8 Lpf 12-Inch Rough Right-Hand Trip Lever Tank		4188A105.020	White	157
Cadet® PRO 12-Inch Rough Toilet Tank Cover	7 lb 3.3 kg	735172-400.020	White	94
		735172-400.021	Bone	119
		735172-400.222	Linen	119
Left-Hand Trip Lever	0 lb 0.2 kg	▷7381231-200.0020A	Polished Chrome	37
		▷7381231-200.0130A	Polished Nickel	46
		▷7381231-200.0200A	White	45
		▷7381231-200.0990A	Polished Brass	45
		▷7381231-200.2240A	Oil Rubbed Bronze	67
		▷7381231-200.2780A	Legacy Bronze	108
Right-Hand Trip Lever	0 lb 0.2 kg	▷7381231-201.0020A	Polished Chrome	37
		▷7381231-201.2950A	Brushed Nickel	54

▷ Parts Program

Other seat options

Additional tanks

ADA when installed with provided seat, top of seat is 17" to 19" (432 to 483 mm) from the finish floor

Meets all ANSI/ASME Low Consumption, Water Conservation Requirements.

Commercial Fixtures

High Efficiency (1.28 gpf/4.8 Lpf) toilets



Cadet® PRO Two-Piece 1.28 gpf/4.8 Lpf Chair Height Round Front Toilet Less Seat

- Combination bowl and tank, less seat
- 12" (305 mm) rough-in
- High efficiency, ultra-low consumption (1.28 gpf/4.8 Lpf), utilizes 20% less water
- Meets EPA WaterSense® criteria
- Trade specific tank
- PowerWash® – Powerful flush to help clean bowl surface
- Metal trip lever
- Metal shank fill valve
- Includes EZ-Install Tools
- EverClean® Antimicrobial Surface
- 16-1/2" (419 mm) rim height for accessible application
- 2-1/8" (54 mm) fully glazed trapway
- 9" x 8" (229 x 203 mm) water surface area
- 3" (76 mm) flush valve
- Five-year warranty

Nominal Dimensions:

28-1/4 in x 17-1/4 in x 30-1/4 in (717 mm x 438 mm x 768 mm)



Description	Net Wt	SKU	Color	List Price
Cadet® PRO Two-Piece 1.28 gpf/4.8 Lpf Chair Height Round Front Toilet Less Seat		215BA104.020	White	396
		215BA104.021	Bone	489
		215BA104.222	Linen	489
Cadet® PRO Two-Piece 1.28 gpf/4.8 Lpf Chair Height Round Front Right-Hand Trip Lever Toilet Less Seat		215BA105.020	White	404

Separate Components:

Cadet® PRO Chair Height Round Front Bowl	52 lb 23.9 kg	3517B101.020	White	247
		3517B101.021	Bone	307
		3517B101.222	Linen	307
Cadet® PRO 1.28 gpf/4.8 Lpf 12-Inch Rough Tank	27 lb 12.6 kg	4188A104.020	White	149
		4188A104.021	Bone	182
		4188A104.222	Linen	182
Cadet® PRO 1.28 gpf/4.8 Lpf 12-Inch Rough Right-Hand Trip Lever Tank		4188A105.020	White	157
Cadet® PRO 12-Inch Rough Toilet Tank Cover	7 lb 3.3 kg	735172-400.020	White	94
		735172-400.021	Bone	119
		735172-400.222	Linen	119
Left-Hand Trip Lever	0 lb 0.2 kg	▷7381231-200.0020A	Polished Chrome	37
		▷7381231-200.0130A	Polished Nickel	46
		▷7381231-200.0200A	White	45
		▷7381231-200.0990A	Polished Brass	45
		▷7381231-200.2240A	Oil Rubbed Bronze	67
		▷7381231-200.2780A	Legacy Bronze	108
Right-Hand Trip Lever	0 lb 0.0 kg	▷7381231-200.2950A	Brushed Nickel	54
		▷7381231-201.2950A	Brushed Nickel	54

Optional Components:

Cardiff™ Slow-Close Round Front Toilet Seat	3 lb 1.4 kg	5259B65MT.020	White	65
		5259B65MT.021	Bone	71
		5259B65MT.222	Linen	71

▷ Parts Program

Other seat options

Additional tanks

ADA when installed with provided seat, top of seat is 17" to 19" (432 to 483 mm) from the finished floor

Meets all ANSI/ASME Low Consumption, Water Conservation Requirements.

Commercial Fixtures

Low Consumption (1.6 gpf/6.0 Lpf) Toilets ✦



Cadet® PRO Two-Piece 1.6 gpf/6.0 Lpf Chair Height Elongated Toilet Less Seat

- Combination bowl and tank, less seat
- 12" (305 mm) rough-in
- Low consumption (1.6 gpf/6.0 Lpf)
- Trade specific tank
- PowerWash® – Powerful flush to help clean bowl surface
- Metal trip lever
- Metal shank fill valve
- Includes EZ-Install Tools
- EverClean® Antimicrobial Surface
- 16-½" (419 mm) rim height for accessible application
- 2-1/8" (54 mm) fully glazed trapway
- 9" x 8" (229 x 203 mm) water surface area
- 3" (76 mm) flush valve
- Five-year warranty

Nominal Dimensions:

29-1/8 in x 17-3/8 in x 30-3/8 in (739 mm x 441 mm x 771 mm)



Description	Net Wt	SKU	Color	List Price
Cadet® PRO Two-Piece 1.6 gpf/6.0 Lpf Chair Height Elongated Toilet Less Seat		215AA004.020	White	413
		215AA004.021	Bone	509
		215AA004.222	Linen	509
Cadet® PRO Two-Piece 1.6 gpf/6.0 Lpf Chair Height Elongated Right-Hand Trip Lever Toilet Less Seat		215AA005.020	White	421
Separate Components:				
Cadet® PRO Chair Height Elongated Toilet Bowl Only	55 lb 25.0 kg	3517A101.020	White	264
		3517A101.021	Bone	327
		3517A101.222	Linen	327
Cadet® PRO 1.6 gpf/6.0 Lpf 12-Inch Rough Tank	27 lb 12.6 kg	4188A004.020	White	149
		4188A004.021	Bone	182
		4188A004.222	Linen	182
Cadet® PRO 1.6 gpf/6.0 Lpf 12-Inch Rough Right-Hand Trip Lever Tank		4188A005.020	White	157
Cadet PRO® 12-Inch Rough Toilet Tank Cover	7 lb 3.3 kg	735172-400.020	White	94
		735172-400.021	Bone	119
		735172-400.222	Linen	119
Left-Hand Trip Lever	0 lb 0.2 kg	▷7381231-200.0020A	Polished Chrome	37
		▷7381231-200.0130A	Polished Nickel	46
		▷7381231-200.0200A	White	45
		▷7381231-200.0990A	Polished Brass	45
		▷7381231-200.2240A	Oil Rubbed Bronze	67
	0 lb 0.1 kg	▷7381231-200.2780A	Legacy Bronze	108
		▷7381231-200.2950A	Brushed Nickel	54
Right-Hand Trip Lever	0 lb 0.2 kg	▷7381231-201.2950A	Brushed Nickel	54
Optional Components:				
Cardiff™ Slow-Close Elongated Toilet Seat	3 lb 1.5 kg	5257A65MT.020	White	71
		5257A65MT.021	Bone	78
		5257A65MT.222	Linen	78

▷ Parts Program

Other seat options

Additional tanks

ADA when installed with provided seat, top of seat is 17" to 19" (432 to 483 mm) from the finish floor

Meets all ANSI/ASME Low Consumption, Water Conservation Requirements.

✦ Check your local codes to determine if 1.6 gpf/6.0 Lpf toilets are allowed in your area.

Commercial Fixtures

Low Consumption (1.6 gpf/6.0 Lpf) Toilets ✦



Cadet® PRO Two-Piece 1.6 gpf/6.0 Lpf Chair Height Round Front Toilet Less Seat

- Combination bowl and tank, less seat
- 12" (305 mm) rough-in
- Low consumption (1.6 gpf/6.0 Lpf)
- Trade specific tank
- PowerWash® – Powerful flush to help clean bowl surface
- Metal trip lever
- Metal shank fill valve
- Includes EZ-Install Tools
- EverClean® Antimicrobial Surface
- 16-1/2" (419 mm) rim height for accessible application
- 2-1/8" (54 mm) fully glazed trapway
- 9" x 8" (229 x 203 mm) water surface area
- 3" (76 mm) flush valve
- Five-year warranty

Nominal Dimensions:

28-1/4 in x 17-1/4 in x 30-1/4 in (717 mm x 438 mm x 768 mm)



Description	Net Wt	SKU	Color	List Price
Cadet® PRO Two-Piece 1.6 gpf/6.0 Lpf Chair Height Round Front Toilet Less Seat		215BA004.020	White	396
		215BA004.021	Bone	489
		215BA004.222	Linen	489
Cadet® PRO Two-Piece 1.6 gpf/6.0 Lpf Chair Height Round Front Right-Hand Trip Lever Toilet Less Seat		215BA005.020	White	404

Separate Components:

Cadet® PRO Chair Height Round Front Bowl	52 lb 23.9 kg	3517B101.020	White	247
		3517B101.021	Bone	307
		3517B101.222	Linen	307
Cadet® PRO 1.6 gpf/6.0 Lpf 12-Inch Rough Tank	27 lb 12.6 kg	4188A004.020	White	149
		4188A004.021	Bone	182
		4188A004.222	Linen	182
Cadet® PRO 1.6 gpf/6.0 Lpf 12-Inch Rough Right-Hand Trip Lever Tank		4188A005.020	White	157
Cadet® PRO 12-Inch Rough Toilet Tank Cover	7 lb 3.3 kg	735172-400.020	White	94
		735172-400.021	Bone	119
		735172-400.222	Linen	119
Left-Hand Trip Lever	0 lb 0.2 kg	▷7381231-200.0020A	Polished Chrome	37
		▷7381231-200.0130A	Polished Nickel	46
		▷7381231-200.0200A	White	45
		▷7381231-200.0990A	Polished Brass	45
		▷7381231-200.2240A	Oil Rubbed Bronze	67
	0 lb 0.1 kg	▷7381231-200.2780A	Legacy Bronze	108
		▷7381231-200.2950A	Brushed Nickel	54
Right-Hand Trip Lever	0 lb 0.2 kg	▷7381231-201.2950A	Brushed Nickel	54

Optional Components:

Cardiff™ Slow-Close Round Front Toilet Seat	3 lb 1.4 kg	5259B65MT.020	White	65
		5259B65MT.021	Bone	71
		5259B65MT.222	Linen	71

▷ Parts Program

Other seat options

Additional tanks

ADA when installed with provided seat, top of seat is 17" to 19" (432 to 483 mm) from the finish floor

Meets all ANSI/ASME Low Consumption, Water Conservation Requirements.

✦ Check your local codes to determine if 1.6 gpf/6.0 Lpf toilets are allowed in your area.

Commercial Fixtures

High Efficiency (1.28 gpf/4.8 Lpf) **oilet**



Cadet® PRO Two-Piece 1.28 gpf/4.8 Lpf Chair Height Elongated 10-Inch Rough Toilet Less Seat

- Combination bowl and tank, less seat
- 10" (254 mm) rough-in
- High efficiency, ultra-low consumption (1.28 gpf/4.8 Lpf), utilizes 20% less water
- Meets EPA WaterSense® criteria
- Trade specific tank
- PowerWash® – Powerful flush to help clean bowl surface
- Metal trip lever
- Metal shank fill valve
- Includes EZ-Install Tools
- EverClean® Antimicrobial Surface
- 16-1/2" (419 mm) rim height for accessible application
- 2-1/8" (54 mm) fully glazed trapway
- 9" x 8" (229 x 203 mm) water surface area
- 3" (76 mm) flush valve
- Five-year warranty

Nominal Dimensions:

28-1/2 in x 18 in x 30-1/4 in (723 mm x 457 mm x 768 mm)



Description	Net Wt	SKU	Color	List Price
Cadet® PRO Two-Piece 1.28 gpf/4.8 Lpf Chair Height Elongated 10-Inch Rough Toilet Less Seat		215AB104.020	White	467
		215AB104.021	Bone	669
		215AB104.222	Linen	669
Separate Components:				
Cadet® PRO Chair Height Elongated Toilet Bowl Only	55 lb 25.0 kg	3517A101.020	White	264
		3517A101.021	Bone	327
		3517A101.222	Linen	327
Cadet® PRO 1.28 gpf/4.8 Lpf 10-Inch Rough Tank	27 lb 12.3 kg	4188B104.020	White	203
		4188B104.021	Bone	342
		4188B104.222	Linen	342
Cadet® PRO 10-Inch Rough Toilet Tank Cover	6 lb 2.9 kg	735173-400.020	White	107
		735173-400.021	Bone	124
		735173-400.222	Linen	124
Left-Hand Trip Lever	0 lb 0.2 kg	▷7381231-200.0020A	Polished Chrome	37
		▷7381231-200.0130A	Polished Nickel	46
		▷7381231-200.0200A	White	45
		▷7381231-200.0990A	Polished Brass	45
		▷7381231-200.2240A	Oil Rubbed Bronze	67
		▷7381231-200.2780A	Legacy Bronze	108
		▷7381231-200.2950A	Brushed Nickel	54
Optional Components:				
Cardiff™ Slow-Close Elongated Toilet Seat	3 lb 1.5 kg	5257A65MT.020	White	71
		5257A65MT.021	Bone	78
		5257A65MT.222	Linen	78

▷ Parts Program

Other seat options

Additional tanks

ADA when installed with provided seat, top of seat is 17" to 19" (432 to 483 mm) from the finished floor.

Meets all ANSI/ASME Low Consumption, Water Conservation Requirements.

Commercial Fixtures

High Efficiency (1.28 gpf/4.8 Lpf) toilet



Cadet® PRO Two-Piece 1.28 gpf/4.8 Lpf Chair Height Round Front 10-Inch Rough Toilet Less Seat

- Combination bowl and tank, less seat
- 10" (254 mm) rough-in
- High efficiency, ultra-low consumption (1.28 gpf/4.8 Lpf), utilizes 20% less water
- Meets EPA WaterSense® criteria
- Trade specific tank
- PowerWash® – Powerful flush to help clean bowl surface
- Metal trip lever
- Metal shank fill valve
- Includes EZ-Install Tools
- EverClean® Antimicrobial Surface
- 16-1/2" (419 mm) rim height for accessible application
- 2-1/8" (54 mm) fully glazed trapway
- 9" x 8" (229 x 203 mm) water surface area
- 3" (76 mm) flush valve
- Five-year warranty

Nominal Dimensions:

26-1/4 in x 18 in x 30-1/4 in (666 mm x 457 mm x 768 mm)



Description	Net Wt	SKU	Color	List Price
Cadet® PRO Two-Piece 1.28 gpf/4.8 Lpf Chair Height Round Front 10-Inch Rough Toilet Less Seat		215BB104.020	White	450
		215BB104.021	Bone	649
		215BB104.222	Linen	649

Separate Components:

Cadet® PRO Chair Height Round Front Bowl	52 lb 23.9 kg	3517B101.020	White	247
		3517B101.021	Bone	307
		3517B101.222	Linen	307
Cadet® PRO 1.28 gpf/4.8 Lpf 10-Inch Rough Tank	27 lb 12.3 kg	4188B104.020	White	203
		4188B104.021	Bone	342
		4188B104.222	Linen	342
Cadet® PRO 10-Inch Rough Toilet Tank Cover	6 lb 2.9 kg	735173-400.020	White	107
		735173-400.021	Bone	124
		735173-400.222	Linen	124
Left-Hand Trip Lever	0 lb 0.2 kg	▷7381231-200.0020A	Polished Chrome	37
		▷7381231-200.0130A	Polished Nickel	46
		▷7381231-200.0200A	White	45
		▷7381231-200.0990A	Polished Brass	45
		▷7381231-200.2240A	Oil Rubbed Bronze	67
		▷7381231-200.2780A	Legacy Bronze	108
		▷7381231-200.2950A	Brushed Nickel	54

Optional Components:

Cardiff™ Slow-Close Round Front Toilet Seat	3 lb 1.4 kg	5259B65MT.020	White	65
		5259B65MT.021	Bone	71
		5259B65MT.222	Linen	71

▷ Parts Program

Other seat options

Additional tanks

ADA when installed with provided seat, top of seat is 17" to 19" (432 to 483 mm) from the finished floor.

Meets all ANSI/ASME Low Consumption, Water Conservation Requirements.

Commercial Fixtures

Low Consumption (1.6 gpf/6.0 Lpf) Toilet ✦



Cadet® PRO Two-Piece 1.6 gpf/6.0 Lpf Chair Height Elongated 10-Inch Rough Toilet Less Seat

- Combination bowl and tank, less seat
- 10" (254 mm) rough-in
- Low consumption (1.6 gpf/6.0 Lpf)
- Trade specific tank
- PowerWash® – Powerful flush to help clean bowl surface
- Metal trip lever
- Metal shank fill valve
- Includes EZ-Install Tools
- EverClean® Antimicrobial Surface
- 16-½" (419 mm) rim height for accessible application
- 2-1/8" (54 mm) fully glazed trapway
- 9" x 8" (229 x 203 mm) water surface area
- 3" (76 mm) flush valve
- Five-year warranty

Nominal Dimensions:

28-1/2 in x 18 in x 30-1/4 in (723 mm x 457 mm x 768 mm)



Description	Net Wt	SKU	Color	List Price
Cadet® PRO Two-Piece 1.6 gpf/6.0 Lpf Chair Height Elongated 10-Inch Rough Toilet Less Seat		215AB004.020	White	467
		215AB004.021	Bone	669
		215AB004.222	Linen	669
Separate Components:				
Cadet® PRO Chair Height Elongated Toilet Bowl Only	55 lb 25.0 kg	3517A101.020	White	264
		3517A101.021	Bone	327
		3517A101.222	Linen	327
Cadet® PRO 1.6 gpf/6.0 Lpf 10-Inch Rough Tank	27 lb 12.3 kg	4188B004.020	White	203
		4188B004.021	Bone	342
		4188B004.222	Linen	342
Cadet® PRO 10-Inch Rough Toilet Tank Cover	6 lb 2.9 kg	735173-400.020	White	107
		735173-400.021	Bone	124
		735173-400.222	Linen	124
Left-Hand Trip Lever	0 lb 0.2 kg	▷7381231-200.0020A	Polished Chrome	37
		▷7381231-200.0130A	Polished Nickel	46
		▷7381231-200.0200A	White	45
		▷7381231-200.0990A	Polished Brass	45
		▷7381231-200.2240A	Oil Rubbed Bronze	67
		▷7381231-200.2780A	Legacy Bronze	108
		▷7381231-200.2950A	Brushed Nickel	54
Optional Components:				
Cardiff™ Slow-Close Elongated Toilet Seat	3 lb 1.5 kg	5257A65MT.020	White	71
		5257A65MT.021	Bone	78
		5257A65MT.222	Linen	78

Toilets

▷ Parts Program

Other seat options

Additional tanks

ADA when installed with provided seat, top of seat is 17" to 19" (432 to 483 mm) from the finished floor.

Meets all ANSI/ASME Low Consumption, Water Conservation Requirements.

✦Check your local codes to determine if 1.6 gpf/6.0 Lpf toilets are allowed in your area.

Commercial Fixtures

Low Consumption (1.6 gpf/6.0 Lpf) Toilet ✦



Cadet® PRO Two-Piece 1.6 gpf/6.0 Lpf Chair Height Round Front 10-Inch Rough Toilet Less Seat

- Combination bowl and tank, less seat
- 10" (254 mm) rough-in
- Low consumption (1.6 gpf/6.0 Lpf)
- Trade specific tank
- PowerWash® – Powerful flush to help clean bowl surface
- Metal trip lever
- Metal shank fill valve
- Includes EZ-Install Tools
- EverClean® Antimicrobial Surface
- 16-1/2" (419 mm) rim height for accessible application
- 2-1/8" (54 mm) fully glazed trapway
- 9" x 8" (229 x 203 mm) water surface area
- 3" (76 mm) flush valve
- Five-year warranty

Nominal Dimensions:

26-1/4 in x 18 in x 30-1/4 in (666 mm x 457 mm x 768 mm)



Description	Net Wt	SKU	Color	List Price
Cadet® PRO Two-Piece 1.6 gpf/6.0 Lpf Chair Height Round Front 10-Inch Rough Toilet Less Seat		215BB004.020	White	450
		215BB004.021	Bone	649
		215BB004.222	Linen	649

Separate Components:

Cadet® PRO Chair Height Round Front Bowl	52 lb 23.9 kg	3517B101.020	White	247
		3517B101.021	Bone	307
		3517B101.222	Linen	307
Cadet® PRO 1.6 gpf/6.0 Lpf 10-Inch Rough Tank	27 lb 12.3 kg	4188B004.020	White	203
		4188B004.021	Bone	342
		4188B004.222	Linen	342
Cadet® PRO 10-Inch Rough Toilet Tank Cover	6 lb 2.9 kg	735173-400.020	White	107
		735173-400.021	Bone	124
		735173-400.222	Linen	124
Left-Hand Trip Lever	0 lb 0.2 kg	▷7381231-200.0020A	Polished Chrome	37
		▷7381231-200.0130A	Polished Nickel	46
		▷7381231-200.0200A	White	45
		▷7381231-200.0990A	Polished Brass	45
		▷7381231-200.2240A	Oil Rubbed Bronze	67
		▷7381231-200.2780A	Legacy Bronze	108
		▷7381231-200.2950A	Brushed Nickel	54

Optional Components:

Cardiff™ Slow-Close Round Front Toilet Seat	3 lb 1.4 kg	5259B65MT.020	White	65
		5259B65MT.021	Bone	71
		5259B65MT.222	Linen	71

▷ Parts Program

Other seat options

Additional tanks

ADA when installed with provided seat, top of seat is 17" to 19" (432 to 483 mm) from the finished floor.

Meets all ANSI/ASME Low Consumption, Water Conservation Requirements.

✦ Check your local codes to determine if 1.6 gpf/6.0 Lpf toilets are allowed in your area.

Commercial Fixtures

High Efficiency (1.28 gpf/4.8 Lpf) **oilet**



Cadet® PRO Two-Piece 1.28 gpf/4.8 Lpf Compact Chair Height Elongated Toilet Less Seat

- Combination bowl and tank, less seat
- Space saving elongated bowl fits in the space of a round front
- 12" (305 mm) rough-in
- High efficiency, ultra-low consumption (1.28 gpf/4.8 Lpf), utilizes 20% less water
- Meets EPA WaterSense® criteria
- PowerWash® – Powerful flush to help clean bowl surface
- Trade specific tank
- Metal trip lever
- Metal shank fill valve
- Includes EZ-Install Tools
- EverClean® Antimicrobial Surface
- 16-½" (419 mm) rim height for accessible application
- 2-1/8" (54 mm) fully glazed trapway
- 9" x 8" (229 x 203 mm) water surface area
- 3" (76 mm) flush valve
- Five-year warranty

Nominal Dimensions:

28-1/4 in x 18 in x 30-3/8 in (717 mm x 457 mm x 771 mm)



Description	Net Wt	SKU	Color	List Price
Cadet® PRO Two-Piece 1.28 gpf/4.8 Lpf Compact Chair Height Elongated Toilet Less Seat		215FA104.020	White	481
		215FA104.021	Bone	817
		215FA104.222	Linen	817

Separate Components:

Cadet® PRO Compact Chair Height Elongated Bowl	55 lb 25.0 kg	3517F101.020	White	278
		3517F101.021	Bone	475
		3517F101.222	Linen	475
Cadet® PRO 1.28 gpf/4.8 Lpf 10-Inch Rough Tank	27 lb 12.3 kg	4188B104.020	White	203
		4188B104.021	Bone	342
		4188B104.222	Linen	342
Cadet® PRO 10-Inch Rough Toilet Tank Cover	6 lb 2.9 kg	735173-400.020	White	107
		735173-400.021	Bone	124
		735173-400.222	Linen	124
Left-Hand Trip Lever	0 lb 0.2 kg	▷7381231-200.0020A	Polished Chrome	37
		▷7381231-200.0130A	Polished Nickel	46
		▷7381231-200.0200A	White	45
		▷7381231-200.0990A	Polished Brass	45
		▷7381231-200.2240A	Oil Rubbed Bronze	67
		▷7381231-200.2780A	Legacy Bronze	108
		▷7381231-200.2950A	Brushed Nickel	54

Optional Components:

Cardiff™ Slow-Close Elongated Toilet Seat	3 lb 1.5 kg	5257A65MT.020	White	71
		5257A65MT.021	Bone	78
		5257A65MT.222	Linen	78

▷ Parts Program

Other seat options

Additional tanks

ADA when installed with provided seat, top of seat is 17" to 19" (432 to 483 mm) from the finished floor.

Meets all ANSI/ASME Low Consumption, Water Conservation Requirements.

Commercial Fixtures

High Efficiency (1.28 gpf/4.8 Lpf) **oilet**



Cadet® PRO Two-Piece 1.28 gpf/4.8 Lpf Compact Chair Height Elongated 14-Inch Rough Toilet Less Seat

- Combination bowl and tank, less seat
- Space saving elongated bowl fits in the space of a round front
- 14" (356 mm) rough-in
- High efficiency, ultra-low consumption (1.28 gpf/4.8 Lpf), utilizes 20% less water
- Meets EPA WaterSense® criteria
- PowerWash® – Powerful flush to help clean bowl surface
- Trade specific tank
- Metal trip lever
- Metal shank fill valve
- Includes EZ-Install Tools
- EverClean® Antimicrobial Surface
- 16-1/2" (419 mm) rim height for accessible application
- 2-1/8" (54 mm) fully glazed trapway
- 9" x 8" (229 x 203 mm) water surface area
- 3" (76 mm) flush valve
- Five-year warranty

Nominal Dimensions:

30 in x 17-3/8 in x 30-3/8 in (762 mm x 441 mm x 771 mm)



Description	Net Wt	SKU	Color	List Price
Cadet® PRO Two-Piece 1.28 gpf/4.8 Lpf Compact Chair Height Elongated 14-Inch Rough Toilet Less Seat		215FC104.020	White	427
		215FC104.021	Bone	657
		215FC104.222	Linen	657
Separate Components:				
Cadet® PRO Compact Chair Height Elongated Bowl	55 lb 25.0 kg	3517F101.020	White	278
		3517F101.021	Bone	475
		3517F101.222	Linen	475
Cadet® PRO 1.28 gpf/4.8 Lpf 12-Inch Rough Tank	27 lb 12.6 kg	4188A104.020	White	149
		4188A104.021	Bone	182
		4188A104.222	Linen	182
Cadet® PRO 12-Inch Rough Toilet Tank Cover	7 lb 3.3 kg	735172-400.020	White	94
		735172-400.021	Bone	119
		735172-400.222	Linen	119
Left-Hand Trip Lever	0 lb 0.2 kg	▷7381231-200.0020A	Polished Chrome	37
		▷7381231-200.0130A	Polished Nickel	46
		▷7381231-200.0200A	White	45
		▷7381231-200.0990A	Polished Brass	45
		▷7381231-200.2240A	Oil Rubbed Bronze	67
		▷7381231-200.2780A	Legacy Bronze	108
		▷7381231-200.2950A	Brushed Nickel	54
Optional Components:				
Cardiff™ Slow-Close Elongated Toilet Seat	3 lb 1.5 kg	5257A65MT.020	White	71
		5257A65MT.021	Bone	78
		5257A65MT.222	Linen	78

▷ Parts Program
Other seat options
Additional tanks

ADA when installed with provided seat, top of seat is 17" to 19" (432 to 483 mm) from the finished floor.
Meets all ANSI/ASME Low Consumption, Water Conservation Requirements.

Commercial Fixtures

Low Consumption (1.6 gpf/6.0 Lpf) Toilet ✦



Cadet® PRO Two-Piece 1.6 gpf/6.0 Lpf Compact Chair Height Elongated Toilet Less Seat

- Combination bowl and tank, less seat
- Space saving elongated bowl fits in the space of a round front
- 12" (305 mm) rough-in
- Low consumption (1.6 gpf/6.0 Lpf)
- Trade specific tank
- PowerWash® – Powerful flush to help clean bowl surface
- Metal trip lever
- Metal shank fill valve
- Includes EZ-Install Tools
- EverClean® Antimicrobial Surface
- 16-1/2" (419 mm) rim height for accessible application
- 2-1/8" (54 mm) fully glazed trapway
- 9" x 8" (229 x 203 mm) water surface area
- 3" (76 mm) flush valve
- Five-year warranty

Nominal Dimensions:

28-1/4 in x 18 in x 30-3/8 in (717 mm x 457 mm x 771 mm)



Description	Net Wt	SKU	Color	List Price
Cadet® PRO Two-Piece 1.6 gpf/6.0 Lpf Compact Chair Height Elongated Toilet Less Seat		215FA004.020	White	481
		215FA004.021	Bone	817
		215FA004.222	Linen	817
Separate Components:				
Cadet® PRO Compact Chair Height Elongated Bowl	55 lb 25.0 kg	3517F101.020	White	278
		3517F101.021	Bone	475
		3517F101.222	Linen	475
Cadet® PRO 1.6 gpf/6.0 Lpf 10-Inch Rough Tank	27 lb 12.3 kg	4188B004.020	White	203
		4188B004.021	Bone	342
		4188B004.222	Linen	342
Cadet® PRO 10-Inch Rough Toilet Tank Cover	6 lb 2.9 kg	735173-400.020	White	107
		735173-400.021	Bone	124
		735173-400.222	Linen	124
Left-Hand Trip Lever	0 lb 0.2 kg	▷7381231-200.0020A	Polished Chrome	37
		▷7381231-200.0130A	Polished Nickel	46
		▷7381231-200.0200A	White	45
		▷7381231-200.0990A	Polished Brass	45
		▷7381231-200.2240A	Oil Rubbed Bronze	67
		▷7381231-200.2780A	Legacy Bronze	108
		▷7381231-200.2950A	Brushed Nickel	54
Optional Components:				
Cardiff™ Slow-Close Elongated Toilet Seat	3 lb 1.5 kg	5257A65MT.020	White	71
		5257A65MT.021	Bone	78
		5257A65MT.222	Linen	78

▷ Parts Program

Other seat options

Additional tanks

ADA when installed with provided seat, top of seat is 17" to 19" (432 to 483 mm) from the finished floor.

Meets all ANSI/ASME Low Consumption, Water Conservation Requirements.

✦ Check your local codes to determine if 1.6 gpf/6.0 Lpf toilets are allowed in your area.

Commercial Fixtures

Low Consumption (1.6 gpf/6.0 Lpf) Toilet ✦



Cadet® PRO Two-Piece 1.6 gpf/6.0 Lpf Compact Chair Height Elongated 14-Inch Rough Toilet Less Seat

- Combination bowl and tank, less seat
- Space saving elongated bowl fits in the space of a round front
- 14" (356 mm) rough-in
- Low consumption (1.6 gpf/6.0 Lpf)
- Trade specific tank
- PowerWash® – Powerful flush to help clean bowl surface
- Metal trip lever
- Metal shank fill valve
- Includes EZ-Install Tools
- EverClean® Antimicrobial Surface
- 16-½" (419 mm) rim height for accessible application
- 2-1/8" (54 mm) fully glazed trapway
- 9" x 8" (229 x 203 mm) water surface area
- 3" (76 mm) flush valve
- Five-year warranty

Nominal Dimensions:

30 in x 17-3/8 in x 30-3/8 in (762 mm x 441 mm x 771 mm)



Description	Net Wt	SKU	Color	List Price
Cadet® PRO Two-Piece 1.6 gpf/6.0 Lpf Compact Chair Height Elongated 14-Inch Rough Toilet Less Seat		215FC004.020	White	427
		215FC004.021	Bone	657
		215FC004.222	Linen	657
Separate Components:				
Cadet® PRO Compact Chair Height Elongated Bowl	55 lb 25.0 kg	3517F101.020	White	278
		3517F101.021	Bone	475
		3517F101.222	Linen	475
Cadet® PRO 1.6 gpf/6.0 Lpf 12-Inch Rough Tank	27 lb 12.6 kg	4188A004.020	White	149
		4188A004.021	Bone	182
		4188A004.222	Linen	182
Cadet® PRO 12-Inch Rough Toilet Tank Cover	7 lb 3.3 kg	735172-400.020	White	94
		735172-400.021	Bone	119
		735172-400.222	Linen	119
Left-Hand Trip Lever	0 lb 0.2 kg	▷7381231-200.0020A	Polished Chrome	37
		▷7381231-200.0130A	Polished Nickel	46
	0 lb 0.2 kg	▷7381231-200.0200A	White	45
		▷7381231-200.0990A	Polished Brass	45
	0 lb 0.1 kg	▷7381231-200.2240A	Oil Rubbed Bronze	67
		▷7381231-200.2780A	Legacy Bronze	108
0 lb 0.0 kg	▷7381231-200.2950A	Brushed Nickel	54	
Optional Components:				
Cardiff™ Slow-Close Elongated Toilet Seat	3 lb 1.5 kg	5257A65MT.020	White	71
		5257A65MT.021	Bone	78
		5257A65MT.222	Linen	78

▷ Parts Program

Other seat options

Additional tanks

ADA when installed with provided seat, top of seat is 17" to 19" (432 to 483 mm) from the finished floor.

Meets all ANSI/ASME Low Consumption, Water Conservation Requirements.

✦ Check your local codes to determine if 1.6 gpf/6.0 Lpf toilets are allowed in your area.

Commercial Fixtures

High Efficiency (1.28 gpf/4.8 Lpf) toilets



Cadet® PRO Two-Piece 1.28 gpf/4.8 Lpf Standard Height Elongated Toilet Less Seat

- Combination bowl and tank, less seat
- 12" (305 mm) rough-in
- High efficiency, ultra-low consumption (1.28 gpf/4.8 Lpf), utilizes 20% less water
- Meets EPA WaterSense® criteria
- Trade specific tank
- PowerWash® – Powerful flush to help clean bowl surface
- Metal trip lever
- Metal shank fill valve
- Includes EZ-Install Tools
- EverClean® Antimicrobial Surface
- 2-1/8" (54 mm) fully glazed trapway
- 9" x 8" (229 x 203 mm) water surface area
- 3" (76 mm) flush valve
- Five-year warranty

Nominal Dimensions:

30-1/4 in x 17-1/4 in x 28-7/8 in (768 mm x 438 mm x 733 mm)



Description	Net Wt	SKU	Color	List Price
Cadet® PRO Two-Piece 1.28 gpf/4.8 Lpf Standard Height Elongated Toilet Less Seat		215CA104.020	White	366
		215CA104.021	Bone	451
		215CA104.222	Linen	451

Separate Components:

Cadet® PRO Standard Height Elongated Bowl	50 lb 23.1 kg	3517C101.020	White	217
		3517C101.021	Bone	269
		3517C101.222	Linen	269
Cadet® PRO 1.28 gpf/4.8 Lpf 12-Inch Rough Tank	27 lb 12.6 kg	4188A104.020	White	149
		4188A104.021	Bone	182
		4188A104.222	Linen	182
Cadet® PRO 12-Inch Rough Toilet Tank Cover	7 lb 3.3 kg	735172-400.020	White	94
		735172-400.021	Bone	119
		735172-400.222	Linen	119
Left-Hand Trip Lever	0 lb 0.2 kg	▷7381231-200.0020A	Polished Chrome	37
		▷7381231-200.0130A	Polished Nickel	46
		▷7381231-200.0200A	White	45
		▷7381231-200.0990A	Polished Brass	45
		▷7381231-200.2240A	Oil Rubbed Bronze	67
		▷7381231-200.2780A	Legacy Bronze	108
		▷7381231-200.2950A	Brushed Nickel	54

Optional Components:

Cardiff™ Slow-Close Elongated Toilet Seat	3 lb 1.5 kg	5257A65MT.020	White	71
		5257A65MT.021	Bone	78
		5257A65MT.222	Linen	78

▷ Parts Program

Other seat options

Additional tanks

Meets all ANSI/ASME Low Consumption, Water Conservation Requirements.

Commercial Fixtures

High Efficiency (1.28 gpf/4.8 Lpf) **oilet**



Cadet® PRO Two-Piece 1.28 gpf/4.8 Lpf Standard Height Round Front Toilet Less Seat

- Combination bowl and tank, less seat
- 12" (305 mm) rough-in
- High efficiency, ultra-low consumption (1.28 gpf/4.8 Lpf), utilizes 20% less water
- Meets EPA WaterSense® criteria
- Trade specific tank
- PowerWash® – Powerful flush to help clean bowl surface
- Metal trip lever
- Metal shank fill valve
- Includes EZ-Install Tools
- EverClean® Antimicrobial Surface
- 2-1/8" (54 mm) fully glazed trapway
- 9" x 8" (229 x 203 mm) water surface area
- 3" (76 mm) flush valve
- Five-year warranty

Nominal Dimensions:

28-1/4 in x 17-1/4 in x 28-7/8 in (717 mm x 438 mm x 733 mm)



Description	Net Wt	SKU	Color	List Price
Cadet® PRO Two-Piece 1.28 gpf/4.8 Lpf Standard Height Round Front Toilet Less Seat		215DA104.020	White	325
		215DA104.021	Bone	401
		215DA104.222	Linen	401

Separate Components:

Cadet® PRO Standard Height Round Front Bowl	46 lb 21.3 kg	3517D101.020	White	176
		3517D101.021	Bone	219
		3517D101.222	Linen	219
Cadet® PRO 1.28 gpf/4.8 Lpf 12-Inch Rough Tank	27 lb 12.6 kg	4188A104.020	White	149
		4188A104.021	Bone	182
		4188A104.222	Linen	182
Cadet® PRO 12-Inch Rough Toilet Tank Cover	7 lb 3.3 kg	735172-400.020	White	94
		735172-400.021	Bone	119
		735172-400.222	Linen	119
Left-Hand Trip Lever	0 lb 0.2 kg	▷7381231-200.0020A	Polished Chrome	37
		▷7381231-200.0130A	Polished Nickel	46
		▷7381231-200.0200A	White	45
		▷7381231-200.0990A	Polished Brass	45
		▷7381231-200.2240A	Oil Rubbed Bronze	67
		▷7381231-200.2780A	Legacy Bronze	108
		▷7381231-200.2950A	Brushed Nickel	54

Optional Components:

Cardiff™ Slow-Close Round Front Toilet Seat	3 lb 1.4 kg	5259B65MT.020	White	65
		5259B65MT.021	Bone	71
		5259B65MT.222	Linen	71

▷ Parts Program

Other seat options

Additional tanks

Meets all ANSI/ASME Low Consumption, Water Conservation Requirements.

Commercial Fixtures

Low Consumption (1.6 gpf/6.0 Lpf) Toilet ✦



Cadet® PRO Two-Piece 1.6 gpf/6.0 Lpf Standard Height Elongated Toilet Less Seat

- Combination bowl and tank, less seat
- 12" (305 mm) rough-in
- Low consumption (1.6 gpf/6.0 Lpf)
- Trade specific tank
- PowerWash® – Powerful flush to help clean bowl surface
- Metal trip lever
- Metal shank fill valve
- Includes EZ-Install Tools
- EverClean® Antimicrobial Surface
- 2-1/8" (54 mm) fully glazed trapway
- 9" x 8" (229 x 203 mm) water surface area
- 3" (76 mm) flush valve
- Five-year warranty

Nominal Dimensions:

30-1/4 in x 17-1/4 in x 28-7/8 in (768 mm x 438 mm x 733 mm)

Description	Net Wt	SKU	Color	List Price
Cadet® PRO Two-Piece 1.6 gpf/6.0 Lpf Standard Height Elongated Toilet Less Seat		215CA004.020	White	366
		215CA004.021	Bone	451
		215CA004.222	Linen	451

Separate Components:

Cadet® PRO Standard Height Elongated Bowl	50 lb 23.1 kg	3517C101.020	White	217
		3517C101.021	Bone	269
		3517C101.222	Linen	269
Cadet® PRO 1.6 gpf/6.0 Lpf 12-Inch Rough Tank	27 lb 12.6 kg	4188A004.020	White	149
		4188A004.021	Bone	182
		4188A004.222	Linen	182
Cadet® PRO 12-Inch Rough Toilet Tank Cover	7 lb 3.3 kg	735172-400.020	White	94
		735172-400.021	Bone	119
		735172-400.222	Linen	119
Left-Hand Trip Lever	0 lb 0.2 kg	▷7381231-200.0020A	Polished Chrome	37
		▷7381231-200.0130A	Polished Nickel	46
	0 lb 0.2 kg	▷7381231-200.0200A	White	45
		▷7381231-200.0990A	Polished Brass	45
		▷7381231-200.2240A	Oil Rubbed Bronze	67
	0 lb 0.1 kg	▷7381231-200.2780A	Legacy Bronze	108
	0 lb 0.0 kg	▷7381231-200.2950A	Brushed Nickel	54

Optional Components:

Cardiff™ Slow-Close Elongated Toilet Seat	3 lb 1.5 kg	5257A65MT.020	White	71
		5257A65MT.021	Bone	78
		5257A65MT.222	Linen	78

▷ Parts Program

Other seat options

Additional tanks

ADA when installed with provided seat, top of seat is 17" to 19" (432 to 483 mm) from the finished floor.

Meets all ANSI/ASME Low Consumption, Water Conservation Requirements.

✦ Check your local codes to determine if 1.6 gpf/6.0 Lpf toilets are allowed in your area.

Commercial Fixtures

Low Consumption (1.6 gpf/6.0 Lpf) Toilet ✦



Cadet® PRO Two-Piece 1.6 gpf/6.0 Lpf Standard Height Round Front Toilet Less Seat

- Combination bowl and tank, less seat
- 12" (305 mm) rough-in
- Low consumption (1.6 gpf/6.0 Lpf)
- Trade specific tank
- PowerWash® – Powerful flush to help clean bowl surface
- Metal trip lever
- Metal shank fill valve
- Includes EZ-Install Tools
- EverClean® Antimicrobial Surface
- 2-1/8" (54 mm) fully glazed trapway
- 9" x 8" (229 x 203 mm) water surface area
- 3" (76 mm) flush valve
- Five-year warranty
- Round Front Toilet Less Seat

Nominal Dimensions:

28-1/4 in x 17-1/4 in x 28-7/8 in (717 mm x 438 mm x 733 mm)

Description	Net Wt	SKU	Color	List Price
Cadet® PRO Two-Piece 1.6 gpf/6.0 Lpf Standard Height Round Front Toilet Less Seat		215DA004.020	White	325
		215DA004.021	Bone	401
		215DA004.222	Linen	401

Separate Components:

Cadet® PRO Standard Height Round Front Bowl	46 lb 21.3 kg	3517D101.020	White	176
		3517D101.021	Bone	219
		3517D101.222	Linen	219
Cadet® PRO 1.6 gpf/6.0 Lpf 12-Inch Rough Tank	27 lb 12.6 kg	4188A004.020	White	149
		4188A004.021	Bone	182
		4188A004.222	Linen	182
Cadet® PRO 12-Inch Rough Toilet Tank Cover	7 lb 3.3 kg	735172-400.020	White	94
		735172-400.021	Bone	119
		735172-400.222	Linen	119
Left-Hand Trip Lever	0 lb 0.2 kg	▷7381231-200.0020A	Polished Chrome	37
		▷7381231-200.0130A	Polished Nickel	46
		▷7381231-200.0200A	White	45
		▷7381231-200.0990A	Polished Brass	45
		▷7381231-200.2240A	Oil Rubbed Bronze	67
		▷7381231-200.2780A	Legacy Bronze	108
		▷7381231-200.2950A	Brushed Nickel	54

Optional Components:

Cardiff™ Slow-Close Round Front Toilet Seat	3 lb 1.4 kg	5259B65MT.020	White	65
		5259B65MT.021	Bone	71
		5259B65MT.222	Linen	71

▷ Parts Program
Other seat options
Additional tanks

Meets all ANSI/ASME Low Consumption, Water Conservation Requirements.

✦ Check your local codes to determine if 1.6 gpf/6.0 Lpf toilets are allowed in your area.

Commercial Fixtures

High Efficiency (1.28 gpf/4.8 Lpf) **oilet**



Cadet® PRO Two-Piece 1.28 gpf/4.8 Lpf Standard Height Round Front 10-Inch Rough Toilet Less Seat

- Combination bowl and tank, less seat
- 10" (254 mm) rough-in
- High efficiency, ultra-low consumption (1.28 gpf/4.8 Lpf), utilizes 20% less water
- Meets EPA WaterSense® criteria
- Trade specific tank
- PowerWash® – Powerful flush to help clean bowl surface
- Metal trip lever
- Metal shank fill valve
- Includes EZ-Install Tools
- EverClean® Antimicrobial Surface
- 2-1/8" (54 mm) fully glazed trapway
- 9" x 8" (229 x 203 mm) water surface area
- 3" (76 mm) flush valve
- Five-year warranty
- Round Front Toilet Less Seat

Nominal Dimensions:

26-1/4 in x 18 in x 29 in (666 mm x 457 mm x 736 mm)



Description	Net Wt	SKU	Color	List Price
Cadet® PRO Two-Piece 1.28 gpf/4.8 Lpf Standard Height Round Front 10-Inch Rough Toilet Less Seat		215DB104.020	White	379
		215DB104.021	Bone	561
		215DB104.222	Linen	561

Separate Components:

Cadet® PRO Standard Height Round Front Bowl	46 lb 21.3 kg	3517D101.020	White	176
		3517D101.021	Bone	219
		3517D101.222	Linen	219
Cadet® PRO 1.28 gpf/4.8 Lpf 10-Inch Rough Tank	27 lb 12.3 kg	4188B104.020	White	203
		4188B104.021	Bone	342
		4188B104.222	Linen	342
Cadet® PRO 10-Inch Rough Toilet Tank Cover	6 lb 2.9 kg	735173-400.020	White	107
		735173-400.021	Bone	124
		735173-400.222	Linen	124
Left-Hand Trip Lever	0 lb 0.2 kg	▷7381231-200.0020A	Polished Chrome	37
		▷7381231-200.0130A	Polished Nickel	46
		▷7381231-200.0200A	White	45
		▷7381231-200.0990A	Polished Brass	45
		▷7381231-200.2240A	Oil Rubbed Bronze	67
		▷7381231-200.2780A	Legacy Bronze	108
		▷7381231-200.2950A	Brushed Nickel	54

Optional Components:

Cardiff™ Slow-Close Round Front Toilet Seat	3 lb 1.4 kg	5259B65MT.020	White	65
		5259B65MT.021	Bone	71
		5259B65MT.222	Linen	71

▷ Parts Program

Other seat options

Additional tanks

Meets all ANSI/ASME Low Consumption, Water Conservation Requirements.

Commercial Fixtures

Low Consumption (1.6 gpf/6.0 Lpf) Toilets ✦



Cadet® PRO Two-Piece 1.6 gpf/6.0 Lpf Standard Height Elongated 10-Inch Rough Toilet Less Seat

- Combination bowl and tank, less seat
- 10" (254 mm) rough-in
- Low consumption (1.6 gpf/6.0 Lpf)
- Trade specific tank
- PowerWash® – Powerful flush to help clean bowl surface
- Metal trip lever
- Metal shank fill valve
- Includes EZ-Install Tools
- EverClean® Antimicrobial Surface
- 2-1/8" (54 mm) fully glazed trapway
- 9" x 8" (229 x 203 mm) water surface area
- 3" (76 mm) flush valve
- Five-year warranty

Nominal Dimensions:

28-1/2 in x 18 in x 29 in (723 mm x 457 mm x 736 mm)

Description	Net Wt	SKU	Color	List Price
Cadet® PRO Two-Piece 1.6 gpf/6.0 Lpf Standard Height Elongated 10-Inch Rough Toilet Less Seat		215CB004.020	White	420
		215CB004.021	Bone	611
		215CB004.222	Linen	611

Separate Components:

Cadet® PRO Standard Height Elongated Bowl	50 lb 23.1 kg	3517C101.020	White	217
		3517C101.021	Bone	269
		3517C101.222	Linen	269
Cadet® PRO 1.6 gpf/6.0 Lpf 10-Inch Rough Tank	27 lb 12.3 kg	4188B004.020	White	203
		4188B004.021	Bone	342
		4188B004.222	Linen	342
Cadet® PRO 10-Inch Rough Toilet Tank Cover	6 lb 2.9 kg	735173-400.020	White	107
		735173-400.021	Bone	124
		735173-400.222	Linen	124
Left-Hand Trip Lever	0 lb 0.2 kg	▷7381231-200.0020A	Polished Chrome	37
		▷7381231-200.0130A	Polished Nickel	46
		▷7381231-200.0200A	White	45
		▷7381231-200.0990A	Polished Brass	45
		▷7381231-200.2240A	Oil Rubbed Bronze	67
		▷7381231-200.2780A	Legacy Bronze	108
		▷7381231-200.2950A	Brushed Nickel	54

Optional Components:

Cardiff™ Slow-Close Elongated Toilet Seat	3 lb 1.5 kg	5257A65MT.020	White	71
		5257A65MT.021	Bone	78
		5257A65MT.222	Linen	78

▷ Parts Program

Other seat options

Additional tanks

Meets all ANSI/ASME Low Consumption, Water Conservation Requirements.

✦ Check your local codes to determine if 1.6 gpf/6.0 Lpf toilets are allowed in your area.

Commercial Fixtures

Low Consumption (1.6 gpf/6.0 Lpf) Toilet ✦



Cadet® PRO Two-Piece 1.6 gpf/6.0 Lpf Standard Height Round Front 10-Inch Rough Toilet Less Seat

- Combination bowl and tank, less seat
- 10" (254 mm) rough-in
- Low consumption (1.6 gpf/6.0 Lpf)
- Trade specific tank
- PowerWash® – Powerful flush to help clean bowl surface
- Metal trip lever
- Metal shank fill valve
- Includes EZ-Install Tools
- EverClean® Antimicrobial Surface
- 2-1/8" (54 mm) fully glazed trapway
- 9" x 8" (229 x 203 mm) water surface area
- 3" (76 mm) flush valve
- Five-year warranty
- Round Front Toilet Less Seat

Nominal Dimensions:

26-1/4 in x 18 in x 29 in (666 mm x 457 mm x 736 mm)

Description	Net Wt	SKU	Color	List Price
Cadet® PRO Two-Piece 1.6 gpf/6.0 Lpf Standard Height Round Front 10-Inch Rough Toilet Less Seat		215DB004.020	White	379
		215DB004.021	Bone	561
		215DB004.222	Linen	561

Separate Components:

Cadet® PRO Standard Height Round Front Bowl	46 lb 21.3 kg	3517D101.020	White	176
		3517D101.021	Bone	219
		3517D101.222	Linen	219
Cadet® PRO 1.6 gpf/6.0 Lpf 10-Inch Rough Tank	27 lb 12.3 kg	4188B004.020	White	203
		4188B004.021	Bone	342
		4188B004.222	Linen	342
Cadet® PRO 10-Inch Rough Toilet Tank Cover	6 lb 2.9 kg	735173-400.020	White	107
		735173-400.021	Bone	124
		735173-400.222	Linen	124
Left-Hand Trip Lever	0 lb 0.2 kg	▷7381231-200.0020A	Polished Chrome	37
		▷7381231-200.0130A	Polished Nickel	46
		▷7381231-200.0200A	White	45
		▷7381231-200.0990A	Polished Brass	45
		▷7381231-200.2240A	Oil Rubbed Bronze	67
		▷7381231-200.2780A	Legacy Bronze	108
		▷7381231-200.2950A	Brushed Nickel	54

Optional Components:

Cardiff™ Slow-Close Round Front Toilet Seat	3 lb 1.4 kg	5259B65MT.020	White	65
		5259B65MT.021	Bone	71
		5259B65MT.222	Linen	71

▷ Parts Program

Other seat options

Additional tanks

Meets all ANSI/ASME Low Consumption, Water Conservation Requirements.

✦ Check your local codes to determine if 1.6 gpf/6.0 Lpf toilets are allowed in your area.

Commercial Fixtures

Toilet Seats



Cadet® 3 Slow-Close Elongated Toilet Seat

- "No Slam" slow-close seat and lid for user convenience
- EverClean® Antimicrobial Surface
- Sanitary lift tab allows user to raise the seat with ease
- Fits most conventional elongated toilets
- Bottom mounting hardware included
- Made from Polypropylene Plastic
- Traditional design

Nominal Dimensions:

18-13/16 in x 14-7/16 in x 2-3/16 in (477 mm x 366 mm x 55 mm)

Description	Net Wt	SKU	Color	List Price
Cadet® 3 Slow-Close Elongated Toilet Seat	4 lb 2.0 kg	5350110.020	White	81
		5350110.021	Bone	110
		5350110.222	Linen	110

Separate Components:

Bottom Mount Seat Mounting Kit	0 lb 0.0 kg	▷760087-0070A	No Finish	9
--------------------------------	----------------	---------------	-----------	---



Cadet® 3 Slow-Close Round Front Toilet Seat

- "No Slam" slow-close seat & lid for user convenience
- EverClean® Antimicrobial Surface
- Sanitary lift tab allows user to raise the seat with ease
- Fits most conventional round front toilets
- Bottom mounting hardware included
- Made from Polypropylene Plastic
- Traditional design

Nominal Dimensions:

16-11/16 in x 14-3/16 in x 2-1/4 in (423 mm x 360 mm x 57 mm)

Description	Net Wt	SKU	Color	List Price
Cadet® 3 Slow-Close Round Front Toilet Seat	3 lb 1.7 kg	5345110.020	White	79
		5345110.021	Bone	104
		5345110.222	Linen	104

Separate Components:

Bottom Mount Seat Mounting Kit	0 lb 0.0 kg	▷760087-0070A	No Finish	9
--------------------------------	----------------	---------------	-----------	---



Cardiff™ Slow-Close Elongated Toilet Seat

- "No Slam" slow-close seat and lid for user convenience
- EverClean® Antimicrobial Surface
- Fits most conventional elongated toilets
- Bottom mounting hardware with Quick connect nut included to expedite installation
- Made from Polypropylene Plastic

Nominal Dimensions:

18-11/16 in x 13-7/8 in x 2-1/4 in (474 mm x 352 mm x 57 mm)

Description	Net Wt	SKU	Color	List Price
Cardiff™ Slow-Close Elongated Toilet Seat	3 lb 1.5 kg	5257A65MT.020	White	71
		5257A65MT.021	Bone	78
		5257A65MT.222	Linen	78

Separate Components:

Bottom Mount Seat Mounting Kit	0 lb 0.0 kg	▷760219-100.0070A	No Finish	6
--------------------------------	----------------	-------------------	-----------	---

▷ Parts Program

Commercial Fixtures

Toilet Seats



Cardiff™ Slow-Close Round Front Toilet Seat

- "No Slam" slow-close seat & lid for user convenience
- EverClean® Antimicrobial Surface
- Fits most conventional round front toilets
- Bottom mounting hardware with Quick connect nut included to expedite installation
- Made from Polypropylene Plastic

Nominal Dimensions:

16-5/8 in x 14-3/16 in x 2-1/4 in (422 mm x 360 mm x 57 mm)

Description	Net Wt	SKU	Color	List Price
Cardiff™ Slow-Close Round Front Toilet Seat	3 lb 1.4 kg	5259B65MT.020	White	65
		5259B65MT.021	Bone	71
		5259B65MT.222	Linen	71

Separate Components:

Bottom Mount Seat Mounting Kit	0 lb 0.0 kg	▷760219-100.0070A	No Finish	6
--------------------------------	----------------	-------------------	-----------	---



Champion® Slow-Close & Easy Lift-Off Elongated Toilet Seat

- "No Slam" slow-close seat and lid for user convenience
- Lift to release Easy Clean hinge for easier cleaning of the seat & bowl – No Tools Required
- EverClean® Antimicrobial Surface
- Fits most conventional elongated toilets
- Bottom mounting hardware included
- Made from Polypropylene Plastic
- Attractive design coordinates with popular bathroom decor

Nominal Dimensions:

18-11/16 in x 14-1/16 in x 2-5/16 in (474 mm x 357 mm x 58 mm)

Description	Net Wt	SKU	Color	List Price
Champion® Slow-Close & Easy Lift-Off Elongated Toilet Seat	3 lb 1.6 kg	5321A65CT.020	White	98
		5321A65CT.021	Bone	123
		5321A65CT.222	Linen	123

Separate Components:

Bottom Mount Seat Mounting Kit	0 lb 0.0 kg	▷760219-100.0070A	No Finish	6
--------------------------------	----------------	-------------------	-----------	---



Champion® Slow-Close & Easy Lift-Off Round Front Toilet Seat

- "No Slam" slow-close seat & lid for user convenience
- Lift to release Easy Clean hinge for easier cleaning of the seat & bowl – No Tools Required
- EverClean® Antimicrobial Surface
- Fits most conventional round front toilets
- Bottom mounting hardware included
- Made from Polypropylene Plastic
- Attractive design coordinates with popular bathroom decor

Nominal Dimensions:

16-13/16 in x 14-5/16 in x 2-5/16 in (427 mm x 363 mm x 58 mm)

Description	Net Wt	SKU	Color	List Price
Champion® Slow-Close & Easy Lift-Off Round Front Toilet Seat	3 lb 1.4 kg	5320B65CT.020	White	83
		5320B65CT.021	Bone	110
		5320B65CT.222	Linen	110

Separate Components:

Bottom Mount Seat Mounting Kit	0 lb 0.0 kg	▷760219-100.0070A	No Finish	6
--------------------------------	----------------	-------------------	-----------	---

▷ Parts Program

Commercial Fixtures

Toilet Seats



Commercial Heavy Duty Open Front Elongated Toilet Seat

- Elongated Open Front toilet seat
- Without seat lid cover
- Engineered with stainless steel check hinges
- Tested for 500 lb static weight load
- Fits most conventional elongated commercial toilets
- Bottom mounting hardware included
- Made from Polypropylene Plastic

Nominal Dimensions:

19-3/8 in x 14-1/2 in x 2-3/8 in (492 mm x 368 mm x 60 mm)

Description	Net Wt	SKU	Color	List Price
Commercial Heavy Duty Open Front Elongated Toilet Seat	3 lb 1.4 kg	5901100.020	White	34

Separate Components:

5901 Series Seat Mounting Kit	0 lb 0.2 kg	▷760222-100.0070A	No Finish	12
-------------------------------	----------------	-------------------	-----------	----



Commercial Heavy Duty Open Front Elongated Toilet Seat with EverClean® Surface and Self-sustaining Hinges

- Elongated Open Front Toilet Seat
- Without seat lid cover
- EverClean® Antimicrobial Surface inhibits the growth of stain and odor causing bacteria, mold and mildew. Does not protect against disease causing bacteria
- Engineered with stainless steel self-sustaining hinges
- Tested for 500 lb static weight load
- Fits most conventional elongated commercial toilets
- Bottom Mounting Hardware Included
- Made from Polypropylene Plastic

Nominal Dimensions:

19-3/8 in x 14-1/2 in x 2-3/8 in (492 mm x 368 mm x 60 mm)

Description	Net Wt	SKU	Color	List Price
Commercial Heavy Duty Open Front Elongated Toilet Seat with EverClean® Surface and Self-sustaining Hinges	2 lb 1.1 kg	5901100SS.020	White	40

Separate Components:

5901 Series Seat Mounting Kit	0 lb 0.2 kg	▷760222-100.0070A	No Finish	12
-------------------------------	----------------	-------------------	-----------	----



Commercial Heavy Duty Open Front Elongated Toilet Seat With EverClean® Surface

- Elongated Open Front Toilet Seat
- Without seat lid cover
- EverClean® Antimicrobial Surface inhibits the growth of stain and odor causing bacteria, mold and mildew. Does not protect against disease causing bacteria
- Engineered with stainless steel check hinges
- Tested for 500 lb static weight load
- Fits most conventional elongated commercial toilets
- Bottom Mounting Hardware Included
- Made from Polypropylene Plastic

Nominal Dimensions:

19-3/8 in x 14-1/2 in x 2-3/8 in (492 mm x 368 mm x 60 mm)

Description	Net Wt	SKU	Color	List Price
Commercial Heavy Duty Open Front Elongated Toilet Seat With EverClean® Surface	2 lb 1.3 kg	5901110T.020	White	43

Separate Components:

5901 Series Seat Mounting Kit	0 lb 0.2 kg	▷760222-100.0070A	No Finish	12
-------------------------------	----------------	-------------------	-----------	----

▷ Parts Program

Commercial Fixtures

Toilet Seats



Contemporary Slow-Close & Easy Lift-Off Elongated Toilet Seat for VorMax® CleanCurve® Style Rims

- "No Slam" slow-close seat and lid for user convenience
- Lift to release Easy Clean hinge for easier cleaning of the seat & bowl – No Tools Required
- Ever-Tite® locking hinge system, engineered to reduce the seat from shifting side to side
- EverClean® Antimicrobial Surface
- Sanitary lift tab allows user to raise the seat with ease
- Fits elongated VorMax® CleanCurve® style rim toilets
- Unique bumpers designed for added stability to reduce movement of the seat
- Bottom mounting hardware included
- Made from Polypropylene Plastic
- Easy Close, Easy Lift, Easy Clean

Nominal Dimensions:

18-3/16 in x 14-3/4 in x 2 in (461 mm x 374 mm x 50 mm)

Description	Net Wt	SKU	Color	List Price
Contemporary Slow-Close & Easy Lift-Off Elongated Toilet Seat for VorMax® CleanCurve® Style Rims	3 lb	5055A65C.020	White	108
	1.7 kg	5055A65C.021	Bone	120
		5055A65C.222	Linen	141

Separate Components:

Seat Mounting Kit	0 lb	▷760218-101.0210A	Bone	8
	0.1 kg	▷760218-101.2220A	Linen	8



Contemporary Slow-Close & Easy Lift-Off Elongated Toilet Seat

- "No Slam" slow-close seat and lid for user convenience
- Lift to release Easy Clean hinge for easier cleaning of the seat & bowl – No Tools Required
- Ever-Tite® locking hinge system, engineered to reduce the seat from shifting side to side
- EverClean® Antimicrobial Surface
- Sanitary lift tab allows user to raise the seat with ease
- Fits most conventional elongated toilets
- Flat bumpers designed for universal fit
- Bottom mounting hardware included
- Made from Polypropylene Plastic
- Easy Close, Easy Lift, Easy Clean

Nominal Dimensions:

18-3/16 in x 14-3/4 in x 2 in (461 mm x 374 mm x 50 mm)

Description	Net Wt	SKU	Color	List Price
Contemporary Slow-Close & Easy Lift-Off Elongated Toilet Seat	3 lb	5055A65PT.020	White	107
	1.7 kg	5055A65PT.021	Bone	114
		5055A65PT.222	Linen	114

Separate Components:

Seat Mounting Kit	0 lb	▷760218-101.0210A	Bone	8
	0.1 kg	▷760218-101.2220A	Linen	8

Commercial Fixtures

Toilet Seats



Contemporary Slow-Close & Easy Lift-Off Round Front Toilet Seat

- "No Slam" slow-close seat & lid for user convenience
- Lift to release Easy Clean hinge for easier cleaning of the seat & bowl – No Tools Required
- Ever-Tite® locking hinge system, engineered to reduce the seat from shifting side to side
- EverClean® Antimicrobial Surface
- Sanitary lift tab allows user to raise the seat with ease
- Fits most conventional round front toilets
- Flat bumpers designed for universal fit
- Bottom mounting hardware included
- Made from Polypropylene Plastic
- Easy Close, Easy Lift, Easy Clean

Nominal Dimensions:

16-15/16 in x 14-3/4 in x 1-15/16 in (430 mm x 374 mm x 49 mm)

Description	Net Wt	SKU	Color	List Price
Contemporary Slow-Close & Easy Lift-Off Round Front Toilet Seat	3 lb	5055B65PT.020	White	99
	1.5 kg	5055B65PT.021	Bone	107
		5055B65PT.222	Linen	107

Separate Components:

Seat Mounting Kit	0 lb	▷760218-101.0210A	Bone	8
	0.1 kg	▷760218-101.2220A	Linen	8



Laurel Elongated Wood Toilet Seat

- High-gloss, molded wood seat and cover
- Color-matched hinges
- Fits most conventional elongated toilets
- Bottom mounting hardware included

Nominal Dimensions:

18-3/4 in x 13-7/8 in x 2-1/2 in (476 mm x 352 mm x 63 mm)

Description	Net Wt	SKU	Color	List Price
Laurel Elongated Wood Toilet Seat	7 lb 3.2 kg	5311012.020	White	53



Transitional Slow-Close Elongated Toilet Seat

- "No Slam" slow-close seat & lid for user convenience
- Fits most conventional elongated toilets
- Bottom mounting hardware included
- Made from Polypropylene Plastic
- Transitional design

Nominal Dimensions:

18-5/8 in x 14-3/16 in x 1-5/8 in (473 mm x 360 mm x 41 mm)



Description	Net Wt	SKU	Color	List Price
Transitional Slow-Close Elongated Toilet Seat	2 lb 1.3 kg	5503A00B.020	White	57
		5503A00B.021	Bone	53
		5503A00B.222	Linen	57

Separate Components:

Bottom Mount Seat Mounting Kit	0 lb 0.0 kg	▷760225-100.0070A	No Finish	6
--------------------------------	----------------	-------------------	-----------	---

Commercial Fixtures

Toilet Seats



Transitional Slow-Close Round-Front Toilet Seat

- "No Slam" slow-close seat & lid for user convenience
- Fits most conventional round front toilets
- Bottom mounting hardware included
- Made from Polypropylene Plastic
- Transitional design

Nominal Dimensions:

16-5/8 in x 14-3/16 in x 1-5/8 in (422 mm x 360 mm x 41 mm)



Description	Net Wt	SKU	Color	List Price
Transitional Slow-Close Round-Front Toilet Seat	2 lb 1.2 kg	5503B00B.020	White	51

Separate Components:

Bottom Mount Seat Mounting Kit	0 lb 0.0 kg	▶760225-100.0070A	No Finish	6
--------------------------------	----------------	-------------------	-----------	---

▶ Parts Program

Commercial Fixtures

Toilet Trip Levers



Left-Hand Trip Lever

- Left-hand trip lever for Champion® PRO 4225A tank
- Metal lever handle
- Brass arm
- Specify color when ordering
- Kit consists of handle, nut and arm
- One-year warranty

Nominal Dimensions:

5.3 in x 6.8 in x 3.2 in (134 mm x 172 mm x 81 mm)

Description	Net Wt	SKU	Color	List Price
Left-Hand Trip Lever	0 lb 0.2 kg	▷7381232-200.0020A	Polished Chrome	42
	0 lb 0.1 kg	▷7381232-200.0130A	Polished Nickel	46
	0 lb 0.2 kg	▷7381232-200.0200A	White	52
		▷7381232-200.2240A	Oil Rubbed Bronze	103
	0 lb 0.1 kg	▷7381232-200.2780A	Legacy Bronze	78
	0 lb 0.2 kg	▷7381232-200.2950A	Brushed Nickel	55



Left-Hand Trip Lever

- Left-hand trip lever assembly for Cadet® PRO tanks 4188A and 4188B
- Metal lever handle
- Metal arm
- Specify color when ordering
- Kit consists of handle, nut and arm
- One-year warranty



Nominal Dimensions:

5.7 in x 7.6 in x 2.8 in (144 mm x 193 mm x 71 mm)

Description	Net Wt	SKU	Color	List Price
Left-Hand Trip Lever	0 lb 0.2 kg	▷7381231-200.0020A	Polished Chrome	37
	0 lb 0.1 kg	▷7381231-200.0130A	Polished Nickel	46
	0 lb 0.2 kg	▷7381231-200.0200A	White	45
		▷7381231-200.0990A	Polished Brass	45
		▷7381231-200.2240A	Oil Rubbed Bronze	67
	0 lb 0.1 kg	▷7381231-200.2780A	Legacy Bronze	108
	0 lb 0.0 kg	▷7381231-200.2950A	Brushed Nickel	54

Commercial Fixtures

Optional Toilet Tanks ✦

	Description	Net Wt	Pts	SKU	Color	List Price
 Champion® PRO	Champion® PRO 1.6 gpf/6.0 Lpf 12-Inch Rough Tank with TCLD	31 lb 14.1 kg	.76	4225A064.020	White	336
	Champion® PRO 1.28 gpf/4.8 Lpf 12-Inch Rough Lined Tank	31 lb 14.3 kg		4225A154.020	White	273
	Champion® PRO 1.28 gpf/4.8 Lpf Toilet Tank with Tank Cover Locking Device			4225A164.020	White	336
	Champion® PRO 1.28 gpf/4.8 Lpf Toilet Tank with Aquaguard Liner and Tank Cover Locking Device			4225A174.020	White	410
 Cadet® PRO	Cadet® PRO 1.6 gpf/6.0 Lpf 12-Inch Rough Lined Tank	27 lb 12.6 kg	.76	4188A054.020	White	231
				4188A054.021	Bone	287
				4188A054.222	Linen	287
	Cadet® PRO 1.6 gpf/6.0 Lpf 12-Inch Toilet Tank with Tank Cover Locking Device			4188A064.020	White	202
	Cadet® PRO 1.6 gpf/6.0 Lpf 12-Inch Toilet Tank with Tank Cover Locking Device and Right Hand Trip Lever			4188A065.020	White	208
	Cadet® PRO 1.6 gpf/6.0 Lpf 12-Inch Toilet Tank with Aquaguard Liner and Tank Cover Locking Device			4188A074.020	White	280
	Cadet® PRO 1.28 gpf/4.8 Lpf 12-Inch Rough Lined Tank			4188A154.020	White	231
				4188A154.021	Bone	287
				4188A154.222	Linen	287
	Cadet® PRO 1.28 gpf/4.8 Lpf 12-Inch Toilet Tank with Aquaguard Liner and Right Hand Trip Lever			4188A155.020	White	275
	Cadet® PRO 1.28 gpf/4.8 Lpf 12-Inch Toilet Tank with Tank Cover Locking Device			4188A164.020	White	202
	Cadet® PRO 1.28 gpf/4.8 Lpf 12-Inch Toilet Tank with Tank Cover Locking Device and Right Hand Trip Lever			4188A165.020	White	208
	Cadet® PRO 1.28 gpf/4.8 Lpf 12-Inch Toilet Tank with Aquaguard Liner and Tank Cover Locking Device			4188A174.020	White	280
	Cadet® PRO 1.28 gpf/4.8 Lpf 12-Inch Rough Tank			4188A104.020	White	149
				4188A104.021	Bone	182
			4188A104.222	Linen	182	

Toilet Trip Levers

▷ Parts Program

✦ Check your local code to determine if 1.6 gpf/6.0 Lpf toilets are allowed in your area.

Commercial Fixtures

High Efficiency Urinals Operate at 0.125 – 0.5 gpf (0.47 – 1.9 Lpf)



Greenbrook® 0.125 – 0.5 gpf (0.47 – 1.9 Lpf) Top Spud Urinal With EverClean®

- Highly aesthetic vitreous china urinal with large footprint
- High Efficiency Urinal (HEU) operates in the range of 0.125 gpf – 0.5 gpf (0.47 Lpf – 1.9 Lpf)
- Urinal has optimized surface contours and water flushing spreader that rinses inverted back wall for superior splash protection
- EverClean® Antimicrobial Surface inhibits the growth of stain and odor causing bacteria, mold and mildew on the surface
- ¾" (19 mm) inlet spud with 2" (51 mm) threaded outlet connection
- Two wall hangers included
- Fixture only
- Chrome plated non-metallic strainer included.

Nominal Dimensions:

15 in x 16-1/8 in x 27-1/2 in (381 mm x 409 mm x 698 mm)



Description	Net Wt	SKU	Color	List Price
Greenbrook® 0.125 – 0.5 gpf (0.47 – 1.9 Lpf) Top Spud Urinal With EverClean®	70 lb 32.1 kg	6516002EC.020	White	799

Optional Components:

Vandal-Resistant Stainless Steel Strainer	0 lb 0.2 kg	▷7381755-200.0020A	Polished Chrome	32
---	----------------	--------------------	-----------------	----



Greenbrook® 0.125 – 0.5 gpf (0.47 – 1.9 Lpf) Back Spud Urinal with EverClean®

- Highly aesthetic vitreous china urinal with large footprint
- High Efficiency Urinal (HEU) operates in the range of 0.125 gpf – 0.5 gpf (0.47 Lpf – 1.9 Lpf)
- Urinal has optimized surface contours and water flushing spreader that rinses inverted back wall for superior splash protection
- EverClean® Antimicrobial Surface inhibits the growth of stain and odor causing bacteria, mold and mildew on the surface
- ¾" (19 mm) inlet spud with 2" (51 mm) threaded outlet connection
- Two wall hangers included
- Fixture only
- Chrome plated non-metallic strainer included

Nominal Dimensions:

15 in x 16-1/8 in x 27-1/2 in (381 mm x 409 mm x 698 mm)



Description	Net Wt	SKU	Color	List Price
Greenbrook® 0.125 – 0.5 gpf (0.47 – 1.9 Lpf) Back Spud Urinal With EverClean®	70 lb 32.1 kg	6517001EC.020	White	799

Separate Components:

Chrome Plated Non-Metallic Strainer	0 lb 0.0 kg	▷7301242-100.0020A	Polished Chrome	28
-------------------------------------	----------------	--------------------	-----------------	----

Optional Components:

Vandal-Resistant Stainless Steel Strainer	0 lb 0.2 kg	▷7381755-200.0020A	Polished Chrome	32
---	----------------	--------------------	-----------------	----

▷ Parts Program

ADA – Mount top of front rim at 17" (432 mm) maximum from the finished floor

Meets all ANSI/ASME Low Consumption, Water Conservation Requirements.

High Efficiency Urinal (HEU) utilizes 87% less water than traditional 1.0 gpf/3.8 Lpf urinals at 0.125 gpf/0.47 Lpf.

Commercial Fixtures

High Efficiency Urinals Operate at 0.125 gpf/0.47 Lp



Decorum® 0.125 gpf/0.47 Lpf Top Spud Urinal With EverClean®

- Sleek, modern, compact design
- High efficiency (0.125 gpf/0.47 Lpf)
- EverClean® Antimicrobial Surface inhibits the growth of stain and odor causing bacteria, mold and mildew on the surface
- Powerful washdown action
- Deep sump helps reduce splashing
- ¾" (19 mm) inlet spud with 2" (51 mm) threaded outlet connection
- Two wall hangers included
- Fixture only
- Chrome plated non-metallic strainer included

Nominal Dimensions:

14 in x 13-5/16 in x 21-1/2 in (355 mm x 338 mm x 546 mm)



Description	Net Wt	SKU	Color	List Price
Decorum® 0.125 gpf/0.47 Lpf Top Spud Urinal With EverClean®	40 lb 18.4 kg	6042001EC.020	White	274

Separate Components:

K-2 Wall Hanger Bracket	0 lb 0.1 kg	▷047058-0070A	No Finish	7
Chrome Plated Non-Metallic Strainer	0 lb 0.0 kg	▷7301242-100.0020A	Polished Chrome	28

Optional Components:

Vandal-Resistant Stainless Steel Strainer	0 lb 0.2 kg	▷7381755-200.0020A	Polished Chrome	32
---	----------------	--------------------	-----------------	----



Decorum® 0.125 gpf/0.47 Lpf Back Spud Urinal With EverClean®

- Sleek, modern, compact design
- Vitreous china
- High efficiency (0.125 gpf/0.47 Lpf)
- EverClean® Antimicrobial Surface inhibits the growth of stain and odor causing bacteria, mold and mildew on the surface
- Powerful washdown action
- Deep sump helps reduce splashing
- ¾" (19 mm) inlet spud with 2" (51 mm) outlet spud
- Two wall hangers included
- Fixture only
- Chrome plated non-metallic strainer included.

Nominal Dimensions:

14 in x 13-5/16 in x 21-1/2 in (355 mm x 338 mm x 546 mm)



Description	Net Wt	SKU	Color	List Price
Decorum® 0.125 gpf/0.47 Lpf Back Spud Urinal With EverClean®	40 lb 18.4 kg	6043001EC.020	White	284

Separate Components:

K-2 Wall Hanger Bracket	0 lb 0.1 kg	▷047058-0070A	No Finish	7
Chrome Plated Non-Metallic Strainer	0 lb 0.0 kg	▷7301242-100.0020A	Polished Chrome	28

Optional Components:

Vandal-Resistant Stainless Steel Strainer	0 lb 0.2 kg	▷7381755-200.0020A	Polished Chrome	32
---	----------------	--------------------	-----------------	----

▷ Parts Program

ADA – Mount top of rim at 17" (432 mm) maximum from the finished floor

Meets all ANSI/ASME Low Consumption, Water Conservation Requirements.

High Efficiency Urinal (HEU) utilizes 87% less water than traditional 1.0 gpf/3.8 Lpf urinals at 0.125 gpf (0.47 Lpf).

Commercial Fixtures

High Efficiency Urinal Operates at 0.125 – 0.5 gpf (0.47 – 1.9 Lpf)



Pintbrook® 0.125 – 0.5 gpf (0.47 – 1.9 Lpf) Top Spud Urinal

- High Efficiency Urinal (HEU) operates in the range of 0.125 gpf – 0.5 gpf (0.47 Lpf – 1.9 Lpf)
- Great 1-pint flush alternate to popular Allbrook® urinal.
- Powerful washdown action
- Optimized chinaware contours provide superior splash protection
- ¾" (19 mm) inlet spud with 2" (51 mm) threaded outlet connection
- Two wall hangers included
- Fixture only
- Made in Mexico (USMCA compliant)
- Chrome plated non-metallic strainer included.

Nominal Dimensions:

14-7/16 in x 14-5/16 in x 22-5/8 in (366 mm x 363 mm x 574 mm)



Description	Net Wt	SKU	Color	List Price
Pintbrook® 0.125 – 0.5 gpf (0.47 – 1.9 Lpf) Top Spud Urinal	36 lb 16.6 kg	6002001.020	White	227

Separate Components:

K-2 Wall Hanger Bracket	0 lb 0.1 kg	▷047058-0070A	No Finish	7
Chrome Plated Non-Metallic Strainer	0 lb 0.0 kg	▷7301242-100.0020A	Polished Chrome	28

Optional Components:

Vandal-Resistant Stainless Steel Strainer	0 lb 0.2 kg	▷7381755-200.0020A	Polished Chrome	32
---	----------------	--------------------	-----------------	----

▷ Parts Program

ADA – Mount top of front rim at 17" (432 mm) maximum from the finished floor

Meets all ANSI/ASME Low Consumption, Water Conservation Requirements.

High Efficiency Urinal (HEU) utilizes 87% less water than traditional 1.0 gpf/3.8 Lpf urinals at 0.125 gpf/0.47 Lpf.

Commercial Fixtures

High Efficiency Urinals Operate in the Range of 0.125 gpf – 1.0 gpf (0.47 – 3.8 Lpf)



Washbrook® 0.125 – 1.0 gpf (0.47 – 3.8 Lpf) Top Spud Urinal With EverClean®

- High Efficiency Urinal (HEU) operates in the range of 0.125 gpf – 1.0 gpf (0.47 Lpf – 3.8 Lpf)
- EverClean® Antimicrobial Surface inhibits the growth of stain and odor causing bacteria, mold and mildew on the surface
- Flushing rim
- Elongated 14" (356 mm) rim from finished wall
- Powerful washdown action
- Extended sides for privacy
- ¾" (19 mm) inlet spud with 2" (51 mm) threaded outlet connection
- Two wall hangers included
- Fixture only
- Chrome plated non-metallic strainer included

Nominal Dimensions:

14-1/8 in x 18-7/8 in x 26-1/8 in (358 mm x 479 mm x 663 mm)



Description	Net Wt	SKU	Color	List Price
Washbrook® 0.125 – 1.0 gpf (0.47 – 3.8 Lpf) Top Spud Urinal With EverClean®	63 lb 29.0 kg	6590001EC.020	White	373

Separate Components:

K-2 Wall Hanger Bracket	0 lb 0.1 kg	▷047058-0070A	No Finish	7
Chrome Plated Non-Metallic Strainer	0 lb 0.0 kg	▷7301242-100.0020A	Polished Chrome	28

Optional Components:

Vandal-Resistant Stainless Steel Strainer	0 lb 0.2 kg	▷7381755-200.0020A	Polished Chrome	32
---	----------------	--------------------	-----------------	----



Washbrook® 0.125 – 1.0 gpf (0.47 – 3.8 Lpf) Top Spud Urinal

- High Efficiency Urinal (HEU) operates in the range of 0.125 gpf – 1.0 gpf (0.47 Lpf – 3.8 Lpf)
- Flushing rim
- Elongated 14" (356 mm) rim from finished wall
- Powerful washdown action
- Extended sides for privacy
- ¾" (19 mm) inlet spud with 2" (51 mm) threaded outlet connection
- Two wall hangers included
- Fixture only
- Chrome plated non-metallic strainer included

Nominal Dimensions:

14-1/8 in x 18-7/8 in x 26-1/8 in (358 mm x 479 mm x 663 mm)



Description	Net Wt	SKU	Color	List Price
Washbrook® 0.125 – 1.0 gpf (0.47 – 3.8 Lpf) Top Spud Urinal	63 lb 29.0 kg	6590001.020	White	309

Separate Components:

K-2 Wall Hanger Bracket	0 lb 0.1 kg	▷047058-0070A	No Finish	7
Chrome Plated Non-Metallic Strainer	0 lb 0.0 kg	▷7301242-100.0020A	Polished Chrome	28

Optional Components:

Vandal-Resistant Stainless Steel Strainer	0 lb 0.2 kg	▷7381755-200.0020A	Polished Chrome	32
---	----------------	--------------------	-----------------	----

▷ Parts Program

ADA – Mount top of front rim at 17" (432 mm) maximum from the finished floor

Meets all ANSI/ASME Low Consumption, Water Conservation Requirements.

High Efficiency Urinal (HEU) utilizes 50% less water than traditional 1.0 gpf/3.8 Lpf urinals at 0.5 gpf/1.9 Lpf and 87% less water at 0.125 gpf/0.47 Lpf.

Commercial Fixtures

High Efficiency Urinals Operate in the Range of 0.125 gpf – 1.0 gpf (0.47 – 3.8 Lpf)



Washbrook 0.125 -1.0 gpf (0.47 - 3.8 Lpf) Back Spud Urinal

- High Efficiency Urinal (HEU) operates in the range of 0.125 gpf – 1.0 gpf (0.47 Lpf – 3.8 Lpf)
- Flushing rim
- Elongated 14" (356 mm) rim from finished wall
- Powerful washdown action
- Extended sides for privacy
- ¾" (19 mm) inlet spud with 2" (51 mm) threaded outlet connection
- Two wall hangers included
- Fixture only
- Chrome plated non-metallic strainer included.

Nominal Dimensions:

14-1/8 in x 18-7/8 in x 26-1/8 in (358 mm x 479 mm x 663 mm)



Description	Net Wt	SKU	Color	List Price
Washbrook 0.125 -1.0 gpf (0.47 - 3.8 Lpf) Back Spud Urinal	63 lb 29.0 kg	6515001.020	White	360

Separate Components:

K-2 Wall Hanger Bracket	0 lb 0.1 kg	▷047058-0070A	No Finish	7
Chrome Plated Non-Metallic Strainer	0 lb 0.0 kg	▷7301242-100.0020A	Polished Chrome	28

Optional Components:

Vandal-Resistant Stainless Steel Strainer	0 lb 0.2 kg	▷7381755-200.0020A	Polished Chrome	32
---	----------------	--------------------	-----------------	----

▷ Parts Program

ADA – Mount top of front rim at 17" (432 mm) maximum from the finished floor

Meets all ANSI/ASME Low Consumption, Water Conservation Requirements.

High Efficiency Urinal (HEU) utilizes 50% less water than traditional 1.0 gpf/3.8 Lpf urinals at 0.5 gpf (1.9 Lpf) and 87% less water at 0.125 gpf (0.47 Lpf).

Commercial Fixtures

High Efficiency Urinals Operate in the Range of 0.125 – 1.0 gpf (0.47 – 3.8 Lpf)



Maybrook® 0.125 – 1.0 gpf (0.47 – 3.8 Lpf) Top Spud Urinal With EverClean®

- High Efficiency Urinal (HEU) operates in the range of 0.125 gpf – 1.0 gpf (0.47 Lpf – 3.8 Lpf)
- EverClean® Antimicrobial Surface inhibits the growth of stain and odor causing bacteria, mold and mildew on the surface
- Flushing rim
- Powerful washdown action
- Integral strainer
- ¾" (19 mm) inlet spud
- Outlet spud with 1-½" (38 mm) tubing tailpiece
- Wall hanger included
- Fixture only

Nominal Dimensions:

12-3/4 in x 12-3/4 in x 18 in (323 mm x 323 mm x 457 mm)



Description	Net Wt	SKU	Color	List Price
Maybrook® 0.125 – 1.0 gpf (0.47 – 3.8 Lpf) Top Spud Urinal With EverClean®	32 lb 14.5 kg	6581001EC.020	White	249

Separate Components:

K-2 Wall Hanger Bracket	0 lb 0.1 kg	▷047058-0070A	No Finish	7
-------------------------	----------------	---------------	-----------	---



Maybrook® 0.125 – 1.0 gpf (0.47 – 3.8 Lpf) Top Spud Urinal

- High Efficiency Urinal (HEU) operates in the range of 0.125 gpf – 1.0 gpf (0.47 Lpf – 3.8 Lpf)
- Flushing rim
- Powerful washdown action
- Integral strainer
- ¾" (19 mm) inlet spud
- Outlet spud with 1-½" (38 mm) tubing tailpiece
- Wall hanger included
- Fixture only

Nominal Dimensions:

12-3/4 in x 12-3/4 in x 18 in (323 mm x 323 mm x 457 mm)



Description	Net Wt	SKU	Color	List Price
Maybrook® 0.125 – 1.0 gpf (0.47 – 3.8 Lpf) Top Spud Urinal	32 lb 14.5 kg	6581001.020	White	235

Separate Components:

K-2 Wall Hanger Bracket	0 lb 0.1 kg	▷047058-0070A	No Finish	7
-------------------------	----------------	---------------	-----------	---

▷ Parts Program

Meets all ANSI/ASME Low Consumption, Water Conservation Requirements.

High Efficiency Urinal (HEU) utilizes 50% less water than traditional 1.0 gpf/3.8 Lpf urinals at 0.5 gpf/1.9 Lpf and 87% less water at 0.125 gpf/0.47 Lpf.

Commercial Fixtures

High Efficiency Urinals Operate in the Range of 0.5 – 1.0 gpf (1.9 – 3.8 Lpf)



Allbrook® 0.5 – 1.0 gpf (1.9 – 3.8 Lpf) Top Spud Siphon Jet Urinal

- Operates in the range of 0.5 gpf – 1.0 gpf (1.9 Lpf – 3.8 Lpf)
- Flushing rim
- Siphon jet flush action
- ¾" (19 mm) inlet spud with 2" (51 mm) threaded outlet connection
- Wall hanger included
- Fixture only

Nominal Dimensions:

14-5/16 in x 14-5/16 in x 21-1/2 in (363 mm x 363 mm x 546 mm)



Description	Net Wt	SKU	Color	List Price
Allbrook® 0.5 – 1.0 gpf (1.9 – 3.8 Lpf) Top Spud Siphon Jet Urinal	28 lb 12.9 kg	6550001.020	White	205

Separate Components:

K-2 Wall Hanger Bracket	0 lb 0.1 kg	▷047058-0070A	No Finish	7
-------------------------	----------------	---------------	-----------	---

▷ Parts Program

ADA – Mount top of front rim at 17" (432 mm) maximum from the finished floor

Meets all ANSI/ASME Low Consumption, Water Conservation Requirements.

High Efficiency Urinal (HEU) utilizes 50% less water than traditional 1.0 gpf/3.8 Lpf urinals at 0.5 gpf/1.9 Lpf.

Commercial Fixtures

Low Consumption Urinals 1.0 gpf/3.8 Lpf or Less



Stallbrook® 0.5 – 1.0 gpf (1.9 – 3.8 Lpf) Top Spud Urinal

- Operates in the range of 0.5 gpf – 1.0 gpf (1.9 Lpf – 3.8 Lpf)
- Sloping front stall urinal
- Integral flush spreader
- Powerful washdown action
- ¾" (19 mm) inlet spud
- Fixture only

Nominal Dimensions:

15 in x 18 in x 38-1/4 in (381 mm x 457 mm x 971 mm)



Description	Net Wt	SKU	Color	List Price
Stallbrook® 0.5 – 1.0 gpf (1.9 – 3.8 Lpf) Top Spud Urinal	112 lb 50.8 kg	6400001.020	White	758

ADA – Electronic flush valve required to meet ADA flushometer valve height requirement.



Lynbrook® 1.0 gpf/3.8 Lpf Top Spud Blowout Urinal ✧

- Low consumption (1.0 gpf/3.8 Lpf)
- Flushing rim
- Blowout flush action
- Privacy shields
- 1-¼" (32 mm) inlet spud
- 2" (51 mm) threaded outlet connection
- Two wall hangers included
- Fixture only

Nominal Dimensions:

14 in x 18-1/2 in x 28-3/4 in (355 mm x 469 mm x 730 mm)



Description	Net Wt	SKU	Color	List Price
Lynbrook® 1.0 gpf/3.8 Lpf Top Spud Blowout Urinal	59 lb 27.0 kg	6601012.020	White	459

ADA – Mount top of front rim at 17" (432 mm) maximum from the finished floor



Trimbrook® 1.0 gpf/3.8 Lpf Top Spud Siphon Jet Urinal ✧

- Low consumption (1.0 gpf/3.8 Lpf)
- Flushing rim
- Siphon jet flush action
- Extended sides for privacy
- ¾" (19 mm) inlet spud with 2" (51 mm) threaded outlet connection
- Two wall hangers included
- Fixture only

Nominal Dimensions:

14 in x 17-1/2 in x 26-3/4 in (355 mm x 444 mm x 679 mm)



Description	Net Wt	SKU	Color	List Price
Trimbrook® 1.0 gpf/3.8 Lpf Top Spud Siphon Jet Urinal	71 lb 32.2 kg	6561017.020	White	415



ADA – Mount top of front rim at 17" (432 mm) maximum from the finished floor

Meets all ANSI/ASME Low Consumption, Water Conservation Requirements.

✧ Check local codes to determine if urinals above 0.5 gpf are allowed in your area.

Commercial Fixtures

Commercial Parts

Description	SKU #	Color/Finish	List Price
S-9 Lavatory Wall Hanger <ul style="list-style-type: none"> • For use with Decorum™ 9134 and 9024 series wall hung sinks • Galvanized steel construction 	382430-1120A	No Finish	12
K-2 Wall Hanger Bracket <ul style="list-style-type: none"> • For use with Decorum®, Pintbrook®, Washbrook®, Maybrook® and Allbrook® urinals • Metal construction 	047058-0070A	No Finish	7 
T-7-F Lavatory Wall Hanger <ul style="list-style-type: none"> • For use with 9062 country sink • Cast iron 	382430-115.0070A	No Finish	67
1-1/2-Inch Toilet Spud <ul style="list-style-type: none"> • 1-1/2" x 1-1/2" inlet spud 	047007-0070A	No Finish	25 
Urinal Inlet Spud <ul style="list-style-type: none"> • 1" x 3/4" inlet spud 	047003-0070A	No Finish	19 
Urinal Inlet Spud <ul style="list-style-type: none"> • 1-1/4" x 1-1/4" inlet spud 	047005-0070A	No Finish	25

Warranties

American Standard product warranty information is available online by visiting:
americanstandard.com/warranty or scan the **QR code** below.



1-Pint Flush Urinals

Highest efficiency 0.125 gpf urinals available for all commercial needs.



Greenbrook®



Washbrook®



Decorum®



Pintbrook®



Maybrook®

SKU		URINAL DESCRIPTION	NOMINAL DIMENSIONS	URINAL FLUSH RATING
6516002EC	ADA	Greenbrook with EverClean®, Top Spud	15-1/8" x 16-5/8" x 27-1/2"	0.125 to 0.50 gpf (0.47 to 1.9 Lpf)
6517001EC	ADA	Greenbrook with EverClean, Back Spud		
6590001EC	ADA	Washbrook with EverClean, Top Spud	14-1/8" x 18-7/8" x 26-1/8"	0.125 to 1.0 gpf (0.47 to 3.8 Lpf)
6590001	ADA	Washbrook, Top Spud		
6515001	ADA	Washbrook, Back Spud		
6042001EC	ADA	Decorum with EverClean, Top Spud	14" x 13-5/16" x 21-1/2"	0.125 gpf (0.47 Lpf)
6043001EC	ADA	Decorum with EverClean, Back Spud		
6002001	ADA	Pintbrook, Top Spud	14-7/16" x 14-5/16" x 22-5/8"	0.125 to 0.50 gpf (0.47 to 1.9 Lpf)
6581001EC		Maybrook with EverClean, Top Spud	12-3/4" x 12-3/4" x 18"	0.125 to 1.0 gpf (0.47 to 3.8 Lpf)
6581001		Maybrook, Top Spud		

EverClean Surface

- EverClean is an antimicrobial additive that inhibits the growth of stain and odor causing bacteria, mold and mildew on the surface
- Double coat glaze process
- Continuously repels dirt and grime — smoother surface reduces ability to adhere



Meets all ANSI/ASME Low Consumption, Water Conservation Requirements.

High Efficiency Urinal (HEU) utilizes 50% less water than traditional 1.0 gpf/3.8 Lpf urinals at 0.5 gpf (1.9 Lpf) and 87% less water at 0.125 gpf (0.47 Lpf).

Find Our Products Here

REVIT, Specs, CAD and BIM Availability

Through our partner ATS, American Standard Brands provides a complete plumbing specification solution for your Revit and 3D projects. With over 8,500 product combinations accessible for immediate download and new files being added daily, ATS is the largest source for Revit plumbing equipment. ATS and American Standard's combined 3D BIM families can be easily accessed and downloaded at no-cost to the specification design community. For more information, please visit our partner website, www.atsspec.net.

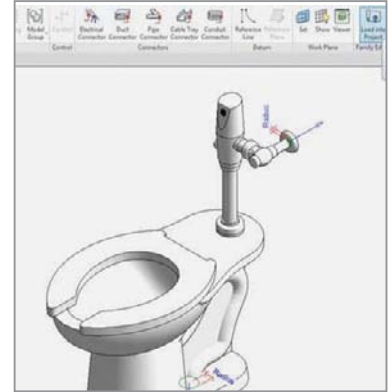

Revit Families Available



SpecLink

MasterSpec®



Related Literature



2023 Residential Fixtures and Fittings List Price Guide



2023 Distributor Support Programs Brochure



2023 LIXIL Builder Advantage Program Brochure

For American Standard Customer Care

Call 1-800-442-1902 – Monday – Friday, 8:00 am – 7:00 pm EST

Visit www.americanstandard.com

Front Cover: Aftwall® Millennium® bowl with EverClean® (3351101.020), Ultima® Selectronic® diaphragm toilet flush valve (6247121.002), Decorum® wall-hung sink with EverClean® (9134001EC.020), optional sink shroud (0059020EC.020), and Paradigm® Selectronic® integrated faucet with above deck mixing (7025205.002)