

Residential Fixtures and Faucets

List Price Guide – April 1, 2023



American Standard

Fixture Colors and Finishes

The color availability of each product is shown beneath the product categories in this chart. This guide also provides the color codes assigned to each color or finish.

Kitchen Sinks			
			
White 020	Stainless Steel 075 [†]	Brilliant White 308	
Ceramic – Bathroom Sinks and Toilets			
			
White 020	Linen 222	Bone 021	
Baths and Whirlpools			
			
Arctic 011 [*]	White 020	Linen 222	
Acrylic and Gelcoat Walk-in Baths		Shower Bases	
			
White W	Linen L	White 020	Soft White 218
Shower Glass Doors			
			
Clear 400	Rain 422	Hammered 436	
Americast [®] and Enameled Tubs			
			
Arctic 011	White 020	Linen 222	Bone 021
Furniture			
			
White 020	Smoked Grey 475	Dark Cherry 476	Quartz 820
			
Dark Grey 477	Ash 478	Walnut 479	

Color	Color Code
Trim & Accessory Finishes [§]	
Polished Chrome	002
Arctic	011
Polished Nickel	013
White	020
Bone	021
Brushed Stainless Steel	073
Polished Brass	099
Matte Black	243
Legacy Bronze	278
Brushed Nickel	295
Shower Door Finishes [‡]	
Brushed Nickel	006
Silver	213
Oil Rubbed Bronze	224

* For bathtubs & whirlpools only

† For kitchen sinks only

‡ Not pictured

§ Available for select products only

|| See shower door description for specific glass availability in that style.

Color samples may vary slightly from the actual colors. Not all colors and finishes are available on all products.

American Standard

LIFE.LOVE.HOME

Icons

Kitchen Sinks

- Inspired Possibilities
- Kitchen Sinks Overview
- Country Kitchen Sink
- Cast Iron Sinks
- Stainless Steel Sinks
- Sink/Faucet Systems

Kitchen Faucets

- Selectronic® Hands-Free Technology
- SelectFlo® Multi-Function Spray Technology
- Kitchen and Bar Faucets Overview
- Pull-Down Faucets
- Pull-Out Faucets
- Touchless Faucets
- Beale® MeasureFill™ Faucet
- Single-Handle Faucets
- 2-Handle Faucets
- Single-Handle Bar Faucets
- 2-Handle Bar Faucets
- Semi-Professional Faucets
- Pot Filler
- Laundry Faucet
- Accessories

Bathing

- Safer and Accessible Living
- Independent, Safer and Comfortable Bathing
- Acrylic Walk-In Baths
- Gelcoat Walk-In Baths
- Walk-In Bath Accessories
- Seated Shower
- Safety Tubs
- Freestanding Bathtubs
- Freestanding Bathtubs Overview
- Drains and Accessories
- Bathtubs Overview
- Bathtub Systems
- EverClean® System
- Whirlpools and Air Baths
- Bathtubs – Soakers
- Bathtubs – Whirlpools
- Bathtubs – Air Baths
- Bathtubs – Combination Spas
- Americast® Enameled Steel
- Enameled Steel Bathtubs

Continued on next page.

Shower and Tub Doors

Shower and Tub Doors Overview	
How to Measure the Perfect Shower Door	
Frameless Shower Doors	
Semi-Frameless Shower Doors	
Framed Shower Doors	
Shower and Tub Enclosure/Bathing Fixture Cross Reference	

Shower Bases

Acrylic Shower Bases	
Solid Surface Shower Bases	

Bathroom Furniture

Furniture Overview	
Consoles	
Washstands	
Vanities	
American Standard® Furniture for Townsend®	

Bathroom Sinks

Bathroom Sinks Overview	
Pedestal Sinks	
Above Counter Sinks	
Drop-In Sinks	
Under Counter Sinks	
Wall-Hung Sinks	

Toilets







No-Touch Flush for Home and Business	
Studio® S Low Profile One-Piece Toilet	
Standard Toilets Overview	
One-Piece Toilets	
Two-Piece Toilets	
Bidets	
Advanced Clean® SpaLet® Bidet Toilet	
SpaLet Bidet Seats	
Toilet Seats	
Toilet Trip Levers	
Optional Toilet Tanks	

Residential Faucets

Warranties

Icons

Look for these symbols throughout our **List Price Guide** to quickly identify key information and important features of our products. Each symbol is prominently displayed to make your purchasing decision easier and ensure your choice of product meets your requirements.

 NEW	New product or feature introduced for 2023.
 PREMIER	Premier product by American Standard.
 SHOWROOM ENJOY (MORE) REWARDS	Product eligible to earn points in showroom sales based Enjoy (more) Rewards program. Please check the website for the most updated eligible products www.mylixilemr.com
 MAP	All products displaying this symbol are protected by American Standard's Unilateral Suggested Minimum Advertised Price Program (USMAP). All UMAP protected products contained within this publication are subject to change. For additional information see UMAP Policy section with the Distributor Support Programs.
 ADA COMPLIANT	Meets the Americans with Disabilities Act guidelines and ANSI A117.1 requirements for accessible and usable building facilities – check local codes.
 CALIFORNIA ENERGY COMMISSION	Meets California Energy Commission requirements.
 EPA WATERSENSE CERTIFIED	WaterSense® Certified. Tested and certified to comply the applicable EPA WaterSense specification.

✦ Check your local codes to determine if 1.6 gpf/6.0 Lpf toilets are allowed in your area.

CALGreen® is a registered trademark of California Building Standards Commission.

Images throughout the price guide are for illustrative purpose only – actual features may vary.

Kitchen Sinks

From the sleek luster of stainless steel to the charm of a farmhouse style, every kitchen sink in the American Standard collection is crafted for superior performance and lasting durability. Meticulously designed for the busiest kitchens, when only the best will do.



Kitchen Sinks

Inspired Possibilities

The kitchen has changed dramatically over the years. It has become automated, wired and built to ease the stress of today's family on the go. But, just as it was 100 years ago, and will likely be 100 years from now, the kitchen remains the heart of the home; for that reason, our sinks and accessories are designed with you and your everyday life in mind.

The kitchen sink is likely one of the most used appliances in your home.

Whether it's washing dishes, prepping food or just cleaning your hands – through it all, you expect your sink to last and look good while doing so. American Standard is dedicated to providing kitchen sinks and accessories that work hard for you while still boasting the quality and timeless style that you deserve.

Why Choose American Standard Sinks?

Our sinks are made with you in mind, with multiple materials and designs to choose from and several installation options for both replacement and custom solutions.

Performance

Our use of long-lasting, solid materials and our flawless attention to detail creates dependable performance for life.



Durable – Stainless steel comes in many different shapes, sizes and thicknesses. American Standard offers 16, 18 and 20-gauge T304 stainless steel.

Eco-Friendly – All of our sinks are lead-free, and our Fine Fireclay models are crafted from recyclable, eco-friendly materials.

Sustainable – Our cast iron sinks are crafted from over 80% recycled or reclaimed iron, making them a great choice for the environmentally conscious home owner.



Pekoe® 33" Stainless Steel Apron Sink
18SB.9332200A.075

Technology

Our innovations make life easier and more enjoyable by solving the little and not so little problems of everyday living.



Quiet
SoundSecure™ – Rubber sound pads on the bottom of the sink help to reduce excess sound and vibration during use.



SoundSecure+™ – Exceptional sound deadening with rubber sound pads on both the bottom and sides of the underside of the sink.



Protected
StoneLock™ – Our multilayer spray insulation covers the underside of your sink to further help with sound absorption and to minimize condensation.



Delancey® 39" Cast Iron Sink
77DB30190.308

Kitchen Sinks

Kitchen Sinks Overview

Country Kitchen Sink

			
---	--	--	--

Delancey® Cast Iron

Quince® Cast Iron

			
--	--	---	--

Kitchen Sinks

Kitchen Sinks Overview

Pekoe® Stainless Steel



Edgewater® Stainless Steel

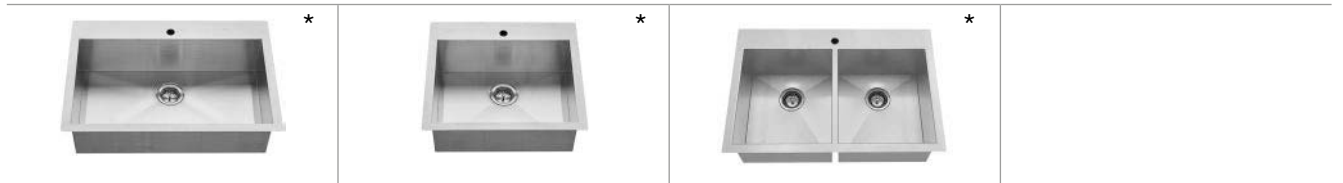

Portsmouth® Stainless Steel



Reliant® Stainless Steel



Colony® Kitchen Sinks and Faucet Systems



Hillsdale Stainless Steel

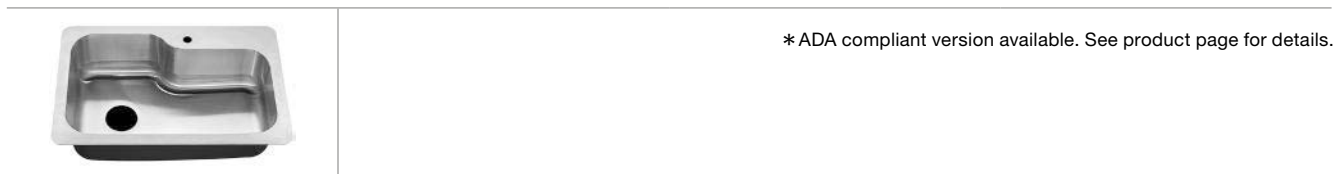



30 x 22-Inch Vitreous China 2-Hole Single Bowl Country Kitchen Sink

- High splash back
- Vitreous china
- Faucet holes on 8" (203 mm) centers for wall-mounted sink faucet
- 3-1/2" (89 mm) drain with strainer included
- Requires support framing in cabinetry

Nominal Dimensions:

22 in x 30 in x 9-1/2 in (558 mm x 762 mm x 241 mm)

Bowl Size:

18 in (wide) 26-1/2 in (front to back) 8 in (deep)



Description	Net Wt	SKU	Color	List Price
30 x 22-Inch Vitreous China 2-Hole Single-Bowl Country Kitchen Sink	100 lb 45.4 kg	9062008.020	White	1,168



Delancey® 36 x 22-Inch Cast Iron 4-Hole Undermount Single Bowl Apron Front Kitchen Sink

- Cast Iron Single Bowl Apron Front Sink
- 8-7/8" (225 mm) depth
- Undermount installation
- 4 oversized holes
- Lustrous Brilliant White finish
- 39" minimum cabinet base required
- Limited Lifetime Warranty

Nominal Dimensions:

22-1/16 in x 36 in x 8-13/16 in (560 mm x 914 mm x 223 mm)

Bowl Size:

32-9/16 in (wide) 15-3/8 in (front to back) 8-5/8 in (deep)



Description	Net Wt	SKU	Color	List Price
Delancey® 36 x 22-Inch Cast Iron 4-Hole Undermount Single-Bowl Apron Front Kitchen Sink	165 lb 75.3 kg	77SB36220A.308	Brilliant White	1,549

Optional Components:

Delancey® 36-Inch Single Bowl Apron Front Kitchen Sink Grid	3 lb 1.4 kg	8430000.075	Stainless Steel	210
Waste Fitting	0 lb 0.3 kg	9028000.075	Stainless Steel	33



Delancey® 33 x 22-Inch Cast Iron 4-Hole Undermount Single Bowl Apron Front Kitchen Sink

- Cast Iron Single Bowl Apron Front Sink
- 8-7/8" (225 mm) depth
- Undermount installation
- 4 oversized holes
- Lustrous Brilliant White finish
- 36" minimum cabinet base required
- Limited Lifetime Warranty

Nominal Dimensions:

22-3/16 in x 33-1/16 in x 8-13/16 in (563 mm x 839 mm x 223 mm)

Bowl Size:

29-1/8 in (wide) 15 in (front to back) 8-3/4 in (deep)



Description	Net Wt	SKU	Color	List Price
Delancey® 33 x 22-Inch Cast Iron 4-Hole Undermount Single-Bowl Apron Front Kitchen Sink	176 lb 79.9 kg	77SB33220A.308	Brilliant White	1,493

Optional Components:

Delancey® 33-Inch Single Bowl Apron Front Kitchen Sink Grid	2 lb 1.1 kg	8418000.075	Stainless Steel	183
Waste Fitting	0 lb 0.3 kg	9028000.075	Stainless Steel	33



Delancey® 30 x 22-Inch Cast Iron 4-Hole Undermount Single Bowl Apron Front Kitchen Sink

- Single bowl sink
- 8-7/8" (25 mm) depth
- Undermount installation
- 4 oversized holes
- Lustrous Brilliant White finish
- 33" minimum cabinet base required
- Cast Iron Single Bowl Apron Front Sink
- Brilliant White Finish
- Undermount Installation
- Limited Lifetime Warranty

Nominal Dimensions:

22-1/16 in x 30 in x 8-13/16 in (560 mm x 762 mm x 223 mm)

Bowl Size:

26-1/16 in (wide) 15-3/8 in (front to back) 8-5/8 in (deep)



Description	Net Wt	SKU	Color	List Price
Delancey® 30 x 22-Inch Cast Iron 4-Hole Undermount Single-Bowl Apron Front Kitchen Sink	139 lb 63.1 kg	77SB30220A.308	Brilliant White	1,442

Optional Components:

Delancey® 30-Inch Single Bowl Kitchen Sink Grid	2 lb 1.1 kg	8432000.075	Stainless Steel	171
Waste Fitting	0 lb 0.3 kg	9028000.075	Stainless Steel	33



Delancey® 36 x 22-Inch Cast Iron 4-Hole Undermount Double Bowl Apron Front Kitchen Sink

- Cast Iron Double Bowl Apron Front Sink
- 8-7/8" (225 mm) depth
- Under mount installation
- 4 oversized holes
- Lustrous Brilliant white finish
- 39" (991 mm) minimum cabinet base required
- Limited Lifetime Warranty

Nominal Dimensions:

22-1/16 in x 36 in x 8-13/16 in (560 mm x 914 mm x 223 mm)

Bowl Size:

32-9/16 in (wide) 15-3/8 in (front to back) 8-5/8 in (deep)



Description	Net Wt	SKU	Color	List Price
Delancey® 36 x 22-Inch Cast Iron 4-Hole Undermount Double-Bowl Apron Front Kitchen Sink	182 lb 82.9 kg	77DB36220A.308	Brilliant White	1,725

Optional Components:

Delancey® 36-Inch Double Bowl Apron Front Kitchen Sink Grid – Pack of 2	2 lb 1.4 kg	8431000.075	Stainless Steel	235
Waste Fitting	0 lb 0.3 kg	9028000.075	Stainless Steel	33



Delancey® 33 x 22-Inch Cast Iron 4-Hole Undermount Double Bowl Apron Front Kitchen Sink

- Cast Iron Double Bowl Apron Front Sink
- 8-7/8" (225 mm) depth
- Undermount installation
- 4 oversized holes
- Lustrous Brilliant white finish
- 36" (914 mm) minimum cabinet base required
- Limited Lifetime Warranty

Nominal Dimensions:

22-1/16 in x 33-1/16 in x 8-13/16 in (560 mm x 839 mm x 223 mm)

Bowl Size:

13-7/16 in (wide) 15-1/16 in (front to back) 8-11/16 in (deep)



Description	Net Wt	SKU	Color	List Price
Delancey® 33 x 22-Inch Cast Iron 4-Hole Undermount Double-Bowl Apron Front Kitchen Sink	176 lb 79.9 kg	77DB33220A.308	Brilliant White	1,656

Optional Components:

Delancey® 33 x 22-Inch Double Bowl Apron Front Kitchen Sink Grid – Pack of 2	2 lb 1.1 kg	8419000.075	Stainless Steel	210
Waste Fitting	0 lb 0.3 kg	9028000.075	Stainless Steel	33



Delancey® 30 x 19-Inch Cast Iron Undermount Single Bowl Kitchen Sink

- Single bowl sink
- Undermount installation
- Lustrous Brilliant White finish
- 33" (838 mm) minimum cabinet base required
- Limited Lifetime Warranty

Nominal Dimensions:

19 in x 30 in x 8-3/4 in (482 mm x 762 mm x 222 mm)

Bowl Size:

26-1/16 in (wide) 15-3/8 in (front to back) 8-11/16 in (deep)



Description	Net Wt	SKU	Color	List Price
Delancey® 30 x 19-Inch Cast Iron Undermount Single-Bowl Kitchen Sink	97 lb 44.2 kg	77SB30190.308	Brilliant White	998

Optional Components:

Delancey® 30-Inch Single Bowl Kitchen Sink Grid	2 lb 1.1 kg	8432000.075	Stainless Steel	171
Waste Fitting	0 lb 0.3 kg	9028000.075	Stainless Steel	33



Delancey® 18 x 16-Inch Cast Iron Undermount Single Bowl Kitchen Sink

- Single bowl sink
- Undermount installation
- Lustrous Brilliant White finish
- 21" (533 mm) minimum cabinet base required
- 8" deep bowl
- Undermount Installation
- Minimum 21" (533mm) cabinet required
- Limited Lifetime Warranty

Nominal Dimensions:

16 in x 18 in x 8 in (406 mm x 457 mm x 203 mm)

Bowl Size:

14-13/16 in (wide) 12-13/16 in (front to back) 8 in (deep)



Description	Net Wt	SKU	Color	List Price
Delancey® 18 x 16-Inch Cast Iron Undermount Single-Bowl Kitchen Sink	51 lb 23.4 kg	77SB16180.308	Brilliant White	638

Optional Components:

Delancey® 16 x 18-Inch Single Bowl Cast Iron Kitchen Sink Grid	1 lb 0.5 kg	8422000.075	Stainless Steel	132
Waste Fitting	0 lb 0.3 kg	9028000.075	Stainless Steel	33



Delancey® 30 x 19-Inch Cast Iron Undermount Double Bowl Kitchen Sink

- Cast Iron Double Bowl Sink
- Under mount installation
- Lustrous Brilliant White finish
- 33" (838 mm) minimum cabinet base required
- 8-7/8" deep bowls
- Limited Lifetime Warranty

Nominal Dimensions:

19-1/16 in x 30-1/16 in x 8.85 in (484 mm x 763 mm x 224 mm)

Bowl Size:

11-11/16 in (wide) 15-3/8 in (front to back) 8-11/16 in (deep)



Description	Net Wt	SKU	Color	List Price
Delancey® 30 x 19-Inch Cast Iron Undermount Double-Bowl Kitchen Sink	90 lb 41.0 kg	77DB30190.308	Brilliant White	1,008

Optional Components:

Delancey® 30 x 19-Inch Double Bowl Kitchen Sink Grid – Pack of 2	2 lb 1.0 kg	8433000.075	Stainless Steel	210
Waste Fitting	0 lb 0.3 kg	9028000.075	Stainless Steel	33



Quince® 33 x 22-Inch Cast Iron 3-Hole Drop-In Single Bowl Kitchen Sink

- Cast Iron Single Bowl Sink
- Convenient drop-in installation
- Lustrous Brilliant White finish
- 3-hole
- Offset drain
- 36" (914 mm) minimum cabinet base required
- 9-3/8" deep bowl
- Limited Lifetime Warranty

Nominal Dimensions:

22-1/16 in x 33 in x 9-15/16 in (560 mm x 838 mm x 252 mm)

Bowl Size:

30-1/4 in (wide) 19-5/16 in (front to back) 9-3/8 in (deep)



Description	Net Wt	SKU	Color	List Price
Quince® 33 x 22-Inch Cast Iron 3-Hole Drop-In Single-Bowl Kitchen Sink	105 lb 47.7 kg	77SB33223.308	Brilliant White	769

Optional Components:

Quince® 33 x 22-Inch Single Bowl Kitchen Sink Grid	3 lb 1.4 kg	8415000.075	Stainless Steel	171
Waste Fitting	0 lb 0.3 kg	9028000.075	Stainless Steel	33



Quince® 25 x 22-Inch Cast Iron 3-Hole Drop-In Single Bowl Kitchen Sink

- Single bowl sink
- Convenient drop-in installation
- Lustrous Brilliant White finish
- 3-hole drop-in sink
- 27" (686 mm) minimum cabinet base required
- Cast Iron Single Bowl Sink
- 3 hole
- 9" deep bowl
- Limited Lifetime Warranty

Nominal Dimensions:

21-15/16 in x 25 in x 8-7/8 in (557 mm x 635 mm x 225 mm)

Bowl Size:

21-7/16 in (wide) 15-3/4 in (front to back) 8-7/8 in (deep)



Description	Net Wt	SKU	Color	List Price
Quince® 25 x 22-Inch Cast Iron 3-Hole Drop-In Single-Bowl Kitchen Sink	73 lb 33.2 kg	77SB25223.308	Brilliant White	668

Optional Components:

Quince® 25 x 22-Inch Single Bowl Kitchen Sink Grid	1 lb 0.8 kg	8414000.075	Stainless Steel	157
Waste Fitting	0 lb 0.3 kg	9028000.075	Stainless Steel	33



Quince® 25 x 22-Inch Cast Iron 4-Hole Drop In Single Bowl Kitchen Sink

- Single bowl sink
- Convenient drop-in installation
- Lustrous brilliant white finish
- 4-hole drop-in sink
- 27" (686 mm) minimum cabinet base required
- Cast iron single bowl sink
- 4 hole
- 9" deep bowl
- Limited Lifetime Warranty

Nominal Dimensions:

25 in x 21-15/16 in x 8-7/8 in (635 mm x 557 mm x 225 mm)

Bowl Size:

21-7/16 in (wide) 15-3/4 in (front to back)



Description	Net Wt	SKU	Color	List Price
Quince® 25 x 22-Inch Cast Iron 4-Hole Drop-In Single-Bowl Kitchen Sink	73 lb 33.2 kg	77SB25224.308	Brilliant White	668

Optional Components:

Quince® 25 x 22-Inch Single Bowl Kitchen Sink Grid	1 lb 0.8 kg	8414000.075	Stainless Steel	157
Waste Fitting	0 lb 0.3 kg	9028000.075	Stainless Steel	33



Quince® 33 x 22-Inch Cast Iron 3-Hole Drop In or Undercounter Double Bowl Kitchen Sink

- Cast Iron Double Bowl Sink
- Convenient drop-in or undercounter installation
- Lustrous Brilliant White finish
- 3-hole drop-in or undercounter
- Offset drain
- 36" (914 mm) minimum cabinet base required
- 9" deep bowls
- Limited Lifetime Warranty

Nominal Dimensions:

22-1/4 in x 32-15/16 in x 9 in (565 mm x 836 mm x 228 mm)

Bowl Size:

13-1/2 in (wide) 16-1/8 in (front to back) 9 in (deep)



Description	Net Wt	SKU	Color	List Price
Quince® 33 x 22-Inch Cast Iron 3-Hole Drop-In or Undercounter Double-Bowl Kitchen Sink	108 lb 49.2 kg	77DB33223.308	Brilliant White	897

Optional Components:

Quince® 33 x 22-Inch Double Bowl Kitchen Sink Grid – Set of 2	2 lb 1.2 kg	8416000.075	Stainless Steel	210
Waste Fitting	0 lb 0.3 kg	9028000.075	Stainless Steel	33



Quince® 33 x 22-Inch Cast Iron 4-Hole Drop In or Undercounter Double Bowl Kitchen Sink

- Cast iron double bowl sink
- Convenient drop-in or undercounter installation
- Lustrous brilliant white finish
- 4-hole drop-in or undercounter sink
- Offset drain
- 36" (914 mm) minimum cabinet base required
- 9" deep bowls
- Limited Lifetime Warranty

Nominal Dimensions:

32-15/16 in x 22-1/4 in x 9 in (836 mm x 565 mm x 228 mm)

Bowl Size:

13-1/2 in (wide) 16-1/8 in (front to back)



Description	Net Wt	SKU	Color	List Price
Quince® 33 x 22-Inch Cast Iron 4-Hole Drop-In or Undercounter Double-Bowl Kitchen Sink	108 lb 49.2 kg	77DB33224.308	Brilliant White	897

Optional Components:

Quince® 33 x 22-Inch Double Bowl Kitchen Sink Grid – Set of 2	2 lb 1.2 kg	8416000.075	Stainless Steel	210
Waste Fitting	0 lb 0.3 kg	9028000.075	Stainless Steel	33



Pekoe® 33 x 22-Inch Stainless Steel Single Bowl Farmhouse Apron Front Kitchen Sink

- 18 gauge stainless steel
- Fabricated single bowl apron sink
- 10 mm radius corners
- 9" (229 mm) deep bowl
- Undermount or flush mount installation
- SoundSecure™ sound pads
- StoneLock™ undercoating
- Bottom grid included
- Waste fitting included
- Limited Lifetime Warranty

Nominal Dimensions:

22 in x 33 in x 9 in (558 mm x 838 mm x 228 mm)

Bowl Size:

30-1/4 in (wide) 16-1/2 in (front to back) 9 in (deep)



Description	Net Wt	SKU	Color	List Price
Pekoe® 33 x 22-Inch Stainless Steel Single-Bowl Farmhouse Apron Front Kitchen Sink	35 lb 16.2 kg	18SB.9332200A.075	Stainless Steel	981

Separate Components:

16 x 29-Inch Stainless Steel Kitchen Sink Grid	2 lb 1.0 kg	7434000.075	Stainless Steel	199
Waste Fitting	0 lb 0.3 kg	9028000.075	Stainless Steel	33



Pekoe® 30 x 22-Inch Stainless Steel Single Bowl Farmhouse Kitchen Sink

- 18 gauge stainless steel
- Fabricated single bowl apron sink
- 10 mm radius corners
- 9" (229 mm) deep bowl
- Undermount or flush mount installation
- SoundSecure™ sound pads
- StoneLock™ undercoating
- Bottom grid included
- Waste fitting included
- Limited Lifetime Warranty

Nominal Dimensions:

22 in x 30 in x 9 in (558 mm x 762 mm x 228 mm)

Bowl Size:

27-1/4 in (wide) 16-1/2 in (front to back) 9 in (deep)



Description	Net Wt	SKU	Color	List Price
Pekoe® 30 x 22-Inch Stainless Steel Single-Bowl Farmhouse Kitchen Sink	33 lb 15.2 kg	18SB.9302200A.075	Stainless Steel	948

Separate Components:

Pekoe® 30-Inch Single Bowl Kitchen Sink Grid	4 lb 2.0 kg	7302361-401.0750A	Stainless Steel	141
Waste Fitting	0 lb 0.3 kg	9028000.075	Stainless Steel	33

▷ Parts Program (Non-Premier)



Pekoe® 35 x 18-Inch Stainless Steel Undermount Single Bowl Kitchen Sink

- 18 gauge stainless steel
- Fabricated single bowl
- 10 mm radius corners
- Extra deep 10" (254 mm) bowl
- Undermount sink
- SoundSecure™ sound pads
- StoneLock™ undercoating
- Bottom grid included
- Waste fitting included
- Sink clips Included

Nominal Dimensions:

18 in x 35 in x 10 in (457 mm x 889 mm x 254 mm)

Bowl Size:

33 in (wide) 16 in (front to back) 10 in (deep)



Description	Net Wt	SKU	Color	List Price
Pekoe® 35 x 18-Inch Stainless Steel Undermount Single-Bowl Kitchen Sink	27 lb 12.5 kg	18SB.10351800.075	Stainless Steel	901

Separate Components:

Pekoe® 35-Inch Single Bowl Kitchen Sink Grid	5 lb 2.6 kg	▷7302286-401.0750A	Stainless Steel	90
Undermount Sink Clips	0 lb 0.3 kg	▷791676-100.0070A	No Finish	13
Waste Fitting		9028000.075	Stainless Steel	33



Pekoe® 23 x 18-Inch Stainless Steel Undermount Single Bowl Kitchen Sink

- 18 gauge stainless steel
- Fabricated single bowl
- 10 mm radius corners
- Extra deep 10" (254 mm) bowl
- Undermount sink
- SoundSecure™ sound pads
- StoneLock™ undercoating
- Bottom grid included
- Waste fitting included
- Sink clips Included

Nominal Dimensions:

18 in x 23 in x 10 in (457 mm x 584 mm x 254 mm)

Bowl Size:

21 in (wide) 16 in (front to back) 10 in (deep)



Description	Net Wt	SKU	Color	List Price
Pekoe® 23 x 18-Inch Stainless Steel Undermount Single-Bowl Kitchen Sink	20 lb 9.2 kg	18SB.10231800.075	Stainless Steel	798

Separate Components:

Pekoe® 23-Inch Single Bowl Kitchen Sink Grid	2 lb 1.2 kg	▷7302282-401.0750A	Stainless Steel	69
Undermount Sink Clips	0 lb 0.3 kg	▷791676-100.0070A	No Finish	13
Waste Fitting		9028000.075	Stainless Steel	33

▷ Parts Program (Non-Premier)



Pekoe® 17 x 17-Inch Stainless Steel Undermount Single Bowl Kitchen Sink

- 18 gauge stainless steel
- Fabricated single bowl
- 10 mm radius corners
- 8" (203 mm) deep bowl
- Undermount sink
- SoundSecure™ sound pads
- StoneLock™ undercoating
- Bottom grid included
- Waste fitting included
- Sink clips Included

Nominal Dimensions:

17 in x 17 in x 8 in (431 mm x 431 mm x 203 mm)

Bowl Size:

15 in (wide) 15 in (front to back) 8 in (deep)



Description	Net Wt	SKU	Color	List Price
Pekoe® 17 x 17-Inch Stainless Steel Undermount Single-Bowl Kitchen Sink	14 lb 6.4 kg	18SB.8171700.075	Stainless Steel	666

Separate Components:

Pekoe® 17-Inch Single Bowl Kitchen Sink Grid	1 lb 0.8 kg	▷7302288-401.0750A	Stainless Steel	58
Undermount Sink Clips	0 lb 0.3 kg	▷791676-100.0070A	No Finish	13
Waste Fitting		9028000.075	Stainless Steel	33



Pekoe® 35 x 18-Inch Stainless Steel Undermount Double-Bowl Kitchen Sink

- 18 gauge stainless steel
- Fabricated double bowl
- 10 mm radius corners
- 9" (229 mm) deep bowls
- Undermount sink
- SoundSecure+™ sound pads
- StoneLock™ undercoating
- Two bottom grids included
- Two waste fittings included
- Sink clips included
- Includes (2) 9028000.075 Drains
- Installation hardware, cutout template and instructions included

Nominal Dimensions:

18 in x 35 in x 9 in (457 mm x 889 mm x 228 mm)

Bowl Size:

33 in (wide) 16 in (front to back) 9 in (deep)



Description	Net Wt	SKU	Color	List Price
Pekoe® 35 x 18-Inch Stainless Steel Undermount Double-Bowl Kitchen Sink	30 lb 13.9 kg	18DB.9351800.075	Stainless Steel	926

Separate Components:

Pekoe® 35-Inch Double Bowl Kitchen Sink Grid	4 lb 1.8 kg	▷7302285-401.0750A	No Finish	117
Undermount Sink Clips	0 lb 0.3 kg	▷791676-100.0070A	No Finish	13
Waste Fitting		9028000.075	Stainless Steel	33

▷ Parts Program (Non-Premier)



Pekoe® 35 x 18-Inch Stainless Steel Undermount Double-Bowl Kitchen Sink

- 18 gauge stainless steel
- Fabricated offset double bowls
- 10 mm radius corners
- 9" (229 mm) deep bowls
- Undermount sink
- SoundSecure+™ sound pads
- StoneLock™ undercoating
- Two bottom grids included
- Two waste fittings included
- Includes (2) 9028000.075 Drains
- Installation hardware, cutout template and instructions included

Nominal Dimensions:

18 in x 35 in x 9 in (457 mm x 889 mm x 228 mm)

Bowl Size:

21 in (wide) 16 in (front to back) 9 in (deep)



Description	Net Wt	SKU	Color	List Price
Pekoe® 35 x 18-Inch Stainless Steel Undermount Double-Bowl Kitchen Sink	31 lb 14.2 kg	18CR.9351800.075	Stainless Steel	926

Separate Components:

Pekoe® 35-Inch Combination Bowl Kitchen Sink Grid	4 lb 1.9 kg	▷7302298-401.0750A	No Finish	117
Undermount Sink Clips	0 lb 0.3 kg	▷791676-100.0070A	No Finish	13
Waste Fitting		9028000.075	Stainless Steel	33



Pekoe® 29 x 18-Inch Stainless Steel Undermount Double Bowl Kitchen Sink

- 18 gauge stainless steel
- Fabricated double bowl
- 10 mm radius corners
- 9" (229 mm) deep bowls
- Undermount sink
- SoundSecure+™ sound pads
- StoneLock™ undercoating
- Two bottom grids included
- Two waste fittings included
- Sink clips included
- Includes (2) 9028000.075 Drains
- Installation hardware, cutout template and instructions included

Nominal Dimensions:

18 in x 29 in x 9 in (457 mm x 736 mm x 228 mm)

Bowl Size:

13 in (wide) 16 in (front to back) 9 in (deep)



Description	Net Wt	SKU	Color	List Price
Pekoe® 29 x 18-Inch Stainless Steel Undermount Double Bowl Kitchen Sink	27 lb 12.3 kg	18DB.9291800.075	Stainless Steel	867

Separate Components:

Pekoe® 29-Inch Double Bowl Kitchen Sink Grid	3 lb 1.6 kg	▷7302287-401.0750A	Stainless Steel	96
Undermount Sink Clips	0 lb 0.3 kg	▷791676-100.0070A	No Finish	13
Waste Fitting		9028000.075	Stainless Steel	33

▷ Parts Program (Non-Premier)



Pekoe® 29 x 18-Inch Stainless Steel Undermount Double Bowl ADA Kitchen Sink

- 18 gauge stainless steel
- Fabricated double bowl
- 10 mm radius corners
- Offset drains
- 6" (152 mm) deep bowls
- Undermount sink
- SoundSecure+™ sound pads
- StoneLock™ undercoating
- Two bottom grids included
- Includes: - 7302287-401.0750A Bottom Grid Set - (2) 9028000.075 Waste Fittings - 791676-100.0070A Undermount Sink Clips - Cutout template - Installation Instructions

Nominal Dimensions:

18 in x 29 in x 6 in (457 mm x 736 mm x 152 mm)

Bowl Size:

27 in (wide) 16 in (front to back) 6 in (deep)



Description	Net Wt	SKU	Color	List Price
Pekoe® 29 x 18-Inch Stainless Steel Undermount Double-Bowl ADA Kitchen Sink	22 lb 10.4 kg	18DB6291800.075	Stainless Steel	836

Separate Components:

Pekoe® 29-Inch Double Bowl Kitchen Sink Grid	3 lb 1.6 kg	▷7302287-401.0750A	Stainless Steel	96
Undermount Sink Clips	0 lb 0.3 kg	▷791676-100.0070A	No Finish	13
Waste Fitting		9028000.075	Stainless Steel	33

▷ Parts Program (Non-Premier)



Edgewater® 33 x 22-Inch Stainless Steel 1-Hole Dual Mount Single Bowl Kitchen Sink

- 18 gauge stainless steel
- Fabricated single bowl sink
- 9" (229 mm) deep bowl
- Dual mount sink (top or under)
- Zero radius corners
- SoundSecure+™ sound pads
- StoneLock™ undercoating
- Bottom grid included
- Waste fitting included
- 36" (914 mm) cabinet required

Nominal Dimensions:

22 in x 33 in x 9 in (558 mm x 838 mm x 228 mm)

Bowl Size:

30-1/4 in (wide) 16-1/2 in (front to back) 9 in (deep)



Description	Net Wt	SKU	Color	List Price
Edgewater® 33 x 22-Inch Stainless Steel 1-Hole Dual Mount Single-Bowl Kitchen Sink	28 lb 12.7 kg	18SB.9332211.075	Stainless Steel	705

Separate Components:

16 x 29-Inch Stainless Steel Kitchen Sink Grid	2 lb 1.0 kg	7434000.075	Stainless Steel	199
Undermount Sink Clips	0 lb 0.3 kg	▷791676-100.0070A	No Finish	13
Top Mount Sink Clips	0 lb 0.2 kg	▷791637-100.0070A	No Finish	13
Waste Fitting	0 lb 0.3 kg	9028000.075	Stainless Steel	33



Edgewater® 33 x 22-Inch Stainless Steel 1-Hole Dual Mount Single Bowl ADA Kitchen Sink

- 18 gauge stainless steel
- Fabricated single bowl
- 6" (152 mm) deep bowl
- Offset drain
- Dual mount sink (top or under)
- Zero radius corners
- SoundSecure+™ sound pads
- StoneLock™ undercoating
- Bottom grid included
- 36" (914 mm) cabinet required

Nominal Dimensions:

22 in x 33 in x 6 in (558 mm x 838 mm x 152 mm)

Bowl Size:

30-1/4 in (wide) 16-9/16 in (front to back) 6 in (deep)



Description	Net Wt	SKU	Color	List Price
Edgewater® 33 x 22-Inch Stainless Steel 1-Hole Dual Mount Single-Bowl ADA Kitchen Sink	24 lb 11.2 kg	18SB6332211.075	Stainless Steel	692

Separate Components:

16 x 29-Inch Stainless Steel Kitchen Sink Grid	2 lb 1.0 kg	7434000.075	Stainless Steel	199
Undermount Sink Clips	0 lb 0.3 kg	▷791676-100.0070A	No Finish	13
Top Mount Sink Clips	0 lb 0.2 kg	▷791637-100.0070A	No Finish	13
Waste Fitting	0 lb 0.3 kg	9028000.075	Stainless Steel	33

▷ Parts Program (Non-Premier)



Edgewater® 25 x 22-Inch Stainless Steel 1-Hole Undermount Single Bowl Kitchen Sink

- 18 gauge stainless steel
- Fabricated single bowl sink
- 9" (229 mm) deep bowl
- Dual mount sink (top or under)
- Zero radius corners
- SoundSecure+™ sound pads
- StoneLock™ undercoating
- Bottom grid included
- Waste fitting included
- 27" (686 mm) cabinet required

Nominal Dimensions:

22 in x 25 in x 9 in (558 mm x 635 mm x 228 mm)

Bowl Size:

22-1/4 in (wide) 16-1/2 in (front to back) 9 in (deep)



Description	Net Wt	SKU	Color	List Price
Edgewater® 25 x 22-Inch Stainless Steel 1-Hole Undermount Single-Bowl Kitchen Sink	23 lb 10.5 kg	18SB.9252211.075	Stainless Steel	666

Separate Components:

Edgewater® 25-Inch Single Bowl Kitchen Sink Grid	2 lb 1.0 kg	▷7302289-401.0750A	Stainless Steel	73
Undermount Sink Clips	0 lb 0.3 kg	▷791676-100.0070A	No Finish	13
Top Mount Sink Clips	0 lb 0.2 kg	▷791637-100.0070A	No Finish	13
Waste Fitting	0 lb 0.3 kg	9028000.075	Stainless Steel	33



Edgewater® 25 x 22-Inch Stainless Steel 1-Hole Dual Mount Single Bowl ADA Kitchen Sink

- 18 gauge stainless steel
- Fabricated single bowl
- 6" (152 mm) deep bowl
- Offset drain
- Dual mount sink (top or under)
- Zero radius corners
- SoundSecure+™ sound pads
- StoneLock™ undercoating
- Waste fitting included
- 29" (737 mm) cabinet required

Nominal Dimensions:

22 in x 25 in x 6 in (558 mm x 635 mm x 152 mm)

Bowl Size:

22-1/4 in (wide) 16-9/16 in (front to back) 6 in (deep)



Description	Net Wt	SKU	Color	List Price
Edgewater® 25 x 22-Inch Stainless Steel 1-Hole Dual Mount Single-Bowl ADA Kitchen Sink	20 lb 9.1 kg	18SB6252211.075	Stainless Steel	720

Separate Components:

Edgewater® 25-Inch Single Bowl Kitchen Sink Grid	2 lb 1.0 kg	▷7302289-401.0750A	Stainless Steel	73
Undermount Sink Clips	0 lb 0.3 kg	▷791676-100.0070A	No Finish	13
Top Mount Sink Clips	0 lb 0.2 kg	▷791637-100.0070A	No Finish	13
Waste Fitting	0 lb 0.3 kg	9028000.075	Stainless Steel	33

▷ Parts Program (Non-Premier)



Edgewater® 33 x 22-Inch Stainless Steel 1-Hole Dual Mount Double-Bowl Kitchen Sink

- 18 gauge stainless steel
- Fabricated double bowl
- 9" (229 mm) deep bowls
- Dual mount sink (top or under)
- Zero radius corners
- SoundSecure™ sound pads
- StoneLock™ undercoating
- Two bottom grids included
- Two waste fittings included
- 36" (914 mm) cabinet required

Nominal Dimensions:

22 in x 33 in x 9 in (558 mm x 838 mm x 228 mm)

Bowl Size:

14-5/8 in (wide) 16-5/8 in (front to back) 9 in (deep)



Description	Net Wt	SKU	Color	List Price
Edgewater® 33 x 22-Inch Stainless Steel 1-Hole Dual Mount Double-Bowl Kitchen Sink	33 lb 15.0 kg	18DB.9332211.075	Stainless Steel	728

Separate Components:

Edgewater® 25-Inch Double Bowl Kitchen Sink Grid	3 lb 1.7 kg	▷7302290-401.0750A	Stainless Steel	155
Undermount Sink Clips	0 lb 0.3 kg	▷791676-100.0070A	No Finish	13
Top Mount Sink Clips	0 lb 0.2 kg	▷791637-100.0070A	No Finish	13
Waste Fitting	0 lb 0.3 kg	9028000.075	Stainless Steel	33



Edgewater® 33 x 22-Inch Stainless Steel 1-Hole Dual Mount Double Bowl ADA Kitchen Sink

- 18 gauge stainless steel
- Fabricated double bowl
- 6" (152 mm) deep bowls
- Offset drain
- Dual mount sink (top or under)
- Zero radius corners
- SoundSecure™ sound pads
- StoneLock™ undercoating
- Two bottom grids included
- 36" (914 mm) cabinet required

Nominal Dimensions:

22 in x 32-11/16 in x 6 in (558 mm x 830 mm x 152 mm)

Bowl Size:

30-1/4 in (wide) 16-9/16 in (front to back) 6 in (deep)



Description	Net Wt	SKU	Color	List Price
Edgewater® 33 x 22-Inch Stainless Steel 1-Hole Dual Mount Double-Bowl ADA Kitchen Sink	29 lb 13.3 kg	18DB6332211.075	Stainless Steel	765

Separate Components:

Edgewater® 25-Inch Double Bowl Kitchen Sink Grid	3 lb 1.7 kg	▷7302290-401.0750A	Stainless Steel	155
Undermount Sink Clips	0 lb 0.3 kg	▷791676-100.0070A	No Finish	13
Top Mount Sink Clips	0 lb 0.2 kg	▷791637-100.0070A	No Finish	13
Waste Fitting	0 lb 0.3 kg	9028000.075	Stainless Steel	33

▷ Parts Program (Non-Premier)



Portsmouth® 30 x 18-Inch Stainless Steel Undermount Single Bowl Kitchen Sink

- 18 gauge stainless steel
- Stamped single bowl
- 9" (229 mm) deep bowl
- Undermount sink
- SoundSecure+™ sound pads
- StoneLock™ undercoating
- Waste fitting included
- Sink clips included
- Includes 9028000.075 drain
- 36" (914 mm) cabinet required

Nominal Dimensions:

18 in x 30 in x 9 in (457 mm x 762 mm x 228 mm)

Bowl Size:

27-3/4 in (wide) 16-1/4 in (front to back) 9 in (deep)



Description	Net Wt	SKU	Color	List Price
Portsmouth® 30 x 18-Inch Stainless Steel Undermount Single-Bowl Kitchen Sink	13 lb 6.3 kg	18SB.9301800S.075	Stainless Steel	666

Separate Components:

Undermount Sink Clips	0 lb 0.3 kg	▷791676-100.0070A	No Finish	13
Waste Fitting		9028000.075	Stainless Steel	33

Optional Components:

Portsmouth Bottom Sink Grid 30 x 18-In.	2 lb 1.1 kg	8459.301800.075	Stainless Steel	161
---	----------------	-----------------	-----------------	-----



Portsmouth® 30 x 18-Inch Stainless Steel Undermount Single Bowl ADA Kitchen Sink

- 18 gauge stainless steel
- Stamped single bowl
- 6" (152 mm) deep bowl
- Offset drain
- Undermount sink
- SoundSecure+™ sound pads
- StoneLock™ undercoating
- Waste fitting included
- Sink clips included
- 33" (838 mm) cabinet required

Nominal Dimensions:

18 in x 29-3/4 in x 6 in (457 mm x 755 mm x 152 mm)

Bowl Size:

27-3/4 in (wide) 16-1/8 in (front to back) 6 in (deep)



Description	Net Wt	SKU	Color	List Price
Portsmouth® 30 x 18-Inch Stainless Steel Undermount Single-Bowl ADA Kitchen Sink	12 lb 5.8 kg	18SB6301800S.075	Stainless Steel	621

Separate Components:

Undermount Sink Clips	0 lb 0.3 kg	▷791676-100.0070A	No Finish	13
Waste Fitting		9028000.075	Stainless Steel	33

Optional Components:

Portsmouth Bottom Sink Grid 30 x 18-In.	2 lb 1.1 kg	8459.301800.075	Stainless Steel	161
---	----------------	-----------------	-----------------	-----

▷ Parts Program (Non-Premier)



Portsmouth® 23 x 18-Inch Stainless Steel Undermount Single Bowl Kitchen Sink

- 18 gauge stainless steel
- Stamped single bowl
- 9" (229 mm) deep bowl
- Undermount sink - can be reveal or flush
- SoundSecure+™ sound pads
- StoneLock™ undercoating
- Waste fitting included
- Sink clips included
- Includes 9028000.075 drain
- 30" (762 mm) cabinet required

Nominal Dimensions:

17-3/4 in x 23-3/8 in x 9-1/16 in (450 mm x 593 mm x 230 mm)

Bowl Size:

21-7/16 in (wide) 15-3/4 in (front to back) 9 in (deep)



Description	Net Wt	SKU	Color	List Price
Portsmouth® 23 x 18-Inch Stainless Steel Undermount Single-Bowl Kitchen Sink	10 lb 4.9 kg	18SB.9231800S.075	Stainless Steel	533

Separate Components:

Undermount Sink Clips	0 lb 0.3 kg	▶791676-100.0070A	No Finish	13
Waste Fitting		9028000.075	Stainless Steel	33

Optional Components:

Portsmouth Bottom Sink Grid 23 x 18-In.	1 lb 0.9 kg	8452.231700.075	Stainless Steel	140
---	----------------	-----------------	-----------------	-----



Portsmouth® 23 x 18-Inch Stainless Steel Undermount Single Bowl ADA Kitchen Sink

- 18 gauge stainless steel
- Stamped single bowl
- 6" (152 mm) deep bowl
- Undermount sink
- SoundSecure+™ sound pads
- StoneLock™ undercoating
- Waste fitting included
- Sink clips included
- 26" (660 mm) cabinet required
- Cutout template and instructions included

Nominal Dimensions:

17-3/4 in x 23-3/8 in x 6 in (450 mm x 593 mm x 152 mm)

Bowl Size:

21-7/16 in (wide) 15-13/16 in (front to back) 6 in (deep)



Description	Net Wt	SKU	Color	List Price
Portsmouth® 23 x 18-Inch Stainless Steel Undermount Single-Bowl ADA Kitchen Sink	9 lb 4.1 kg	18SB6231800S.075	Stainless Steel	495

Separate Components:

Undermount Sink Clips	0 lb 0.3 kg	▶791676-100.0070A	No Finish	13
Waste Fitting		9028000.075	Stainless Steel	33

▶ Parts Program (Non-Premier)



Portsmouth® 23 x 21-Inch Stainless Steel Undermount Single Bowl Kitchen Sink

- 18 gauge stainless steel
- Stamped single bowl
- 9" (229 mm) deep bowl
- Undermount sink
- SoundSecure+™ sound pads
- StoneLock™ undercoating
- Waste fitting included
- Sink clips included
- Includes 9028000.075 drain
- 30" (762 mm) cabinet required

Nominal Dimensions:

21 in x 23 in x 8 in (533 mm x 584 mm x 203 mm)

Bowl Size:

18-7/8 in (wide) 21-1/4 in (front to back) 9 in (deep)



Description	Net Wt	SKU	Color	List Price
Portsmouth® 23 x 21-Inch Stainless Steel Undermount Single-Bowl Kitchen Sink	11 lb 5.1 kg	18SB.9232100S.075	Stainless Steel	560

Separate Components:

Undermount Sink Clips	0 lb 0.3 kg	▷791676-100.0070A	No Finish	13
Waste Fitting		9028000.075	Stainless Steel	33

Optional Components:

Portsmouth Bottom Sink Grid 23 x 21-In.	2 lb 1.0 kg	8449.232100D.075	Stainless Steel	126
---	----------------	------------------	-----------------	-----



Portsmouth® 18 x 16-Inch Stainless Steel Undermount Single Bowl Kitchen Sink

- 18 gauge stainless steel
- Stamped single bowl
- 9" (229 mm) deep bowl
- Undermount sink
- SoundSecure+™ sound pads
- StoneLock™ undercoating
- Waste fitting included
- Sink clips included
- Includes 9028000.075 drain
- 21" (533 mm) cabinet required

Nominal Dimensions:

15-15/16 in x 17-13/16 in x 9 in (404 mm x 452 mm x 228 mm)

Bowl Size:

15-13/16 in (wide) 13-15/16 in (front to back) 9 in (deep)



Description	Net Wt	SKU	Color	List Price
Portsmouth® 18 x 16-Inch Stainless Steel Undermount Single-Bowl Kitchen Sink	8 lb 3.8 kg	18SB.9181600S.075	Stainless Steel	507

Separate Components:

Undermount Sink Clips	0 lb 0.3 kg	▷791676-100.0070A	No Finish	13
Waste Fitting		9028000.075	Stainless Steel	33

Optional Components:

Portsmouth Bottom Sink Grid 16 x 18-In.	1 lb 0.6 kg	8448.181600.075	Stainless Steel	126
---	----------------	-----------------	-----------------	-----

▷ Parts Program (Non-Premier)



Portsmouth® 18 x 16-Inch Stainless Steel Undermount Single Bowl ADA Kitchen Sink

- 18 gauge stainless steel
- Stamped single bowl
- 6" (152 mm) deep bowl
- Undermount sink
- SoundSecure+™ sound pads
- StoneLock™ undercoating
- Waste fitting included
- Sink clips included
- 21" (533 mm) cabinet required
- Cutout template and instructions included

Nominal Dimensions:

15-15/16 in x 17-13/16 in x 6 in (404 mm x 452 mm x 152 mm)

Bowl Size:

15-7/8 in (wide) 13-15/16 in (front to back) 6 in (deep)



Description	Net Wt	SKU	Color	List Price
Portsmouth® 18 x 16-Inch Stainless Steel Undermount Single-Bowl ADA Kitchen Sink	7 lb 3.3 kg	18SB6181600S.075	Stainless Steel	471

Separate Components:

Undermount Sink Clips	0 lb 0.3 kg	▶791676-100.0070A	No Finish	13
Waste Fitting		9028000.075	Stainless Steel	33

Optional Components:

Portsmouth Bottom Sink Grid 16 x 18-In.	1 lb 0.6 kg	8448.181600.075	Stainless Steel	126
---	----------------	-----------------	-----------------	-----



Portsmouth® 16 x 16-Inch Stainless Steel Undermount Round Single Bowl Kitchen Sink

- 18 gauge stainless steel
- Stamped single bowl
- 7" (178 mm) deep bowl
- Undermount sink
- SoundSecure+™ sound pads
- StoneLock™ undercoating
- Waste fitting included
- Sink clips included
- Includes drain and strainer
- Limited Lifetime warranty on sink - 1 year Limited warranty on all accessories

Nominal Dimensions:

16-3/8 in x 16-3/8 in x 7 in (415 mm x 415 mm x 177 mm)

Bowl Size:

14-1/4 in (wide) 14-1/4 in (front to back) 7 in (deep)



Description	Net Wt	SKU	Color	List Price
Portsmouth® 16 x 16-Inch Stainless Steel Undermount Round Single-Bowl Kitchen Sink	6 lb 3.0 kg	18SB.7001600S.075	Stainless Steel	400

Separate Components:

Undermount Sink Clips	0 lb 0.3 kg	▶791676-100.0070A	No Finish	13
Waste Fitting		9028000.075	Stainless Steel	33

Optional Components:

Portsmouth® 16-Inch Round Bar Sink Grid	1 lb 0.5 kg	8442.001600.075	Stainless Steel	112
---	----------------	-----------------	-----------------	-----

▶ Parts Program (Non-Premier)



Portsmouth® 32 x 18-Inch Stainless Steel Undermount Double-Bowl Kitchen Sink

- 18 gauge stainless steel
- Stamped double bowl
- 9" (229 mm) deep bowls
- Undermount sink
- SoundSecure™ sound pads
- StoneLock™ undercoating
- Two waste fittings included
- Sink clips included
- Includes (2) 9028000.075 drains
- 36" (914 mm) cabinet required

Nominal Dimensions:

18-1/2 in x 32-1/4 in x 9 in (469 mm x 819 mm x 228 mm)

Bowl Size:

14-5/8 in (wide) 16-5/8 in (front to back) 9 in (deep)



Description	Net Wt	SKU	Color	List Price
Portsmouth® 32 x 18-Inch Stainless Steel Undermount Double-Bowl Kitchen Sink	14 lb 6.6 kg	18DB.9311800S.075	Stainless Steel	733

Separate Components:

Undermount Sink Clips	0 lb 0.3 kg	▷791676-100.0070A	No Finish	13
Waste Fitting		9028000.075	Stainless Steel	33

Optional Components:

Portsmouth Bottom Sink Grid 32 x 18-In.	1 lb 0.6 kg	8447.311800.075	Stainless Steel	107
---	----------------	-----------------	-----------------	-----



Portsmouth® 32 x 18-Inch Stainless Steel Undermount Double Bowl ADA Kitchen Sink

- 18 gauge stainless steel
- Stamped double bowl
- 6" (152 mm) deep bowls
- Offset drain
- Undermount sink
- SoundSecure™ sound pads
- StoneLock™ undercoating
- Two waste fittings included
- Sink clips included
- 36" (914 mm) cabinet required

Nominal Dimensions:

18-1/2 in x 32-5/16 in x 6 in (469 mm x 820 mm x 152 mm)

Bowl Size:

14-3/4 in (wide) 16-5/8 in (front to back) 6 in (deep)



Description	Net Wt	SKU	Color	List Price
Portsmouth® 32 x 18-Inch Stainless Steel Undermount Double-Bowl ADA Kitchen Sink	13 lb 6.3 kg	18DB6311800S.075	Stainless Steel	647

Separate Components:

Undermount Sink Clips	0 lb 0.3 kg	▷791676-100.0070A	No Finish	13
Waste Fitting		9028000.075	Stainless Steel	33

Optional Components:

Portsmouth Bottom Sink Grid 32 x 18-In.	1 lb 0.6 kg	8447.311800.075	Stainless Steel	107
---	----------------	-----------------	-----------------	-----

▷ Parts Program (Non-Premier)



Portsmouth® 32 x 21-Inch Stainless Steel Undermount Double-Bowl Kitchen Sink

- 18 gauge stainless steel
- Stamped offset double bowl
- 9" (229 mm) deep bowl (left)
- 7-1/2" (191 mm) deep bowl (right)
- Undermount sink
- SoundSecure™ sound pads
- StoneLock™ undercoating
- Two waste fittings included
- Sink clips included
- 36" (914 mm) cabinet required

Nominal Dimensions:

20-1/2 in x 31-1/2 in x 9 in (520 mm x 800 mm x 228 mm)

Bowl Size:

15-1/2 in (wide) 18-5/8 in (front to back) 9 in (deep)



Description	Net Wt	SKU	Color	List Price
Portsmouth® 32 x 21-Inch Stainless Steel Undermount Double-Bowl Kitchen Sink	15 lb 6.9 kg	18CR.9322100S.075	Stainless Steel	733
Separate Components:				
Undermount Sink Clips	0 lb 0.3 kg	▶791676-100.0070A	No Finish	13
Waste Fitting		9028000.075	Stainless Steel	33
Optional Components:				
Portsmouth Left Side Sink Grid 32-Inch	1 lb 0.8 kg	8446.312000L.075	Stainless Steel	107
Portsmouth Right Side Sink Grid 32-Inch	1 lb 0.6 kg	8446.312000S.075	Stainless Steel	93

▶ Parts Program (Non-Premier)



Reliant® 30 x 18-Inch Stainless Steel Undermount Single Bowl Kitchen Sink

- 18 gauge stainless steel
- Stamped single bowl
- 9" (229 mm) deep bowl
- Undermount sink
- SoundSecure+™ sound pads
- StoneLock™ undercoating
- Waste fitting included
- Sink clips included
- Includes 9028000.075 drain
- 36" (914 mm) cabinet required

Nominal Dimensions:

18 in x 30 in x 9 in (457 mm x 762 mm x 228 mm)

Bowl Size:

30 in (wide) 15-15/16 in (front to back) 9 in (deep)



Description	Net Wt	SKU	Color	List Price
Reliant® 30 x 18-Inch Stainless Steel Undermount Single-Bowl Kitchen Sink	13 lb 6.1 kg	18SB.9301800T.075	Stainless Steel	400

Separate Components:

Undermount Sink Clips	0 lb 0.3 kg	▷791676-100.0070A	No Finish	13
Waste Fitting		9028000.075	Stainless Steel	33



Reliant® 32 x 18-Inch Stainless Steel Undermount Double Bowl Kitchen Sink

- 18 gauge stainless steel
- Stamped double bowl
- 9" (229 mm) deep bowls
- Undermount sink
- SoundSecure™ sound pads
- StoneLock™ undercoating
- Two waste fittings included
- Sink clips included
- Includes (2) 9028000.075 drains
- 36" (914 mm) cabinet required

Nominal Dimensions:

18 in x 32 in x 9 in (457 mm x 812 mm x 228 mm)

Bowl Size:

28-7/8 in (wide) 16 in (front to back) 9 in (deep)



Description	Net Wt	SKU	Color	List Price
Reliant® 32 x 18-Inch Stainless Steel Undermount Double-Bowl Kitchen Sink	14 lb 6.6 kg	18DB.9321800T.075	Stainless Steel	434

Separate Components:

Undermount Sink Clips	0 lb 0.3 kg	▷791676-100.0070A	No Finish	13
Waste Fitting		9028000.075	Stainless Steel	33

▷ Parts Program (Non-Premier)



Reliant® 31 x 20-Inch Stainless Steel Undermount Double Bowl Kitchen Sink

- 18 gauge stainless steel
- Stamped offset double bowl
- 9" (229 mm) deep bowls
- Undermount sink
- SoundSecure™ sound pads
- StoneLock™ undercoating
- Sink clips included
- Includes (2) 9028000.075 drains
- 36" (914 mm) cabinet required

Nominal Dimensions:

20 in x 31 in x 9 in (508 mm x 787 mm x 228 mm)

Bowl Size:

15-5/16 in (wide) 18 in (front to back) 7-1/2 in (deep)



Description	Net Wt	SKU	Color	List Price
Reliant® 31 x 20-Inch Stainless Steel Undermount Double-Bowl Kitchen Sink	15 lb 6.9 kg	18CR.9312000T.075	Stainless Steel	434

Separate Components:

Undermount Sink Clips	0 lb 0.3 kg	▷791676-100.0070A	No Finish	13
Waste Fitting		9028000.075	Stainless Steel	33

Optional Components:

Stainless Steel Kitchen Sink Grid – Pack of 2	2 lb 0.9 kg	7433000.075	Stainless Steel	215
---	----------------	-------------	-----------------	-----



Colony® 25 x 22-Inch Stainless Steel Single Bowl Kitchen Sink With Colony® PRO Single Control Faucet System

- 20 gauge stainless steel
- Stamped single bowl
- 8" (203 mm) deep bowl
- Top mount 3-hole sink
- SoundSecure+™ sound pads
- StoneLock™ undercoating
- Waste fitting & sink clips included
- 27" (686mm) cabinet required

Nominal Dimensions:

22-1/16 in x 25 in x 8 in (560 mm x 635 mm x 203 mm)

Bowl Size:

15-3/4 in (wide) 21-1/4 in (front to back) 8 in (deep)



Description	Net Wt	SKU	Color	List Price
Colony® 25 x 22-Inch Stainless Steel Single-Bowl Kitchen Sink With Colony® PRO Single Control Faucet System	13 lb 6.0 kg	20SB.8252283C.075	Stainless Steel	441

Separate Components:

Colony® 25 x 22-Inch Stainless Steel 3-Hole Topmount Single-Bowl Kitchen Sink	10 lb 4.7 kg	20SB.8252283S.075	Stainless Steel	327
Colony® PRO Single-Handle Kitchen Faucet 1.5 gpm/5.7 L/min	3 lb 1.5 kg	7074000.075	Stainless Steel	186
Top Mount Sink Clips	0 lb 0.2 kg	▷791637-100.0070A	No Finish	13
Waste Fitting	0 lb 0.3 kg	9028000.075	Stainless Steel	33



Colony® 25 x 22-Inch Stainless Steel Single Bowl ADA Kitchen Sink With Colony® PRO Single Control Faucet System

- 22 gauge stainless steel
- Stamped single bowl
- 6" (152 mm) deep bowl
- Top mount 3-hole sink
- SoundSecure+™ sound pads
- StoneLock™ undercoating
- Waste fitting & sink clips included
- 27" (686 mm) cabinet required

Nominal Dimensions:

22 in x 25 in x 6 in (558 mm x 635 mm x 152 mm)

Bowl Size:

15-3/4 in (wide) 21-1/4 in (front to back) 6 in (deep)



Description	Net Wt	SKU	Color	List Price
Colony® 25 x 22-Inch Stainless Steel Single-Bowl ADA Kitchen Sink With Colony® PRO Single Control Faucet System	11 lb 5.2 kg	22SB.6252283C.075	Stainless Steel	394

Separate Components:

Colony® 25 x 22-Inch Stainless Steel 3-Hole Top Mount Single-Bowl ADA Kitchen Sink	8 lb 3.8 kg	22SB.6252283S.075	Stainless Steel	268
Colony® PRO Single-Handle Kitchen Faucet 1.5 gpm/5.7 L/min	3 lb 1.5 kg	7074000.075	Stainless Steel	186
Top Mount Sink Clips	0 lb 0.2 kg	▷791637-100.0070A	No Finish	13
Waste Fitting	0 lb 0.3 kg	9028000.075	Stainless Steel	33

▷ Parts Program (Non-Premier)



Colony® 33 x 22-Inch Stainless Steel 3-Hole Top Mount Double Bowl Kitchen Sink With Colony® PRO Single Control Faucet System

- 20 gauge stainless steel
- Stamped double bowl
- 8" (203 mm) deep bowls
- Top mount 3-hole sink
- SoundSecure™ sound pads
- StoneLock™ undercoating
- Two waste fittings & sink clips included
- 36" (914 mm) cabinet required

Nominal Dimensions:

21-15/16 in x 32-15/16 in x 8 in (557 mm x 836 mm x 203 mm)

Bowl Size:

16 in (wide) 14 in (front to back) 8 in (deep)



Description	Net Wt	SKU	Color	List Price
Colony® 33 x 22-Inch Stainless Steel 3-Hole Topmount Double-Bowl Kitchen Sink With Colony® PRO Single Control Faucet System	18 lb 8.5 kg	20DB.8332283C.075	Stainless Steel	486

Separate Components:

Colony® 33 x 22-Inch Stainless Steel 3-Hole Topmount Double-Bowl Kitchen Sink	15 lb 7.1 kg	20DB.8332283S.075	Stainless Steel	347
Colony® PRO Single-Handle Kitchen Faucet 1.5 gpm/5.7 L/min	3 lb 1.5 kg	7074000.075	Stainless Steel	186
Top Mount Sink Clips	0 lb 0.2 kg	▷791637-100.0070A	No Finish	13
Waste Fitting	0 lb 0.3 kg	9028000.075	Stainless Steel	33



Colony® 33 x 22-Inch Stainless Steel 3-Hole Top Mount Double Bowl ADA Kitchen Sink With Colony® PRO Single Control Faucet System

- 20 gauge stainless steel
- Stamped double bowl
- 6" (152 mm) deep bowls
- Top mount 3-hole sink
- SoundSecure™ sound pads
- StoneLock™ undercoating
- Two waste fittings and sink clips included
- 36" (914 mm) cabinet required

Nominal Dimensions:

21-15/16 in x 32-15/16 in x 6 in (557 mm x 836 mm x 152 mm)

Bowl Size:

16 in (wide) 14 in (front to back) 6 in (deep)



Description	Net Wt	SKU	Color	List Price
Colony® 33 x 22-Inch Stainless Steel 3-Hole Top Mount Double-Bowl ADA Kitchen Sink With Colony® PRO Single Control Faucet System	14 lb 6.4 kg	22DB.6332283C.075	Stainless Steel	446

Separate Components:

Colony® 33 x 22-Inch Stainless Steel 3-Hole Top Mount Double-Bowl ADA Kitchen Sink	11 lb 5.1 kg	22DB.6332283S.075	Stainless Steel	305
Colony® PRO Single-Handle Kitchen Faucet 1.5 gpm/5.7 L/min	3 lb 1.5 kg	7074000.075	Stainless Steel	186
Top Mount Sink Clips	0 lb 0.2 kg	▷791637-100.0070A	No Finish	13
Waste Fitting	0 lb 0.3 kg	9028000.075	Stainless Steel	33

▷ Parts Program (Non-Premier)



Colony® 25 x 22-Inch Stainless Steel 3-Hole Top Mount Single Bowl Kitchen Sink

- 20 gauge stainless steel
- Stamped single bowl
- 8" (203 mm) deep bowl
- Top mount sink
- SoundSecure+™ sound pads
- StoneLock™ undercoating
- Waste fitting & sink clips included
- 27" (686 mm) cabinet required

Nominal Dimensions:

22-1/16 in x 25 in x 8 in (560 mm x 635 mm x 203 mm)

Bowl Size:

21-3/8 in (wide) 15-11/16 in (front to back) 8 in (deep)



Description	Net Wt	SKU	Color	List Price
Colony® 25 x 22-Inch Stainless Steel 3-Hole Topmount Single-Bowl Kitchen Sink	10 lb 4.7 kg	20SB.8252283S.075	Stainless Steel	327

Separate Components:

Top Mount Sink Clips	0 lb 0.2 kg	▷791637-100.0070A	No Finish	13
Waste Fitting	0 lb 0.3 kg	9028000.075	Stainless Steel	33



Colony® 25 x 22-Inch Stainless Steel 4-Hole Top Mount Single Bowl Kitchen Sink

- 20-gauge stainless steel
- Stamped single bowl
- 8" (203 mm) deep bowl
- Top mount sink
- SoundSecure+™ sound pads
- StoneLock™ undercoating
- Waste fitting & sink clips included
- 27" (686 mm) cabinet required

Nominal Dimensions:

25 in x 22 in x 8 in (635 mm x 558 mm x 203 mm)

Bowl Size:

21-3/4 in (wide) 15-3/4 in (front to back) 8 in (deep)



Description	Net Wt	SKU	Color	List Price
Colony® 25 x 22-Inch Stainless Steel 4-Hole Topmount Single-Bowl Kitchen Sink	10 lb 4.7 kg	20SB.8252284S.075	Stainless Steel	327

▷ Parts Program (Non-Premier)



Colony® 25 x 22-Inch Stainless Steel 3-Hole Top Mount Single Bowl ADA Kitchen Sink

- 22 gauge stainless steel
- Stamped single bowl
- 6" (152 mm) deep bowl
- Top mount sink
- SoundSecure+™ sound pads
- StoneLock™ undercoating
- Waste fitting & sink clips included
- 27" (686 mm) cabinet required

Nominal Dimensions:

22-1/16 in x 25 in x 6 in (560 mm x 635 mm x 152 mm)

Bowl Size:

21-1/4 in (wide) 15-1/8 in (front to back) 6 in (deep)



Description	Net Wt	SKU	Color	List Price
Colony® 25 x 22-Inch Stainless Steel 3-Hole Top Mount Single-Bowl ADA Kitchen Sink	8 lb 3.8 kg	22SB.6252283S.075	Stainless Steel	268

Separate Components:

Top Mount Sink Clips	0 lb 0.2 kg	▷791637-100.0070A	No Finish	13
Waste Fitting	0 lb 0.3 kg	9028000.075	Stainless Steel	33



Colony® 25 x 22-Inch Stainless Steel 4-Hole Top Mount Single Bowl ADA Kitchen Sink

- 20-gauge stainless steel
- Stamped single bowl
- 6" (152 mm) deep bowl
- Top mount sink
- SoundSecure+™ sound pads
- Waste fitting & sink clips included
- 27" (686 mm) cabinet required

Nominal Dimensions:

22 in x 25 in x 6 in (558 mm x 635 mm x 152 mm)

Bowl Size:

21-1/4 in (wide) 15-1/8 in (front to back) 6 in (deep)



Description	Net Wt	SKU	Color	List Price
Colony® 25 x 22-Inch Stainless Steel 4-Hole Top Mount Single-Bowl ADA Kitchen Sink	8 lb 3.8 kg	22SB.6252284S.075	Stainless Steel	268

▷ Parts Program (Non-Premier)



Colony® 33 x 22-Inch Stainless Steel 3-Hole Top Mount Double Bowl Kitchen Sink

- 20 gauge stainless steel
- Stamped double bowl
- 8" (203 mm) deep bowls
- Top mount sink
- SoundSecure™ sound pads
- StoneLock™ undercoating
- Two waste fittings included
- Sink clips included
- Includes (2) 9028000.075 drains
- 36" (914 mm) cabinet required

Nominal Dimensions:

21-15/16 in x 32-15/16 in x 8 in (557 mm x 836 mm x 203 mm)

Bowl Size:

14 in (wide) 15-15/16 in (front to back) 8 in (deep)



Description	Net Wt	SKU	Color	List Price
Colony® 33 x 22-Inch Stainless Steel 3-Hole Topmount Double-Bowl Kitchen Sink	15 lb 7.1 kg	20DB.8332283S.075	Stainless Steel	347

Separate Components:

Top Mount Sink Clips	0 lb 0.2 kg	▷791637-100.0070A	No Finish	13
Waste Fitting	0 lb 0.3 kg	9028000.075	Stainless Steel	33



Colony® 33 x 22-Inch Stainless Steel 4-Hole Top Mount Double Bowl Kitchen Sink

- 20-gauge stainless steel
- Stamped double bowl
- 8" (203 mm) deep bowls
- Top mount sink
- SoundSecure™ sound pads
- StoneLock™ undercoating
- Two waste fittings included
- Sink clips included
- Includes (2) 9028000.075 drains
- 36" (914 mm) cabinet required

Nominal Dimensions:

32-15/16 in x 21-15/16 in x 8 in (836 mm x 557 mm x 203 mm)

Bowl Size:

14 in (wide) 15-15/16 in (front to back) 8 in (deep)



Description	Net Wt	SKU	Color	List Price
Colony® 33 x 22-Inch Stainless Steel 4-Hole Topmount Double-Bowl Kitchen Sink	15 lb 7.1 kg	20DB.8332284S.075	Stainless Steel	347

Separate Components:

Top Mount Sink Clips	0 lb 0.2 kg	▷791637-100.0070A	No Finish	13
Waste Fitting	0 lb 0.3 kg	9028000.075	Stainless Steel	33

▷ Parts Program (Non-Premier)



Colony® 33 x 22-Inch Stainless Steel 3-Hole Top Mount Double Bowl ADA Kitchen Sink

- 20 gauge stainless steel
- Stamped double bowl
- 6" (152 mm) deep bowls
- Top mount sink
- SoundSecure™ sound pads
- StoneLock™ undercoating
- Two waste fittings included
- Sink clips included
- Includes (2) 9028000.075 drains
- 36" (914 mm) cabinet required

Nominal Dimensions:

21-15/16 in x 32-15/16 in x 6 in (557 mm x 836 mm x 152 mm)

Bowl Size:

14 in (wide) 16 in (front to back) 6 in (deep)



Description	Net Wt	SKU	Color	List Price
Colony® 33 x 22-Inch Stainless Steel 3-Hole Top Mount Double-Bowl ADA Kitchen Sink	11 lb 5.1 kg	22DB.6332283S.075	Stainless Steel	305

Separate Components:

Top Mount Sink Clips	0 lb 0.2 kg	▷791637-100.0070A	No Finish	13
Waste Fitting	0 lb 0.3 kg	9028000.075	Stainless Steel	33



Colony® 33 x 22-Inch Stainless Steel 4-Hole Top Mount Double Bowl ADA Kitchen Sink

- 20 gauge stainless steel
- Stamped double bowl
- 6" (152 mm) deep bowls
- Top mount sink
- SoundSecure™ sound pads
- StoneLock™ undercoating
- Two waste fittings included
- Sink clips included
- Includes (2) 9028000.075 drains
- 36" (914 mm) cabinet required

Nominal Dimensions:

32-15/16 in x 21-15/16 in x 6 in (836 mm x 557 mm x 152 mm)

Bowl Size:

14 in (wide) 16 in (front to back) 6 in (deep)



Description	Net Wt	SKU	Color	List Price
Colony® 33 x 22-Inch Stainless Steel 4-Hole Top Mount Double-Bowl ADA Kitchen Sink	11 lb 5.1 kg	22DB.6332284S.075	Stainless Steel	314

Separate Components:

Top Mount Sink Clips	0 lb 0.2 kg	▷791637-100.0070A	No Finish	13
Waste Fitting	0 lb 0.3 kg	9028000.075	Stainless Steel	33

▷ Parts Program (Non-Premier)



Colony® 15 x 15-Inch Stainless Steel 1-Hole Top Mount Single Bowl ADA Kitchen Sink

- 22 gauge stainless steel
- Stamped single bowl
- 6" (152 mm) deep bowl
- Top mount sink
- SoundSecure+™ sound pads
- StoneLock™ undercoating
- Waste fitting & sink clips included
- 18" (457 mm) cabinet required

Nominal Dimensions:

15 in x 15 in x 6 in (381 mm x 381 mm x 152 mm)

Bowl Size:

12-3/8 in (wide) 10-1/8 in (front to back) 6 in (deep)



Description	Net Wt	SKU	Color	List Price
Colony® 15 x 15-Inch Stainless Steel 1-Hole Top Mount Single-Bowl ADA Kitchen Sink	7 lb 3.4 kg	22SB.6151511S.075	Stainless Steel	200

Separate Components:

Top Mount Sink Clips	0 lb 0.2 kg	▷791637-100.0070A	No Finish	13
Waste Fitting	0 lb 0.3 kg	9028000.075	Stainless Steel	33

▷ Parts Program (Non-Premier)



Hillsdale® 33 x 22-Inch Stainless Steel Drop-In or Undermount Single-Bowl Kitchen Sink

- Single bowl sink
- Coordinating pull-down faucet, sold separately
- Installation instructions and cutout template
- Top mount installation hardware
- 20 gauge Stainless Steel
- 18-10 Chrome Nickel content
- Dual mount installation
- 36" (914 mm) cabinet required
- Limited lifetime warranty

Nominal Dimensions:

22 in x 33 in (558 mm x 838 mm)

Bowl Size:

29-9/16 in (wide) 18-9/16 in (front to back) 9 in (deep)

Description	Net Wt	SKU	Color	List Price
Hillsdale® 33 x 22-Inch Stainless Steel Drop-In or Undermount Single-Bowl Kitchen Sink	14 lb 6.5 kg	20SB.332211B.075	Stainless Steel	506
Separate Components:				
Top Mount Sink Clips	0 lb 0.2 kg	▶791637-100.0070A	No Finish	13
Optional Components:				
Waste Fitting	0 lb 0.3 kg	9028000.075	Stainless Steel	33

Kitchen and Bar Faucets

Beale® Selectronic® – Hands-Free Technology

Our hands-free, Selectronic technology is now featured on the Beale kitchen faucet. This touchless model offers the unique option of switching to manual operation by simply sliding a movable door to cover the sensor.



Hygienic

Helps reduce the risk of cross-contamination while handle and spout remain untouched.

Convenient

Easily access water when hands are full or dirty.

Long lasting

Equipped with 4 AA long-life batteries. AC adaptor available separately.



A movable door changes the faucet from touchless to manual operation in one quick movement.

This allows the user to choose when they want to use the touchless option and when they don't.

Beale Touchless Single-Handle Pull-Down Dual Spray Kitchen Faucet

Beale – MeasureFill® Technology

The Beale MeasureFill Touch kitchen faucet delivers an adjustable set volume of water, on demand, due to its unique MeasureFill technology. Simply set the measuring dial to the desired volume of water (ounces or cups) and activate the water flow via a simple touch on the dial window.



Beale MeasureFill Pull-Down Kitchen Faucet

Ease of use

Makes cooking and baking easier and more convenient.

Less clutter

Helps to reduce clutter in the kitchen by eliminating the need for additional tools.

Touch or manual faucet activation

Activation of regular water flow through a simple touch on the faucet dial or manually via the faucet lever.



MeasureFill Detail

Kitchen and Bar Faucets

SelectFlo® Multi-Function Spray Technology

With geometric styling and impressive functionality, Edgewater® pull-down kitchen faucets feature an intuitive multi-function sprayer that allows the user to efficiently manage common kitchen tasks. The five-function SelectFlo® spray head includes a stream, spray, jet, mist and pause function. Optional scrub brushes are available to attach directly to the spray head with a simple twist for added cleaning convenience.

Increased functionality

- Four spray functions and pause
- Toggle down into spray mode
- Rotate dial to select spray
- Water will always turn on in STREAM mode

Luxury look and feel

Optional brush attachment

- Connects directly to spray head
- Assists with tough cleaning tasks



Edgewater® SelectFlo Pull-Down Kitchen Faucet



Edgewater Semi-Professional Kitchen Faucet

Kitchen and Bar Faucets

Select a Spray



Kitchen and Bar Faucets

























Traditional, contemporary or transitional, there's an American Standard faucet to complement every kitchen. Combining superior functionality and design, each is equipped with ceramic disc valves for drip-free performance and is available in beautiful scratch- and tarnish-resistant finishes.

Kitchen and Bar Faucets



Kitchen and Bar Faucets

Kitchen and Bar Faucets Overview

Pull-Down Kitchen Faucets			Pull-Out Kitchen Faucets		
					
Touchless Kitchen Faucets			Beale® MeasureFill™		
					
Single-Handle Kitchen Faucets			2-Handle Kitchen Faucets		
					
Single-Handle Bar Faucets			2-Handle Bar Faucets		
					
Semi-Pro	Pot Filler	Laundry	Accessories		
					

Kitchen and Bar Faucets

Kitchen Faucets

Pull-Down Faucets

Pull-Down Kitchen Faucets

	Description	ADA CEC	SKU #	Color/Finish	List Price
	<p>Beale® Single-Handle Pull-Down Dual Spray Kitchen Faucet 1.5 gpm/5.7 L/min</p> <ul style="list-style-type: none"> • Features Re-Trax® spray head retraction system • Standard manual operation • 2-function spray • Spout height: 17-9/16" (446 mm) • Spout clearances: 10-1/2" (267 mm) • Washerless (35 mm) ceramic disc valve cartridge • 1.5 gpm/5.7 L/min maximum flow • Metal body, handle and mounting hardware • Brass swivel spout 		4931300.002	Polished Chrome	496
			4931300.075	Stainless Steel	590
	<p>Colony® PRO Single-Handle Pull-Down Dual Spray Kitchen Faucet 1.5 gpm/5.7 L/min</p> <ul style="list-style-type: none"> • Ceramic disc valve cartridge (28 mm) • 1.5 gpm/5.7 L/min maximum flow • Metal deck plate and metal lever handle • Pull-down spray with adjustable spray pattern: pause, spray, aerator • Integrated 35" braided stainless steel supply lines • Metal swivel spout • Spout height: 16-9/20" (417 mm) 		7077300.002	Polished Chrome	341
			7077300.075	Stainless Steel	410
			7077300.243	Matte Black	472
	<p>Delancey® Single-Handle Pull-Down Dual Spray Function Kitchen Faucet 1.5 gpm/5.7 L/min</p> <ul style="list-style-type: none"> • Washerless ceramic disc valve cartridge • 1.5 gpm/5.7 L/min maximum flow • Brass body and swivel spout • Metal lever handle • 28-3/4" (730 mm) long braided flexible supply hoses with 3/8" (10 mm) compression connectors • Spout height: 16-11/16" (424 mm) • Spout clearance: 9-5/16" (237 mm) • Features Re-Trax® spray head retraction system 		4279300.002	Polished Chrome	527
			4279300.013	Polished Nickel	633
			4279300.075	Stainless Steel	633
			4279300.278	Legacy Bronze	682
	<p>Edgewater® Single-Handle Pull-Down Multi Spray Kitchen Faucet 1.8 gpm/6.8 L/min</p> <ul style="list-style-type: none"> • SelectFlo® spray head: 4-function spray with pause offers stream, spray, mist and jet sprays to perform various kitchen tasks • Ceramic disc valve cartridge assures smooth, precise valve control and a lifetime of drip-free, maintenance-free performance • Metal body and handle • 1.5 gpm/5.7 L/min maximum flow • Features Re-Trax® retraction system • Brass swivel spout • Spout height: 17-7/16" (443 mm) • Spout clearance: 9" (228 mm) 		4932300.002	Polished Chrome	533
			4932300.075	Stainless Steel	682



Kitchen Faucets

Pull-Down Faucets

	Description	SKU #	Color/Finish	List Price	
	Hillsdale™ Single-Handle Pull-Down Dual Spray Kitchen Faucet <ul style="list-style-type: none"> • Ceramic disc valve cartridge (35 mm) • 1.8 gpm/6.8 L/min maximum flow • Metal swivel spout • Metal lever handle • Includes optional deck plate • Pull-down spray with adjustable spray pattern • Integrated braided stainless steel supply lines 	 7617300.002	Polished Chrome	300	
		 7617300.075	Stainless Steel	360	
		7617300.243	Matte Black	390	
	Renate™ Single-Handle Pull-Down Single Spray Kitchen Faucet 1.5 gpm/5.7 Lpm <ul style="list-style-type: none"> • Washerless ceramic disc valve cartridge • 1.5 gpm/5.7 L/min maximum flow • Brass body and swivel spout • Metal lever handle • 28-¾" (730 mm) long braided flexible supply hoses with 3/8" (10 mm) compression connectors • Spout height: 16-11/16" (424 mm) • Spout clearance: 9-5/16" (237 mm) • Features Re-Trax® spray head retraction system 	 9319310.002	Polished Chrome	361	
		 9319310.075	Stainless Steel	458	
		9319310.243	Matte Black	470	
	Saybrook® Single-Handle Pull-Down Dual Spray Kitchen Faucet 1.5 gpm/5.7 L/min With Filter <ul style="list-style-type: none"> • Quick and easy filter replacement from countertop • Reduces chlorine, lead and particles while improving taste & odor • Instant cold filtered water with a press of a button • Separate cold waterway means immediate filtered H2O that never mixes with unfiltered water • Can be installed at countertop level or inside cabinet • 300 gallon filter life • Filter indicators take out the guesswork and identify the following: Low Filter, Very Low Filter, Replace Filter, Replace Batteries • Dual spray function for ease of cleaning • Re-Trax feature ensures smooth retraction of spray head after use • Limited Lifetime Guarantee 	 4902330.002	Polished Chrome	672	
		 4902330.075	Stainless Steel	719	
					
	Studio® S Pull-Down Dual Spray Kitchen Faucet 1.5 gpm/5.7 L/min <ul style="list-style-type: none"> • High 18" (457 mm) design makes it easy to fill large pots and lends a professional look • Wipe-clean, one-piece lever handle eliminates tiny crevices where build-up hides • Dual-function 1.5GPM spray head with pause easily toggles from a powerful spray to a smooth stream with one hand • Re-Trax® feature ensures smooth retraction of spray head after use • Swivel spout rotates 360° for optimal reach and range of motion in and around the sink • Rubber spray nozzles wipe clean easily with your fingertip • Drip-free performance with high quality ceramic disc valve • Durable metal construction • Pre-installed braided nylon supply lines • Limited lifetime warranty 	 4803300.002	Polished Chrome	434	
		 4803300.075	Stainless Steel	546	
		4803300.243	Matte Black	563	
					

Pull-Down Kitchen Faucets

Kitchen Faucets

Pull-Out Faucets



Description

Colony® PRO Single-Handle Pull-Out Dual Spray Kitchen Faucet 1.5 gpm/5.7 L/min

- Ceramic disc valve cartridge (40 mm)
- 1.5 gpm/5.7 L/min maximum flow
- Brass swivel spout
- Metal deck plate and metal lever handle
- Pull-out spray with adjustable spray pattern
- Spout height: 7-3/4" (197 mm)
- Spout reach: 8-5/8" (220 mm)
- Spout clearance: 5-1/2" (139 mm)
- Integrated braided stainless steel supply lines



SKU #

7074100.002
7074100.075

Color/Finish

Polished Chrome
Stainless Steel

List Price

279
335



Studio® S Pull-Out Dual Spray Kitchen Faucet

- Dual-function spray head offers stream and forceful sprays for optimal rinsing
- Profile is designed to accommodate many kitchen configurations
- Wipe-clean, one-piece lever handle eliminates tiny crevices where build-up hides
- Swivel spout for added functionality and convenience rotates 120°
- Rubber spray nozzles wipe clean easily with your fingertip
- Drip-free performance with high quality ceramic disc valve
- Durable brass and metal construction
- Pre-installed braided nylon supply lines
- Limited lifetime warranty



4803100.002
4803100.075
4803100.243

Polished Chrome
Stainless Steel
Matte Black





360
445
461





Pull-Out Kitchen Faucets

Kitchen Faucets





Touchless Faucets

Description	SKU #	Color/Finish	List Price
 <p>Beale® Touchless Single-Handle Pull-Down Dual Spray Kitchen Faucet 1.5 gpm/5.7 L/min</p> <ul style="list-style-type: none"> • Selectronic® Touchless operation turns water flow on and off with a wave of the hand • Place faucet into manual mode by closing the sliding door • 2-function spray • Features Re-Trax® spray head retraction system • Comes with 4 AA long-life batteries. AC adaptor available separately • Washerless (35 mm) ceramic disc valve cartridge • 1.5 gpm/5.7 L/min maximum flow • Metal body, handle and mounting hardware • Brass swivel spout • Spout height: 17-9/16" (446 mm) • Spout clearance: 10-1/2" (267 mm) 	 4931380.002  4931380.075	Polished Chrome Stainless Steel	712 868
	 		

 <p>Colony® PRO Touchless Single-Handle Pull-Down Dual Spray Kitchen Faucet 1.5 gpm/5.7 L/min</p> <ul style="list-style-type: none"> • Selectronic® Hands-Free Technology featuring a front facing wave on/off IR sensor • Ceramic disc valve cartridge (28 mm) • 1.5 gpm/5.7 L/min maximum flow • Includes deck plate • Pull-down spray with adjustable spray pattern: Pause, spray, aerator • Integrated 35" braided stainless steel supply lines • Metal swivel spout and lever handle • Spout height: 16-9/20" (417 mm) • Powered by 4 AA batteries which are included 	 7077380.002  7077380.075 7077380.243	Polished Chrome Stainless Steel Matte Black	512 615 708
--	---	---	-------------------

Touchless / MeasureFill





MeasureFill Faucets

 <p>Beale MeasureFill™ 2-Handle Pull-Down Dual Spray Kitchen Faucet 1.5 gpm/5.7 L/min With MeasureFill™ Dial</p> <ul style="list-style-type: none"> • Set MeasureFill™ dial to desired volume of water and touch to dispense • Spout height: 17 - 5/8" (448 mm); Spout clearance: 9 - 5/8" (244 mm) • Use faucet manually via faucet lever • Features Re-Trax® spray head retraction system • 2-function spray with pause button • Comes with 4 AA long-life batteries. AC adaptor available separately • Washerless (35 mm) ceramic disc valve cartridge • 1.5 gpm/5.7 L/min maximum flow • Metal body, handle and mounting hardware • Brass swivel spout 	 4931360.002  4931360.075	Polished Chrome Stainless Steel	744 930
	 		

Kitchen Faucets

Single-Handle Faucets

Single-Handle Kitchen Faucets

	Description	SKU #	Color/Finish	List Price
	<p>Colony® PRO Single-Handle Kitchen Faucet 1.5 gpm/5.7 L/min</p> <ul style="list-style-type: none"> • Ceramic disc valve cartridge (35 mm) • 1.5 gpm/5.7 L/min maximum flow • Brass swivel spout • Metal deck plate and metal lever handle • Spout height: 5-7/8" (150 mm) • Spout reach: 8-1/2" (216 mm) • Spout clearance: 4-7/8" (125 mm) • Integrated braided stainless steel supply lines 	7074000.002	Polished Chrome	155
		7074000.075	Stainless Steel	186
	<p>Colony® PRO Single-Handle Kitchen Faucet 1.5 gpm/5.7 L/min</p> <ul style="list-style-type: none"> • Ceramic disc valve cartridge (35 mm) • 1.5 gpm/5.7 L/min maximum flow • Brass swivel spout • Metal lever handle • Spout height: 5-7/8" (150 mm) • Spout reach: 8-1/2" (216 mm) • Spout clearance: 4-7/8" (125 mm) • Integrated braided stainless steel supply lines 	7074010.002	Polished Chrome	155
		7074010.075	Stainless Steel	186
	<p>Colony® PRO Single-Handle Kitchen Faucet 1.5 gpm/5.7 L/min With Side Spray</p> <ul style="list-style-type: none"> • Ceramic disc valve cartridge (35 mm) • 1.5 gpm/5.7 L/min maximum flow • Brass swivel spout • Metal deck plate and metal lever handle • With side spray through deck plate • Spout height: 5-7/8" (150 mm) • Spout reach: 8-1/2" (216 mm) • Spout clearance: 4-7/8" (125 mm) • Integrated braided stainless steel supply lines 	7074030.002	Polished Chrome	186
		7074030.075	Stainless Steel	223
	<p>Colony® PRO Single-Handle Kitchen Faucet 1.5 gpm/5.7 L/min With Side Spray</p> <ul style="list-style-type: none"> • Ceramic disc valve cartridge (35 mm) • 1.5 gpm/5.7 L/min maximum flow • Brass swivel spout • Metal deck plate and metal lever handle • With side spray • Spout height: 5-7/8" (150 mm) • Spout reach: 8-1/2" (216 mm) • Spout clearance: 4-7/8" (125 mm) • Integrated braided stainless steel supply lines 	7074040.002	Polished Chrome	186
		7074040.075	Stainless Steel	223

Kitchen Faucets

2-Handle Faucets

	Description	ADA CEC	SKU #	Color/Finish	List Price
	<p>Colony® PRO 2-Handle Kitchen Faucet 1.5 gpm/5.7 L/min</p> <ul style="list-style-type: none"> • Ceramic disc valve cartridges • 1.5 gpm/5.7 L/min maximum flow • Brass swivel spout • Metal deck plate and metal lever handles • Low arc spout • Spout height: 6" (153 mm) • Spout reach: 8-½" (216 mm) • Spout clearance: 5" (128 mm) 		7074500.002	Polished Chrome	149
	<p>Colony® PRO 2-Handle Kitchen Faucet 1.5 gpm/5.7 L/min Without Side Spray</p> <ul style="list-style-type: none"> • Ceramic disc valve cartridges • 1.5 gpm/5.7 L/min maximum flow • Brass swivel spout • Metal deck plate and metal lever handles • High arc spout • LESS side spray • Spout height: 12-½" (318 mm) • Spout reach: 7-5/8" (195 mm) • Spout clearance: 7-¼" (183 mm) 		7074550.002	Polished Chrome	179
	<p>Colony® PRO 2-Handle Kitchen Faucet 1.5 gpm/5.7 L/min With Side Spray</p> <ul style="list-style-type: none"> • Ceramic disc valve cartridges • 1.5 gpm/5.7 L/min maximum flow • Brass swivel spout • Metal deck plate and metal lever handles • Low arc spout • With side spray • Spout height: 6" (153 mm) • Spout reach: 8-½" (216 mm) • Spout clearance: 5" (128 mm) 		7074501.002	Polished Chrome	179
	<p>Colony® PRO 2-Handle Kitchen Faucet 1.5 gpm/5.7 L/min With Side Spray</p> <ul style="list-style-type: none"> • Ceramic disc valve cartridges • 1.5 gpm/5.7 L/min maximum flow • Brass swivel spout • Metal deck plate and metal lever handles • High arc spout • With side spray • Spout height: 12-½" (318 mm) • Spout reach: 7-5/8" (195 mm) • Spout clearance: 7-¼" (183 mm) 		7074551.002	Polished Chrome	211
	<p>Delancey® 2-Handle Widespread Kitchen Faucet 1.5 gpm/5.7 L/min With Side Spray</p> <ul style="list-style-type: none"> • Washerless ceramic disc valve cartridge • 1.5 gpm/5.7 L/min maximum flow • Brass body and swivel spout • Metal lever handles • 28-¾" (730 mm) long braided flexible supply hoses with 3/8" (10 mm) compression connectors • Color-matched side spray • Spout height: 13-15/16" (353 mm) • Spout clearance: 8-7/16" (214 mm) 		4279701.002 4279701.013 4279701.075 4279701.278	Polished Chrome Polished Nickel Stainless Steel Legacy Bronze	404 483 483 527









2-Handle Kitchen Faucets



Bar Faucets







Single-Handle Bar Faucets

Single-Handle Bar Faucets

	Description	ADA CEC	SKU #	Color/Finish	List Price
	Delancey® Single-Handle Pull-Down Bar Faucet 1.5 gpm/5.7 L/min <ul style="list-style-type: none"> • Washerless ceramic disc valve cartridge • 1.5 gpm/5.7 L/min maximum flow • Brass body and swivel spout • Metal lever handle • 28-3/4" (730 mm) long braided flexible supply hoses with 3/8" (10 mm) compression connectors • Pull-down spray • Spout height: 15-1/8" (383 mm) • Spout clearance: 10-3/8" (263 mm) • Features Re-Trax® spray head retraction system 		4279410.002	Polished Chrome	434
			4279410.013	Polished Nickel	522
			4279410.075	Stainless Steel	522
			4279410.278	Legacy Bronze	559
					
	Edgewater® Single-Handle Pull-Down Single Spray Bar Faucet 1.5 gpm/5.7 L/min <ul style="list-style-type: none"> • Single function pull-down spray head • Ceramic disc valve cartridge assures smooth, precise valve control and a lifetime of drip-free, maintenance-free performance • Metal body and handle • 1.5 gpm/5.7 L/min maximum flow • Features Re-Trax® retraction system • Brass swivel spout • Spout height: 14-7/16" (336 mm) • Spout clearance: 7-5/16" (201 mm) 		4932410.002	Polished Chrome	464
					
	Studio® S Pull-Down Bar Faucet 1.5 gpm/5.7 L/min <ul style="list-style-type: none"> • Contemporary profile is the perfect height for prep sinks and smaller kitchens • Wipe-clean, one-piece lever handle eliminates tiny crevices where build-up hides • Re-Trax® feature ensures smooth retraction of spray head after use • Swivel spout rotates 360° for optimal reach and range of motion in and around the sink • Rubber spray nozzles wipe clean easily with your fingertip • Drip-free performance with high quality ceramic disc valve • Durable brass and metal construction • Pre-installed braided nylon supply lines • Limited lifetime warranty 		4803410.002	Polished Chrome	394
			4803410.075	Stainless Steel	507
			4803410.243	Matte Black	540
					

Bar Faucets

2-Handle Bar Faucets



	Description	SKU #	Color/Finish	List Price	
	Colony® PRO 2-Handle Bar Faucet 1.5 gpm/5.7 L/min <ul style="list-style-type: none"> • Ceramic disc valve cartridges • 1.5 gpm/5.7 L/min maximum flow • Brass swivel spout • Metal deck plate and metal lever handles • Aerator end • Low arc spout • Spout height: 6-7/8" (174 mm) • Spout reach: 6-1/4" (159 mm) • Spout clearance: 4-5/8" (117 mm) 		7074140.002	Polished Chrome	125
			7074400.002	Polished Chrome	125
	Colony® PRO 2-Handle Bar Faucet 1.5 gpm/5.7 L/min <ul style="list-style-type: none"> • Ceramic disc valve cartridges • 1.5 gpm/5.7 L/min maximum flow • Brass swivel spout • Metal deck plate and metal lever handles • High arc spout • Spout height: 10-7/8" (275 mm) • Spout reach: 5-3/4" (146 mm) • Spout clearance: 7-3/8" (186 mm) 		7074400.075	Stainless Steel	149
	Delancey® 2-Handle Bar Faucet 1.5 gpm/5.7 L/min <ul style="list-style-type: none"> • Washerless ceramic disc valve cartridge • 1.5 gpm/5.7 L/min maximum flow • Brass body and swivel spout • Metal lever handles • 28-3/4" (730 mm) long braided flexible supply hoses with 3/8" (10 mm) compression connectors • Spout height: 12-5/8" (321 mm) • Spout clearance: 6-1/16" (153 mm) 		4279400.002	Polished Chrome	311
			4279400.013	Polished Nickel	373
			4279400.075	Stainless Steel	373
			4279400.278	Legacy Bronze	404



2-Handle Bar Faucets

Kitchen Faucets

Semi-Professional

	Description	SKU #	Color/Finish	List Price
	Edgewater® Single-Handle Semi-Pro Multi Spray Kitchen Faucet 1.8 gpm/6.8 L/min	4932350.002	Polished Chrome	682
	<ul style="list-style-type: none"> • SelectFlo® spray head: 4-function spray with pause offers stream, spray, mist and jet sprays to perform various kitchen tasks • Ceramic disc valve cartridge assures smooth, precise valve control and a lifetime of drip-free, maintenance-free performance • Metal body and handle • 1.5 gpm/5.7 L/min maximum flow • Features Re-Trax® retraction system • Swivel spout • Spout height: 19" (482 mm) • Spout clearance: 8-11/16" (220 mm) 	4932350.075	Stainless Steel	836
	Grayson™ Semi-Professional Single-Handle Kitchen Faucet	7612350.075	Stainless Steel	475
	<ul style="list-style-type: none"> • Flexible stainless steel coil spring for full reach and wipe-clean care • Dual-function spray head offers stream and forceful spray for rinsing • Easy-clean, one-piece lever handle eliminates tiny crevices where build-up hides • Swivel spout rotates 360° for optimal reach and range of motion in and around the sink • Drip-free performance with high quality ceramic disc valve • 1.8 gpm/6.8 L/min maximum flow • Pre-installed braided nylon supply lines • Includes color-matched soap dispenser • Includes optional deckplate • Limited lifetime warranty 	7612350.243	Matte Black	570
	Studio® S Semi-Pro Pull-Down Dual Spray Kitchen Faucet With Spring Spout	4803350.002	Polished Chrome	577
	<ul style="list-style-type: none"> • Flexible stainless steel coil spring for full reach and wipe-clean care • Dual-function spray head offers stream and forceful spray for rinsing • Easy-clean, one-piece lever handle eliminates tiny crevices where build-up hides • Swivel spout rotates 360° for optimal reach and range of motion in and around the sink • Rubber spray nozzles wipe clean easily with your fingertip • Drip-free performance with high quality ceramic disc valve • Durable brass and metal construction • Pre-installed braided nylon supply lines • Limited lifetime warranty 	4803350.075	Stainless Steel	691
		4803350.243	Matte Black	732

Kitchen Faucets

Pot Filler Kitchen Faucet



Description

Studio® S Wall-Mount Pot Filler Kitchen Faucet

- Extends 22" (559 mm) to easily reach pots and pans on front or back burners
- Drip-free performance with high quality ceramic disc valve
- Designed for cold water attachment
- Durable brass and metal construction
- 4.0 gallons per minute (15.1 L/min) flow rate at 60 psi
- Limited lifetime warranty



SKU #

- 4803900.002
- 4803900.075
- 4803900.243

Color/Finish

- Polished Chrome
- Stainless Steel
- Matte Black

List Price

- 650
- 799
- 899



Laundry Faucets

2-Handle Laundry Faucet



Colony® PRO 2-Handle Laundry Faucet 1.5 gpm/5.7 L/min

- Ceramic disc valve cartridges
- 1.5 gpm/5.7 L/min maximum flow
- Brass swivel spout
- Metal deck plate and metal lever handles
- Hose end
- Low arc spout
- Unrestricted flow
- Spout height: 6-7/8" (174 mm)
- Spout reach: 6-1/4" (159 mm)
- Spout clearance: 4-5/8" (117 mm)



SKU #

7074240.002

Color/Finish

Polished Chrome







List Price

125

Pot Filler Kitchen Faucet

Kitchen and Bar Faucets

Accessories

	Description	SKU #	Color/Finish	List Price
	Beale® Deck Plate <ul style="list-style-type: none"> • Metal construction • Available for use with Beale® models 4931380, 4931300 and 4931410 • Includes putty plate 	9431888.002	Polished Chrome	38
		9431888.075	Stainless Steel	46
	Deck Plate <ul style="list-style-type: none"> • For use with a variety of American Standard kitchen faucets • Metal construction • Includes putty plate 	4902882.002	Polished Chrome	39
		4902882.075	Stainless Steel	39
	Kitchen Faucet Deck Plate <ul style="list-style-type: none"> • For use with a variety of American Standard kitchen faucets • Metal construction • Includes putty plate 	1660152.002	Polished Chrome	39
		1660152.013	Polished Nickel	47
		1660152.075	Stainless Steel	47
		1660152.243	Matte Black	47
		1660152.278	Legacy Bronze	50
	SelectFlo® Scrub Brush – Set of 2 <ul style="list-style-type: none"> • Snaps onto faceplate of SelectFlo kitchen faucets • Soft, gray bristles for gentle scrubbing • Firmer, blue bristles for tough scrubbing 	1660403.007	No Finish	18
	Liquid Soap Dispenser <ul style="list-style-type: none"> • Top-fill design • Dispenses liquid soap or lotion • Solid brass spout and escutcheon • Accommodates up to 2-3/8" (60 mm) thick countertop 	4503120.002	Polished Chrome	112
		4503120.013	Polished Nickel	137
		4503120.075	Stainless Steel	137
		4503120.243	Matte Black	139
		4503120.278	Legacy Bronze	149
	Plug-In AC Power Supply with 6' (183 cm) Cord <ul style="list-style-type: none"> • Class 2 UL certified • Operates at 100 - 240 VAC, 50/60 Hz • IP65 water-tight connector • One power supply can run up to 15 Selectronic products at one time • Can be used with all Selectronic Base Model Faucets and Flush Valves 	M950338-0070A	No Finish	72

	Description	SKU #	Color/Finish	List Price
	<p>Extension Kit</p> <ul style="list-style-type: none"> • Extends shank 2-1/4" (57 mm) • For use on 4" centersets with 1/2" (13 mm) male inlet shanks • For use on top mount kitchens with 1/2" (13 mm) male inlet shanks • For use on 4" center-set faucets with 1/2" male inlet shanks and top mount faucets with 1/2" (13 mm) male inlet shanks • Includes 2 extensions 	M960131-0070A	No Finish	42

	<p>Replacement Cartridge for Saybrook Kitchen Faucet</p> <ul style="list-style-type: none"> • For use with American Standard Saybrook Filtered Kitchen Faucet • Lasts 6 months for a family of 4 with typical usage • Filters 300 gallons of water with a single filter • INDEPENDENTLY CERTIFIED TO REDUCE: 99.7% of lead from tap water*, 96.9% of chlorine from tap water**, 92.6% of particulate contamination (Class 1) from tap water** 	F50	No Finish	87
---	--	-----	-----------	----

Safer and Accessible Living

Remodeling a bathroom so you or someone in your family can remain at home? Or is a parent moving in? Or has a new baby arrived? American Standard offers a wide-ranging collection of products designed to provide style, safety and comfort over a lifetime. We've got more than a few patented ideas you won't see elsewhere. Check out our exclusive safer and accessible products.



Chair Height Toilets

16-1/2" (419 mm) rim height allows for easier and more comfortable use.



Storage

Accessible and functional storage, keeps items out of the way and area free from hazards.



Safe and Easy Faucets

ADA-approved lever faucets allow easy operation without the need to grip.



Safer and Accessible

Independent, Safer and Comfortable Bathing

American Standard, an industry leader and original manufacturer of acrylic Walk-in baths, makes it easy to enter and exit the bath giving the user the freedom to enjoy a luxurious bathing experience in privacy, safety and comfort.

With thoughtful standard features, a variety of sizes and options and high quality craftsmanship, all of our Walk-in baths are expertly designed to provide accessible and comfortable bathing experiences.

Exclusive Innovations

Patented Quick Drain®

- Fast water removal system
- Ties directly into the standard drain system
- No additional plumbing required

Watertight Door System Technology

- Ergonomic, easy to use handle
- Lifetime warranty on seal



Fast draining
less waiting



Lifetime of
trouble-free use



Quality and innovation built into every bath

- | | |
|--|--|
| 1 Patented Door System Technology with a lifetime warranty on the door's watertight seal | 5 Tub extender for easy retrofit into standard tub space |
| 2 17" (432 mm) chair height seat | 6 Plumbing and fixture access panels |
| 3 Freestanding metal support frame – self leveling feet | 7 Textured tub floor |
| 4 Built-in grab bar | 8 Low threshold |

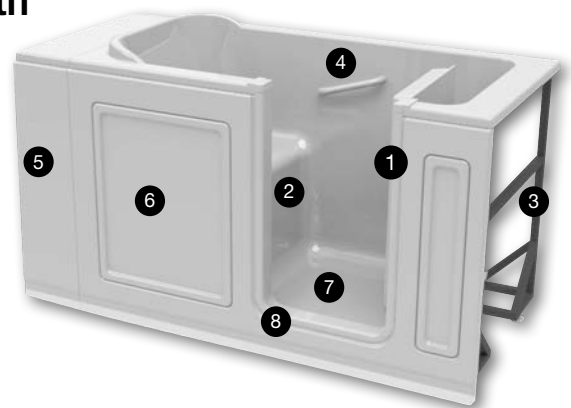

Walk-in bath hydrotherapy options

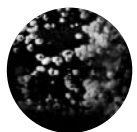

Soaker Bath
Provides a warm relaxing soak



Whirlpool Massage System
Invigorating water jets target key areas

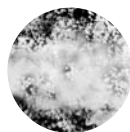

Air Spa System
Soothing cascade of warm air bubbles

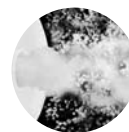

Combination System
Combines all of the features of the Soaker Tub, the Whirlpool Massage and the Air Spa System for the ultimate therapeutic bathing experience



- Premium cast acrylic construction
- Patented Quick Drain® fast water removal system
- Warranty: lifetime on the door seal, 15-years on the tub shell, 10-years on components
- Patented watertight door system
- Built-in 17" (432 mm) chair height seat
- Built-in color-matched grab bar
- Textured tub floor
- Color-matched waste and overflow
- Freestanding metal support frame
- In-line water heater*
- Neck pillow
- Chromatherapy multi-colored light system†
- 13 Water jets*
- 26 Air jets‡
- Ozone sanitation*
- Legs-only massage setting*
- Premium faucet with handheld shower in polished chrome included

Nominal Dimensions:

59-3/4 in x 32 in x 37-1/2 in (1517 mm x 812 mm x 952 mm)

Hand Drain With Faucet

Description	Net Wt	SKU	Color	List Price
Acrylic Luxury Series 32 x 60 -Inch Walk-in Tub With Soaker System - Left-Hand Drain With Faucet	138 lb 62.7 kg	3260.219.SLL	Linen	10,865
		3260.219.SLW	White	10,865
Acrylic Luxury Series 32 x 60 -Inch Walk-in Tub With Soaker System - Right-Hand Drain With Faucet		3260.219.SRL	Linen	10,865
		3260.219.SRW	White	10,865
Acrylic Luxury Series 32 x 60 -Inch Walk-in Tub With Whirlpool System - Left-Hand Drain With Faucet	162 lb 73.5 kg	3260.219.WLL	Linen	12,944
		3260.219.WLW	White	12,944
Acrylic Luxury Series 32 x 60 -Inch Walk-in Tub With Whirlpool System - Right-Hand Drain With Faucet		3260.219.WRL	Linen	12,944
		3260.219.WRW	White	12,944
Acrylic Luxury Series 32 x 60 -Inch Walk-in Tub With Air Spa System - Left-Hand Drain With Faucet	154 lb 69.9 kg	3260.219.ALL	Linen	13,498
		3260.219.ALW	White	13,498
Acrylic Luxury Series 32 x 60 -Inch Walk-in Tub With Air Spa System - Right-Hand Drain With Faucet		3260.219.ARL	Linen	13,498
		3260.219.ARW	White	13,498
Acrylic Luxury Series 32 x 60 -Inch Walk-in Tub With Combination Air Spa and Whirlpool Systems - Left-Hand Drain With Faucet	178 lb 80.8 kg	3260.219.CLL	Linen	14,497
		3260.219.CLW	White	14,497
Acrylic Luxury Series 32 x 60 -Inch Walk-in Tub With Combination Air Spa and Whirlpool Systems - Right-Hand Drain With Faucet		3260.219.CRL	Linen	14,497
		3260.219.CRW	White	14,497

NOTE: American Standard Walk-in Baths cannot be combined with any other American Standard product orders and are not eligible for any rebates or other discount programs. For more information or to place orders please call: 1-866-423-0800 or fax: 888-872-3044

*Only available on Whirlpool and Combination Systems †Only available on Combination Systems

‡Only available on Air Spa and Combination Systems



- Premium cast acrylic construction
- Patented Quick Drain® fast water removal system
- Warranty: lifetime on the door seal, 15-years on the tub shell, 10-years on components
- Patented watertight door system
- Built-in 17" (432 mm) chair height seat
- Built-in color-matched grab bar
- Textured tub floor
- Color-matched waste and overflow
- Freestanding metal support frame
- In-line water heater*
- Neck pillow
- Chromatherapy multi-colored light system†
- 13 Water jets*
- 26 Air jets‡
- Ozone sanitation*
- Legs-only massage setting*

Nominal Dimensions:

59-3/4 in x 32 in x 37-1/2 in (1517 mm x 812 mm x 952 mm)

Description	Net Wt	SKU	Color	List Price
Acrylic Luxury Series 32 x 60 -Inch Walk-in Tub With Soaker System - Left-Hand Drain	224 lb 101.7 kg	3260.215.SLL	Linen	10,346
		3260.215.SLW	White	10,346
Acrylic Luxury Series 32 x 60 -Inch Walk-in Tub With Soaker System - Right-Hand Drain		3260.215.SRL	Linen	10,346
		3260.215.SRW	White	10,346
Acrylic Luxury Series 32 x 60 -Inch Walk-in Tub With Whirlpool System - Left-Hand Drain	248 lb 112.6 kg	3260.215.WLL	Linen	12,426
		3260.215.WLW	White	12,426
Acrylic Luxury Series 32 x 60 -Inch Walk-in Tub With Whirlpool System - Right-Hand Drain		3260.215.WRL	Linen	12,426
		3260.215.WRW	White	12,426
Acrylic Luxury Series 32 x 60 -Inch Walk-in Tub With Air Spa System - Left-Hand Drain	240 lb 109.0 kg	3260.215.ALL	Linen	12,980
		3260.215.ALW	White	12,980
Acrylic Luxury Series 32 x 60 -Inch Walk-in Tub With Air Spa System - Right-Hand Drain		3260.215.ARL	Linen	12,980
		3260.215.ARW	White	12,980
Acrylic Luxury Series 32 x 60 -Inch Walk-in Tub With Combination Air Spa and Whirlpool Systems - Left-Hand Drain	264 lb 119.9 kg	3260.215.CLL	Linen	13,978
		3260.215.CLW	White	13,978
Acrylic Luxury Series 32 x 60 -Inch Walk-in Tub With Combination Air Spa and Whirlpool Systems - Right-Hand Drain With Faucet		3260.215.CRL	Linen	13,978
		3260.215.CRW	White	13,978

Walk-In-Baths

NOTE: American Standard Walk-in Baths cannot be combined with any other American Standard product orders and are not eligible for any rebates or other discount programs. For more information or to place orders please call: 1-866-423-0800 or fax: 888-872-3044

*Only available on Whirlpool and Combination Systems †Only available on Combination Systems

‡Only available on Air Spa and Combination Systems



- Premium cast acrylic construction
- Patented Quick Drain® fast water removal system
- Warranty: lifetime on the door seal, 15-years on the tub shell, 10-years on components
- Patented watertight door system
- Built-in 17" (432 mm) chair height seat
- Built-in color-matched grab bar
- Textured tub floor
- Color-matched waste and overflow
- Freestanding metal support frame
- In-line water heater*
- Neck pillow
- Chromatherapy multi-colored light system†
- 13 Water jets*
- 26 Air jets‡
- Ozone sanitation*
- Legs-only massage setting*
- Extension kit to fit 60" (1524 mm) space
- Premium faucet with multi-function handheld shower in Polished Chrome included

Nominal Dimensions:

50-1/2 in x 30 in x 37-1/2 in (1282 mm x 762 mm x 952 mm)

Description	Net Wt	SKU	Color	List Price
Acrylic Luxury Series 30 x 51 -Inch Walk-in Tub With Soaker System - Left-Hand Drain With Faucet	186 lb 84.4 kg	3051.119.SLL	Linen	9,755
		3051.119.SLW	White	9,755
Acrylic Luxury Series 30 x 51 -Inch Walk-in Tub With Soaker System - Right-Hand Drain With Faucet		3051.119.SRL	Linen	9,755
		3051.119.SRW	White	9,755
Acrylic Luxury Series 30 x 51 -Inch Walk-in Tub With Whirlpool System - Left-Hand Drain With Faucet	210 lb 95.3 kg	3051.119.WLL	Linen	11,974
		3051.119.WLW	White	11,974
Acrylic Luxury Series 30 x 51 -Inch Walk-in Tub With Whirlpool System - Right-Hand Drain With Faucet		3051.119.WRL	Linen	11,974
		3051.119.WRW	White	11,974
Acrylic Luxury Series 30 x 51 -Inch Walk-in Tub With Air Spa System - Left-Hand Drain With Faucet	202 lb 91.7 kg	3051.119.ALL	Linen	12,527
		3051.119.ALW	White	12,527
Acrylic Luxury Series 30 x 51 -Inch Walk-in Tub With Air Spa System - Right-Hand Drain With Faucet		3051.119.ARL	Linen	12,527
		3051.119.ARW	White	12,527
Acrylic Luxury Series 30 x 51 -Inch Walk-in Tub With Combination Air Spa and Whirlpool Systems - Left-Hand Drain With Faucet	226 lb 102.6 kg	3051.119.CLL	Linen	13,526
		3051.119.CLW	White	13,526
Acrylic Luxury Series 30 x 51 -Inch Walk-in Tub With Combination Air Spa and Whirlpool Systems - Right-Hand Drain With Faucet		3051.119.CRL	Linen	13,526
		3051.119.CRW	White	13,526

NOTE: American Standard Walk-in Baths cannot be combined with any other American Standard product orders and are not eligible for any rebates or other discount programs. For more information or to place orders please call: 1-866-423-0800 or fax: 888-872-3044

*Only available on Whirlpool and Combination Systems †Only available on Combination Systems

‡Only available on Air Spa and Combination Systems



- Premium cast acrylic construction
- Patented Quick Drain® fast water removal system
- Warranty: lifetime on the door seal, 15-years on the tub shell, 10-years on components
- Patented watertight door system
- Built-in 17" (432 mm) chair height seat
- Built-in color-matched grab bar
- Textured tub floor
- Color-matched waste and overflow
- Freestanding metal support frame
- In-line water heater*
- Neck pillow
- Chromatherapy multi-colored light system†
- 13 Water jets*
- 26 Air jets‡
- Ozone sanitation*
- Legs-only massage setting*
- Extension kit to fit 60" (1524 mm) space

Nominal Dimensions:

50-1/2 in x 30 in x 37-1/2 in (1282 mm x 762 mm x 952 mm)

Description	Net Wt	SKU	Color	List Price
Acrylic Luxury Series 30 x 51 -Inch Walk-in Tub With Soaker System - Left-Hand Drain	198 lb 89.9 kg	3051.115.SLL	Linen	9,237
		3051.115.SLW	White	9,237
Acrylic Luxury Series 30 x 51 -Inch Walk-in Tub With Soaker System - Right-Hand Drain		3051.115.SRL	Linen	9,237
		3051.115.SRW	White	9,237
Acrylic Luxury Series 30 x 51 -Inch Walk-in Tub With Whirlpool System - Left-Hand Drain	222 lb 100.8 kg	3051.115.WLL	Linen	11,455
		3051.115.WLW	White	11,455
Acrylic Luxury Series 30 x 51 -Inch Walk-in Tub With Whirlpool System - Right-Hand Drain		3051.115.WRL	Linen	11,455
		3051.115.WRW	White	11,455
Acrylic Luxury Series 30 x 51 -Inch Walk-in Tub With Air Spa System - Left-Hand Drain	214 lb 97.2 kg	3051.115.ALL	Linen	12,010
		3051.115.ALW	White	12,010
Acrylic Luxury Series 30 x 51 -Inch Walk-in Tub With Air Spa System - Right-Hand Drain		3051.115.ARL	Linen	12,010
		3051.115.ARW	White	12,010
Acrylic Luxury Series 30 x 51 -Inch Walk-in Tub With Combination Air Spa and Whirlpool Systems - Left-Hand Drain	238 lb 108.1 kg	3051.115.CLL	Linen	13,008
		3051.115.CLW	White	13,008
Acrylic Luxury Series 30 x 51 -Inch Walk-in Tub With Combination Air Spa and Whirlpool Systems - Right-Hand Drain With Faucet		3051.115.CRL	Linen	13,008
		3051.115.CRW	White	13,008

NOTE: American Standard Walk-in Baths cannot be combined with any other American Standard product orders and are not eligible for any rebates or other discount programs. For more information or to place orders please call: 1-866-423-0800 or fax: 888-872-3044

*Only available on Whirlpool and Combination Systems †Only available on Combination Systems

‡Only available on Air Spa and Combination Systems



- Premium cast acrylic construction
- Patented Quick Drain® fast water removal system
- Warranty: lifetime on the door seal, 15-years on the tub shell, 10-years on components
- Patented watertight door system
- Built-in 17" (432 mm) chair height seat
- Built-in color-matched grab bar
- Textured tub floor
- Color-matched waste and overflow
- Freestanding metal support frame
- In-line water heater*
- Neck pillow
- Chromatherapy multi-colored light system†
- 13 Water jets*
- 26 Air jets‡
- Ozone sanitation*
- Legs-only massage setting*
- Extension kit to fit 60" (1524 mm) space
- Premium faucet with multi-function handheld shower in Polished Chrome included

Nominal Dimensions:

48 in x 28 in x 37-1/2 in (1219 mm x 711 mm x 952 mm)

Description	Net Wt	SKU	Color	List Price
Acrylic Luxury Series 28 x 48-Inch Walk-in Tub With Soaker System - Left-Hand Drain With Faucet	138 lb 62.7 kg	2848.119.SLL	Linen	9,140
		2848.119.SLW	White	9,140
Acrylic Luxury Series 28 x 48-Inch Walk-in Tub With Soaker System - Right-Hand Drain With Faucet		2848.119.SRL	Linen	9,140
		2848.119.SRW	White	9,140
Acrylic Luxury Series 28 x 48-Inch Walk-in Tub With Whirlpool System - Left-Hand Drain With Faucet	162 lb 73.5 kg	2848.119.WLL	Linen	11,220
		2848.119.WLW	White	11,220
Acrylic Luxury Series 28 x 48-Inch Walk-in Tub With Whirlpool System - Right-Hand Drain With Faucet		2848.119.WRL	Linen	11,220
		2848.119.WRW	White	11,220
Acrylic Luxury Series 28 x 48-Inch Walk-in Tub With Air Spa System - Left-Hand Drain With Faucet	154 lb 69.9 kg	2848.119.ALL	Linen	11,774
		2848.119.ALW	White	11,774
Acrylic Luxury Series 28 x 48-Inch Walk-in Tub With Air Spa System - Right-Hand Drain With Faucet		2848.119.ARL	Linen	11,774
		2848.119.ARW	White	11,774
Acrylic Luxury Series 28 x 48-Inch Walk-in Tub With Combination Air Spa and Whirlpool Systems - Left-Hand Drain With Faucet	178 lb 80.8 kg	2848.119.CLL	Linen	12,773
		2848.119.CLW	White	12,773
Acrylic Luxury Series 28 x 48-Inch Walk-in Tub With Combination Air Spa and Whirlpool Systems - Right-Hand Drain With Faucet		2848.119.CRL	Linen	12,773
		2848.119.CRW	White	12,773

NOTE: American Standard Walk-in Baths cannot be combined with any other American Standard product orders and are not eligible for any rebates or other discount programs. For more information or to place orders please call: 1-866-423-0800 or fax: 888-872-3044

*Only available on Whirlpool and Combination Systems †Only available on Combination Systems

‡Only available on Air Spa and Combination Systems



- Premium cast acrylic construction
- Patented Quick Drain® fast water removal system
- Warranty: lifetime on the door seal, 15-years on the tub shell, 10-years on components
- Patented watertight door system
- Built-in 17" (432 mm) chair height seat
- Built-in color-matched grab bar
- Textured tub floor
- Color-matched waste and overflow
- Freestanding metal support frame
- In-line water heater*
- Neck pillow
- Chromatherapy multi-colored light system†
- 13 Water jets*
- 26 Air jets‡
- Ozone sanitation*
- Legs-only massage setting*
- Extension kit to fit 60" (1524 mm) space

Nominal Dimensions:

48 in x 28 in x 37-1/2 in (1219 mm x 711 mm x 952 mm)

Description	Net Wt	SKU	Color	List Price
Acrylic Luxury Series 28 x 48-Inch Walk-in Tub With Soaker System - Left-Hand Drain	172 lb 78.1 kg	2848.115.SLL	Linen	8,622
		2848.115.SLW	White	8,622
Acrylic Luxury Series 28 x 48-Inch Walk-in Tub With Soaker System - Right-Hand Drain		2848.115.SRL	Linen	8,622
		2848.115.SRW	White	8,622
Acrylic Luxury Series 28 x 48-Inch Walk-in Tub With Whirlpool System - Left-Hand Drain	196 lb 89.0 kg	2848.115.WLL	Linen	10,701
		2848.115.WLW	White	10,701
Acrylic Luxury Series 28 x 48-Inch Walk-in Tub With Whirlpool System - Right-Hand Drain		2848.115.WRL	Linen	10,701
		2848.115.WRW	White	10,701
Acrylic Luxury Series 28 x 48-Inch Walk-in Tub With Air Spa System - Left-Hand Drain	188 lb 85.4 kg	2848.115.ALL	Linen	11,256
		2848.115.ALW	White	11,256
Acrylic Luxury Series 28 x 48-Inch Walk-in Tub With Air Spa System - Right-Hand Drain		2848.115.ARL	Linen	11,256
		2848.115.ARW	White	11,256
Acrylic Luxury Series 28 x 48-Inch Walk-in Tub With Combination Air Spa and Whirlpool Systems - Left-Hand Drain	212 lb 96.2 kg	2848.115.CLL	Linen	12,254
		2848.115.CLW	White	12,254
Acrylic Luxury Series 28 x 48-Inch Walk-in Tub With Combination Air Spa and Whirlpool Systems - Right-Hand Drain With Faucet		2848.115.CRL	Linen	12,254
		2848.115.CRW	White	12,254

NOTE: American Standard Walk-in Baths cannot be combined with any other American Standard product orders and are not eligible for any rebates or other discount programs. For more information or to place orders please call: 1-866-423-0800 or fax: 888-872-3044

*Only available on Whirlpool and Combination Systems †Only available on Combination Systems

‡Only available on Air Spa and Combination Systems



- Premium gelcoat construction
- Patented Quick Drain® fast water removal system
- Warranty: lifetime on the door seal, 10-years on the tub shell, 5-years on components
- Watertight door system
- Built-in 17" (432 mm) chair height seat
- Built-in color-matched grab bar
- Color-matched waste and overflow
- Textured tub floor
- Freestanding metal support frame
- In-line water heater*
- Neck pillow
- Chromatherapy multi-colored light system†
- 13 Water jets*
- 26 Air jets‡
- Ozone sanitation*
- Legs-only massage setting*
- Premium faucet with multi-function handheld shower in polished chrome included

Nominal Dimensions:

59-1/2 in x 29-3/4 in x 37-1/2 in (1511 mm x 755 mm x 952 mm)

Description	Net Wt	SKU	Color	List Price
Gelcoat Premium Series 30 x 60 -Inch Walk-in Tub With Soaker System - Left-Hand Drain With Faucet	141 lb 64.0 kg	3060.109.SLL	Linen	9,288
		3060.109.SLW	White	9,288
Gelcoat Premium Series 30 x 60 -Inch Walk-in Tub With Soaker System - Right-Hand Drain With Faucet	141 lb 64.0 kg	3060.109.SRL	Linen	9,288
		3060.109.SRW	White	9,288
Gelcoat Premium Series 30 x 60 -Inch Walk-in Tub With Whirlpool System - Left-Hand Drain With Faucet	165 lb 74.9 kg	3060.109.WLL	Linen	10,814
		3060.109.WLW	White	10,814
Gelcoat Premium Series 30 x 60 -Inch Walk-in Tub With Whirlpool System - Right-Hand Drain With Faucet	165 lb 74.9 kg	3060.109.WRL	Linen	10,814
		3060.109.WRW	White	10,814
Gelcoat Premium Series 30 x 60 -Inch Walk-in Tub With Air Spa System - Left-Hand Drain With Faucet	125 lb 56.7 kg	3060.109.ALL	Linen	11,366
		3060.109.ALW	White	11,366
Gelcoat Premium Series 30 x 60 -Inch Walk-in Tub With Air Spa System - Right-Hand Drain With Faucet	125 lb 56.7 kg	3060.109.ARL	Linen	11,366
		3060.109.ARW	White	11,366
Gelcoat Premium Series 30 x 60 -Inch Walk-in Tub With Combination Air Spa and Whirlpool Systems - Left-Hand Drain With Faucet	149 lb 67.6 kg	3060.109.CLL	Linen	12,366
		3060.109.CLW	White	12,366
Gelcoat Premium Series 30 x 60 -Inch Walk-in Tub With Combination Air Spa and Whirlpool Systems - Right-Hand Drain With Faucet	149 lb 67.6 kg	3060.109.CRL	Linen	12,366
		3060.109.CRW	White	12,366

NOTE: American Standard Walk-in Baths cannot be combined with any other American Standard product orders and are not eligible for any rebates or other discount programs. For more information or to place orders please call: 1-866-423-0800 or fax: 888-872-3044

*Only available on Whirlpool and Combination Systems †Only available on Combination Systems

‡Only available on Air Spa and Combination Systems



- Premium gelcoat construction
- Patented Quick Drain® fast water removal system
- Warranty: lifetime on the door seal, 10-years on the tub shell, 5-years on components
- Watertight door system
- Built-in 17" (432 mm) chair height seat
- Built-in color-matched grab bar
- Color-matched waste and overflow
- Textured tub floor
- Freestanding metal support frame
- In-line water heater*
- Neck pillow
- Chromatherapy multi-colored light system†
- 13 Water jets*
- 26 Air jets‡
- Ozone sanitation*
- Legs-only massage setting*

Nominal Dimensions:

59-1/2 in x 29-3/4 in x 37-1/2 in (1511 mm x 755 mm x 952 mm)

Description	Net Wt	SKU	Color	List Price
Gelcoat Premium Series 30 x 60 -Inch Walk-in Tub With Soaker System - Left-Hand Drain	132 lb 59.9 kg	3060.105.SLL	Linen	8,769
		3060.105.SLW	White	8,769
Gelcoat Premium Series 30 x 60 -Inch Walk-in Tub With Soaker System - Right-Hand Drain		3060.105.SRL	Linen	8,769
		3060.105.SRW	White	8,769
Gelcoat Premium Series 30 x 60 -Inch Walk-in Tub With Whirlpool System - Left-Hand Drain	169 lb 76.7 kg	3060.105.WLL	Linen	10,295
		3060.105.WLW	White	10,295
Gelcoat Premium Series 30 x 60 -Inch Walk-in Tub With Whirlpool System - Right-Hand Drain		3060.105.WRL	Linen	10,295
		3060.105.WRW	White	10,295
Gelcoat Premium Series 30 x 60 -Inch Walk-in Tub With Air Spa System - Left-Hand Drain	158 lb 71.7 kg	3060.105.ALL	Linen	10,849
		3060.105.ALW	White	10,849
Gelcoat Premium Series 30 x 60 -Inch Walk-in Tub With Air Spa System - Right-Hand Drain		3060.105.ARL	Linen	10,849
		3060.105.ARW	White	10,849
Gelcoat Premium Series 30 x 60 -Inch Walk-in Tub With Combination Air Spa and Whirlpool Systems - Left-Hand Drain	189 lb 85.8 kg	3060.105.CLL	Linen	11,847
		3060.105.CLW	White	11,847
Gelcoat Premium Series 30 x 60 -Inch Walk-in Tub With Combination Air Spa and Whirlpool Systems - Hand Drain With Faucet		3060.105.CRL	Linen	11,847
		3060.105.CRW	White	11,847

NOTE: American Standard Walk-in Baths cannot be combined with any other American Standard product orders and are not eligible for any rebates or other discount programs. For more information or to place orders please call: 1-866-423-0800 or fax: 888-872-3044

*Only available on Whirlpool and Combination Systems †Only available on Combination Systems

‡Only available on Air Spa and Combination Systems



- Premium gelcoat construction
- Patented Quick Drain® fast water removal system
- Warranty: lifetime on the door seal, 10-years on the tub shell, 5-years on components
- Watertight door system
- Built-in 17" (432 mm) chair height seat
- Built-in color-matched grab bar
- Color-matched waste and overflow
- Textured tub floor
- Freestanding metal support frame
- In-line water heater*
- Neck pillow
- Chromatherapy multi-colored light system†
- 13 Water jets*
- 26 Air jets‡
- Ozone sanitation*
- Legs-only massage setting*
- Extension kit to fit 60" (1524 mm) space
- Premium faucet with multi-function handheld shower in Polished Chrome included

Nominal Dimensions:

51-1/2 in x 29-3/4 in x 42 in (1308 mm x 755 mm x 1066 mm)

Description	Net Wt	SKU	Color	List Price
Gelcoat Premium Series 30 x 52 -Inch Walk-in Tub With Soaker System - Left-Hand Drain With Faucet	141 lb 64.0 kg	3052.109.SLL	Linen	8,039
		3052.109.SLW	White	8,039
Gelcoat Premium Series 30 x 52 -Inch Walk-in Tub With Soaker System - Right-Hand Drain With Faucet		3052.109.SRL	Linen	8,039
		3052.109.SRW	White	8,039
Gelcoat Premium Series 30 x 52 -Inch Walk-in Tub With Whirlpool System - Left-Hand Drain With Faucet	165 lb 74.9 kg	3052.109.WLL	Linen	9,713
		3052.109.WLW	White	9,713
Gelcoat Premium Series 30 x 52 -Inch Walk-in Tub With Whirlpool System - Right-Hand Drain With Faucet		3052.109.WRL	Linen	9,713
		3052.109.WRW	White	9,713
Gelcoat Premium Series 30 x 52 -Inch Walk-in Tub With Air Spa System - Left-Hand Drain With Faucet	125 lb 56.7 kg	3052.109.ALL	Linen	10,396
		3052.109.ALW	White	10,396
Gelcoat Premium Series 30 x 52 -Inch Walk-in Tub With Air Spa System - Right-Hand Drain With Faucet		3052.109.ARL	Linen	10,396
		3052.109.ARW	White	10,396
Gelcoat Premium Series 30 x 52 -Inch Walk-in Tub With Combination Air Spa and Whirlpool Systems - Left-Hand Drain With Faucet	149 lb 67.6 kg	3052.109.CLL	Linen	11,395
		3052.109.CLW	White	11,395
Gelcoat Premium Series 30 x 52 -Inch Walk-in Tub With Combination Air Spa and Whirlpool Systems - Right-Hand Drain With Faucet		3052.109.CRL	Linen	11,395
		3052.109.CRW	White	11,395

NOTE: American Standard Walk-in Baths cannot be combined with any other American Standard product orders and are not eligible for any rebates or other discount programs. For more information or to place orders please call: 1-866-423-0800 or fax: 888-872-3044

*Only available on Whirlpool and Combination Systems †Only available on Combination Systems

‡Only available on Air Spa and Combination Systems



- Premium gelcoat construction
- Patented Quick Drain® fast water removal system
- Warranty: lifetime on the door seal, 10-years on the tub shell, 5-years on components
- Watertight door system
- Built-in 17" (432 mm) chair height seat
- Built-in color-matched grab bar
- Color-matched waste and overflow
- Textured tub floor
- Freestanding metal support frame
- In-line water heater*
- Neck pillow
- Chromatherapy multi-colored light system†
- 13 Water jets*
- 26 Air jets‡
- Ozone sanitation*
- Legs-only massage setting*
- Extension kit to fit 60" (1524 mm) space

Nominal Dimensions:

51-1/2 in x 29-3/4 in x 42 in (1308 mm x 755 mm x 1066 mm)

Description	Net Wt	SKU	Color	List Price
Gelcoat Premium Series 30 x 52 -Inch Walk-in Tub With Soaker System - Left-Hand Drain	138 lb 62.7 kg	3052.105.SLL	Linen	7,522
		3052.105.SLW	White	7,522
Gelcoat Premium Series 30 x 52 -Inch Walk-in Tub With Soaker System - Right-Hand Drain	138 lb 62.7 kg	3052.105.SRL	Linen	7,522
		3052.105.SRW	White	7,522
Gelcoat Premium Series 30 x 52 -Inch Walk-in Tub With Whirlpool System - Left-Hand Drain	162 lb 73.5 kg	3052.105.WLL	Linen	9,195
		3052.105.WLW	White	9,195
Gelcoat Premium Series 30 x 52 -Inch Walk-in Tub With Whirlpool System - Right-Hand Drain	162 lb 73.5 kg	3052.105.WRL	Linen	9,195
		3052.105.WRW	White	9,195
Gelcoat Premium Series 30 x 52 -Inch Walk-in Tub With Air Spa System - Left-Hand Drain	154 lb 69.9 kg	3052.105.ALL	Linen	9,878
		3052.105.ALW	White	9,878
Gelcoat Premium Series 30 x 52 -Inch Walk-in Tub With Air Spa System - Right-Hand Drain	154 lb 69.9 kg	3052.105.ARL	Linen	9,878
		3052.105.ARW	White	9,878
Gelcoat Premium Series 30 x 52 -Inch Walk-in Tub With Combination Air Spa and Whirlpool Systems - Left-Hand Drain	178 lb 80.8 kg	3052.105.CLL	Linen	10,877
		3052.105.CLW	White	10,877
Gelcoat Premium Series 30 x 52 -Inch Walk-in Tub With Combination Air Spa and Whirlpool Systems - Right-Hand Drain With Faucet	178 lb 80.8 kg	3052.105.CRL	Linen	10,877
		3052.105.CRW	White	10,877

NOTE: American Standard Walk-in Baths cannot be combined with any other American Standard product orders and are not eligible for any rebates or other discount programs. For more information or to place orders please call: 1-866-423-0800 or fax: 888-872-3044

*Only available on Whirlpool and Combination Systems †Only available on Combination Systems

‡Only available on Air Spa and Combination Systems



- Premium gelcoat construction
- Patented Quick Drain® fast water removal system
- Warranty: lifetime on the door seal, 10-years on the tub shell, 5-years on components
- Watertight door system
- Built-in 17" (432 mm) chair height seat
- Built-in color-matched grab bar
- Color-matched waste and overflow
- Textured tub floor
- Freestanding metal support frame
- In-line water heater*
- Neck pillow
- Chromatherapy multi-colored light system†
- 13 Water jets*
- 26 Air jets‡
- Ozone sanitation*
- Legs-only massage setting*
- Extension kit to fit 60" (1524 mm) space
- Premium faucet with multi-function handheld shower in Polished Chrome included

Nominal Dimensions:

48 in x 28-1/2 in x 37-1/2 in (1219 mm x 723 mm x 952 mm)

Description	Net Wt	SKU	Color	List Price
Gelcoat Premium Series 28 x 48-Inch Walk-in Tub With Soaker System - Left-Hand Drain With Faucet	141 lb 64.0 kg	2848.109.SLL	Linen	7,684
		2848.109.SLW	White	7,684
Gelcoat Premium Series 28 x 48-Inch Walk-in Tub With Soaker System - Right-Hand Drain With Faucet	141 lb 64.0 kg	2848.109.SRL	Linen	7,684
		2848.109.SRW	White	7,684
Gelcoat Premium Series 28 x 48-Inch Walk-in Tub With Whirlpool System - Left-Hand Drain With Faucet	165 lb 74.9 kg	2848.109.WLL	Linen	9,071
		2848.109.WLW	White	9,071
Gelcoat Premium Series 28 x 48-Inch Walk-in Tub With Whirlpool System - Right-Hand Drain With Faucet	165 lb 74.9 kg	2848.109.WRL	Linen	9,071
		2848.109.WRW	White	9,071
Gelcoat Premium Series 28 x 48-Inch Walk-in Tub With Air Spa System - Left-Hand Drain With Faucet	125 lb 56.7 kg	2848.109.ALL	Linen	9,626
		2848.109.ALW	White	9,626
Gelcoat Premium Series 28 x 48-Inch Walk-in Tub With Air Spa System - Right-Hand Drain With Faucet	125 lb 56.7 kg	2848.109.ARL	Linen	9,626
		2848.109.ARW	White	9,626
Gelcoat Premium Series 28 x 48-Inch Walk-in Tub With Combination Air Spa and Whirlpool Systems - Left-Hand Drain With Faucet	149 lb 67.6 kg	2848.109.CLL	Linen	10,761
		2848.109.CLW	White	10,761
Gelcoat Premium Series 28 x 48-Inch Walk-in Tub With Combination Air Spa and Whirlpool Systems - Right-Hand Drain With Faucet	149 lb 67.6 kg	2848.109.CRL	Linen	10,761
		2848.109.CRW	White	10,761

NOTE: American Standard Walk-in Baths cannot be combined with any other American Standard product orders and are not eligible for any rebates or other discount programs. For more information or to place orders please call: 1-866-423-0800 or fax: 888-872-3044

*Only available on Whirlpool and Combination Systems †Only available on Combination Systems

‡Only available on Air Spa and Combination Systems



- Premium gelcoat construction
- Patented Quick Drain® fast water removal system
- Warranty: lifetime on the door seal, 10-years on the tub shell, 5-years on components
- Watertight door system
- Built-in 17" (432 mm) chair height seat
- Built-in color-matched grab bar
- Color-matched waste and overflow
- Textured tub floor
- Freestanding metal support frame
- In-line water heater*
- Neck pillow
- Chromatherapy multi-colored light system†
- 13 Water jets*
- 26 Air jets‡
- Ozone sanitation*
- Legs-only massage setting*
- Extension kit to fit 60" (1524 mm) space

Nominal Dimensions:

48 in x 28-1/2 in x 37-1/2 in (1219 mm x 723 mm x 952 mm)

Description	Net Wt	SKU	Color	List Price
Gelcoat Premium Series 28 x 48-Inch Walk-in Tub With Soaker System - Left-Hand Drain	125 lb 56.7 kg	2848.105.SLL	Linen	7,165
		2848.105.SLW	White	7,165
Gelcoat Premium Series 28 x 48-Inch Walk-in Tub With Soaker System - Right-Hand Drain	125 lb 56.7 kg	2848.105.SRL	Linen	7,165
		2848.105.SRW	White	7,165
Gelcoat Premium Series 28 x 48-Inch Walk-in Tub With Whirlpool System - Left-Hand Drain	149 lb 67.6 kg	2848.105.WLL	Linen	8,553
		2848.105.WLW	White	8,553
Gelcoat Premium Series 28 x 48-Inch Walk-in Tub With Whirlpool System - Right-Hand Drain	149 lb 67.6 kg	2848.105.WRL	Linen	8,553
		2848.105.WRW	White	8,553
Gelcoat Premium Series 28 x 48-Inch Walk-in Tub With Air Spa System - Left-Hand Drain	141 lb 64.0 kg	2848.105.ALL	Linen	9,107
		2848.105.ALW	White	9,107
Gelcoat Premium Series 28 x 48-Inch Walk-in Tub With Air Spa System - Right-Hand Drain	141 lb 64.0 kg	2848.105.ARL	Linen	9,107
		2848.105.ARW	White	9,107
Gelcoat Premium Series 28 x 48-Inch Walk-in Tub With Combination Air Spa and Whirlpool Systems - Left-Hand Drain	165 lb 74.9 kg	2848.105.CLL	Linen	10,243
		2848.105.CLW	White	10,243
Gelcoat Premium Series 28 x 48-Inch Walk-in Tub With Combination Air Spa and Whirlpool Systems - Right-Hand Drain With Faucet	165 lb 74.9 kg	2848.105.CRL	Linen	10,243
		2848.105.CRW	White	10,243

NOTE: American Standard Walk-in Baths cannot be combined with any other American Standard product orders and are not eligible for any rebates or other discount programs. For more information or to place orders please call: 1-866-423-0800 or fax: 888-872-3044

*Only available on Whirlpool and Combination Systems †Only available on Combination Systems

‡Only available on Air Spa and Combination Systems



- Premium gelcoat construction
- Patented Quick Drain® fast water removal system
- Warranty: lifetime on the door seal, 10-years on the tub shell, 5-years on components
- Patented watertight door system
- Built-in 17" (432 mm) chair height seat
- Built-in color-matched grab bar
- Textured tub floor
- Freestanding metal support frame
- Color-matched cable driven drain assembly
- In-line water heater*
- 8 Water jets*
- 21 Air jets†
- Legs-only massage setting*
- Premium faucet with handheld shower in polished chrome included

Nominal Dimensions:

59-1/2 in x 29-3/4 in x 37-1/2 in (1511 mm x 755 mm x 952 mm)

Description	Net Wt	SKU	Color	List Price
Gelcoat Value Series 30 x 60 -Inch Walk-in Tub With Soaker System - Left-Hand Drain With Faucet	150 lb 68.1 kg	3060.509.SLL	Linen	6,978
		3060.509.SLW	White	6,978
Gelcoat Value Series 30 x 60 -Inch Walk-in Tub With Soaker System - Right-Hand Drain With Faucet		3060.509.SRL	Linen	6,978
		3060.509.SRW	White	6,978
Gelcoat Value Series 30 x 60 -Inch Walk-in Tub With Whirlpool System - Left-Hand Drain With Faucet	174 lb 79.0 kg	3060.509.WLL	Linen	7,667
		3060.509.WLW	White	7,667
Gelcoat Value Series 30 x 60 -Inch Walk-in Tub With Whirlpool System - Right-Hand Drain With Faucet		3060.509.WRL	Linen	7,667
		3060.509.WRW	White	7,667
Gelcoat Value Series 30 x 60 -Inch Walk-in Tub With Air Spa System - Left-Hand Drain With Faucet	166 lb 75.4 kg	3060.509.ALL	Linen	8,144
		3060.509.ALW	White	8,144
Gelcoat Value Series 30 x 60 -Inch Walk-in Tub With Air Spa System - Right-Hand Drain With Faucet		3060.509.ARL	Linen	8,144
		3060.509.ARW	White	8,144
Gelcoat Value Series 30 x 60 -Inch Walk-in Tub With Combination Air Spa and Whirlpool Systems - Left-Hand Drain With Faucet	190 lb 86.3 kg	3060.509.CLL	Linen	8,777
		3060.509.CLW	White	8,777
Gelcoat Value Series 30 x 60 -Inch Walk-in Tub With Combination Air Spa and Whirlpool Systems - Right-Hand Drain With Faucet		3060.509.CRL	Linen	8,777
		3060.509.CRW	White	8,777

NOTE: American Standard Walk-in Baths cannot be combined with any other American Standard product orders and are not eligible for any rebates or other discount programs. For more information or to place orders please call: 1-866-423-0800 or fax: 888-872-3044

*Only available on Whirlpool and Combination Systems †Only available on Combination Systems

‡Only available on Air Spa and Combination Systems



- Premium gelcoat construction
- Patented Quick Drain® fast water removal system
- Warranty: lifetime on the door seal, 10-years on the tub shell, 5-years on components
- Patented watertight door system
- Built-in 17" (432 mm) chair height seat
- Built-in color-matched grab bar
- Textured tub floor
- Freestanding metal support frame
- Extension kit to fit 60" (1524 mm) space
- Color-matched cable driven drain assembly
- In-line water heater*
- 8 Water jets*
- 21 Air jets†
- Legs-only massage setting*
- Premium faucet with handheld shower in polished chrome included

Nominal Dimensions:

51-1/2 in x 29-3/4 in x 42 in (1308 mm x 755 mm x 1066 mm)

Description	Net Wt	SKU	Color	List Price
Gelcoat Value Series 30 x 52 -Inch Walk-in Tub With Soaker System - Left-Hand Drain With Faucet	152 lb 69.0 kg	3052.509.SLL	Linen	6,461
		3052.509.SLW	White	6,461
Gelcoat Value Series 30 x 52 -Inch Walk-in Tub With Soaker System - Right-Hand Drain With Faucet		3052.509.SRL	Linen	6,461
		3052.509.SRW	White	6,461
Gelcoat Value Series 30 x 52 -Inch Walk-in Tub With Whirlpool System - Left-Hand Drain With Faucet	176 lb 79.9 kg	3052.509.WLL	Linen	7,277
		3052.509.WLW	White	7,277
Gelcoat Value Series 30 x 52 -Inch Walk-in Tub With Whirlpool System - Right-Hand Drain With Faucet		3052.509.WRL	Linen	7,277
		3052.509.WRW	White	7,277
Gelcoat Value Series 30 x 52 -Inch Walk-in Tub With Air Spa System - Left-Hand Drain With Faucet	168 lb 76.3 kg	3052.509.ALL	Linen	7,866
		3052.509.ALW	White	7,866
Gelcoat Value Series 30 x 52 -Inch Walk-in Tub With Air Spa System - Right-Hand Drain With Faucet		3052.509.ARL	Linen	7,866
		3052.509.ARW	White	7,866
Gelcoat Value Series 30 x 52 -Inch Walk-in Tub With Combination Air Spa and Whirlpool Systems - Left-Hand Drain With Faucet	192 lb 87.2 kg	3052.509.CLL	Linen	8,502
		3052.509.CLW	White	8,502
Gelcoat Value Series 30 x 52 -Inch Walk-in Tub With Combination Air Spa and Whirlpool Systems - Right-Hand Drain With Faucet		3052.509.CRL	Linen	8,502
		3052.509.CRW	White	8,502

NOTE: American Standard Walk-in Baths cannot be combined with any other American Standard product orders and are not eligible for any rebates or other discount programs. For more information or to place orders please call: 1-866-423-0800 or fax: 888-872-3044

*Only available on Whirlpool and Combination Systems †Only available on Combination Systems

‡Only available on Air Spa and Combination Systems



- Premium gelcoat construction
- Patented Quick Drain® fast water removal system
- Warranty: lifetime on the door seal, 10-years on the tub shell, 5-years on components
- Patented watertight door system
- Built-in 17" (432 mm) chair height seat
- Built-in color-matched grab bar
- Textured tub floor
- Freestanding metal support frame
- Extension kit to fit 60" (1524 mm) space
- Color-matched cable driven drain assembly
- In-line water heater*
- 8 Water jets*
- 21 Air jets†
- Legs-only massage setting*
- Premium faucet with handheld shower in polished chrome included

Nominal Dimensions:

48 in x 28-1/2 in x 37-1/2 in (1219 mm x 723 mm x 952 mm)

Description	Net Wt	SKU	Color	List Price
Gelcoat Value Series 28 x 48-Inch Walk-in Tub With Soaker System - Left-Hand Drain With Faucet	125 lb 56.7 kg	2848.509.SLL	Linen	6,156
		2848.509.SLW	White	6,156
Gelcoat Value Series 28 x 48-Inch Walk-in Tub With Soaker System - Right-Hand Drain With Faucet		2848.509.SRL	Linen	6,156
		2848.509.SRW	White	6,156
Gelcoat Value Series 28 x 48-Inch Walk-in Tub With Whirlpool System - Left-Hand Drain With Faucet	149 lb 67.6 kg	2848.509.WLL	Linen	6,904
		2848.509.WLW	White	6,904
Gelcoat Value Series 28 x 48-Inch Walk-in Tub With Whirlpool System - Right-Hand Drain With Faucet		2848.509.WRL	Linen	6,904
		2848.509.WRW	White	6,904
Gelcoat Value Series 28 x 48-Inch Walk-in Tub With Air Spa System - Left-Hand Drain With Faucet	141 lb 64.0 kg	2848.509.ALL	Linen	7,425
		2848.509.ALW	White	7,425
Gelcoat Value Series 28 x 48-Inch Walk-in Tub With Air Spa System - Right-Hand Drain With Faucet		2848.509.ARL	Linen	7,425
		2848.509.ARW	White	7,425
Gelcoat Value Series 28 x 48-Inch Walk-in Tub With Combination Air Spa and Whirlpool Systems - Left-Hand Drain With Faucet	165 lb 74.9 kg	2848.509.CLL	Linen	8,022
		2848.509.CLW	White	8,022
Gelcoat Value Series 28 x 48-Inch Walk-in Tub With Combination Air Spa and Whirlpool Systems - Right-Hand Drain With Faucet		2848.509.CRL	Linen	8,022
		2848.509.CRW	White	8,022

NOTE: American Standard Walk-in Baths cannot be combined with any other American Standard product orders and are not eligible for any rebates or other discount programs. For more information or to place orders please call: 1-866-423-0800 or fax: 888-872-3044

*Only available on Whirlpool and Combination Systems †Only available on Combination Systems

‡Only available on Air Spa and Combination Systems



Gelcoat Walk-In-Baths With Outward Opening Door

Providing a safer and comfortable way for adults to bathe.

The watertight door swings outward to provide more room when entering and exiting the bath.

Allows for immediate access to the bather in the event of a medical emergency.



- Premium gelcoat construction
- Patented Quick Drain® fast water removal system
- Warranty: lifetime on the door seal, 10-years on the tub shell, 5-years on components
- Outward opening door
- Water tight door system
- Built-in chair height seat
- Built-in polished chrome grab bar
- Textured tub floor
- Freestanding metal support frame
- In-line water heater*
- Extension kit to fit 60" (1524 mm) space
- Neck pillow
- Chromatherapy multi-colored light system†
- 12 Water jets‡
- 26 Air jets‡
- Ozone sanitation*
- Legs-only massage setting*
- Premium faucet with multi-function handheld shower in Polished Chrome included

Nominal Dimensions:

52 in x 32 in x 40 in (1320 mm x 812 mm x 1016 mm)

Description	Net Wt	SKU	Color	List Price
Gelcoat Premium Series 32 x 52 -Inch Walk-in Tub With Soaker System - Left-Hand Drain With Faucet	138 lb 62.7 kg	3252OD.109.SLL-PC	Linen	9,066
		3252OD.109.SLW-PC	White	9,066
Gelcoat Premium Series 32 x 52 -Inch Walk-in Tub With Soaker System - Right-Hand Drain With Faucet	138 lb 62.7 kg	3252OD.109.SRL-PC	Linen	9,066
		3252OD.109.SRW-PC	White	9,066
Gelcoat Premium Series 32 x 52 -Inch Walk-in Tub With Whirlpool System - Left-Hand Drain With Faucet	162 lb 73.5 kg	3252OD.109.WLL-PC	Linen	10,988
		3252OD.109.WLW-PC	White	10,988
Gelcoat Premium Series 32 x 52 -Inch Walk-in Tub With Whirlpool System - Right-Hand Drain With Faucet	162 lb 73.5 kg	3252OD.109.WRL-PC	Linen	10,988
		3252OD.109.WRW-PC	White	10,988
Gelcoat Premium Series 32 x 52 -Inch Walk-in Tub With Air Spa System - Left-Hand Drain With Faucet	154 lb 69.9 kg	3252OD.109.ALL-PC	Linen	11,603
		3252OD.109.ALW-PC	White	11,603
Gelcoat Premium Series 32 x 52 -Inch Walk-in Tub With Air Spa System - Right-Hand Drain With Faucet	154 lb 69.9 kg	3252OD.109.ARL-PC	Linen	11,603
		3252OD.109.ARW-PC	White	11,603
Gelcoat Premium Series 32 x 52 -Inch Walk-in Tub With Combination Air Spa and Whirlpool Systems - Left-Hand Drain With Faucet	178 lb 80.8 kg	3252OD.109.CLL-PC	Linen	11,867
		3252OD.109.CLW-PC	White	11,867
Gelcoat Premium Series 32 x 52 -Inch Walk-in Tub With Combination Air Spa and Whirlpool Systems - Right-Hand Drain With Faucet	178 lb 80.8 kg	3252OD.109.CRL-PC	Linen	11,867
		3252OD.109.CRW-PC	White	11,867

NOTE: American Standard Walk-in Baths cannot be combined with any other American Standard product orders and are not eligible for any rebates or other discount programs.

For more information or to place orders please call: 1-866-423-0800 or fax: 888-872-3044

*Only available on Whirlpool and Combination Systems

†Only available on Combination Systems

‡Only available on Air Spa and Combination Systems



- Premium gelcoat construction
- Patented Quick Drain® fast water removal system
- Warranty: lifetime on the door seal, 10-years on the tub shell, 5-years on components
- Outward opening door
- Water tight door system
- Built-in chair height seat
- Built-in polished chrome grab bar
- Textured tub floor
- Freestanding metal support frame
- In-line water heater*
- Extension kit to fit 60" (1524 mm) space
- Neck pillow
- Chromatherapy multi-colored light system†
- 12 Water jets*
- 26 Air jets‡
- Ozone sanitation*
- Legs-only massage setting*

Nominal Dimensions:

52 in x 32 in x 40 in (1320 mm x 812 mm x 1016 mm)

Description	Net Wt	SKU	Color	List Price
Gelcoat Premium Series 32 x 52 -Inch Walk-in Tub With Soaker System - Left-Hand Drain	150 lb 68.1 kg	3252OD.105.SLL-PC	Linen	8,525
		3252OD.105.SLW-PC	White	8,525
Gelcoat Premium Series 32 x 52 -Inch Walk-in Tub With Soaker System - Right-Hand Drain	150 lb 68.1 kg	3252OD.105.SRL-PC	Linen	8,525
		3252OD.105.SRW-PC	White	8,525
Gelcoat Premium Series 32 x 52 -Inch Walk-in Tub With Whirlpool System - Left-Hand Drain	174 lb 79.0 kg	3252OD.105.WLL-PC	Linen	10,446
		3252OD.105.WLW-PC	White	10,446
Gelcoat Premium Series 32 x 52 -Inch Walk-in Tub With Whirlpool System - Right-Hand Drain	174 lb 79.0 kg	3252OD.105.WRL-PC	Linen	10,446
		3252OD.105.WRW-PC	White	10,446
Gelcoat Premium Series 32 x 52 -Inch Walk-in Tub With Air Spa System - Left-Hand Drain	166 lb 75.4 kg	3252OD.105.ALL-PC	Linen	11,059
		3252OD.105.ALW-PC	White	11,059
Gelcoat Premium Series 32 x 52 -Inch Walk-in Tub With Air Spa System - Right-Hand Drain	166 lb 75.4 kg	3252OD.105.ARL-PC	Linen	11,059
		3252OD.105.ARW-PC	White	11,059
Gelcoat Premium Series 32 x 52 -Inch Walk-in Tub With Combination Air Spa and Whirlpool Systems - Left-Hand Drain	223 lb 101.2 kg	3252OD.105.CLL-PC	Linen	11,325
		3252OD.105.CLW-PC	White	11,325
Gelcoat Premium Series 32 x 52 -Inch Walk-in Tub With Combination Air Spa and Whirlpool Systems - Right-Hand Drain With Faucet	223 lb 101.2 kg	3252OD.105.CRL-PC	Linen	11,325
		3252OD.105.CRW-PC	White	11,325

NOTE: American Standard Walk-in Baths cannot be combined with any other American Standard product orders and are not eligible for any rebates or other discount programs. For more information or to place orders please call: 1-866-423-0800 or fax: 888-872-3044

*Only available on Whirlpool and Combination Systems †Only available on Combination Systems

‡Only available on Air Spa and Combination Systems



- Premium gelcoat construction
- Patented Quick Drain® fast water removal system
- Warranty: lifetime on the door seal, 10-years on the tub shell, 5-years on components
- Outward opening door
- Watertight door system
- Built-in chair height seat
- Built-in Polished Chrome grab bar
- Textured tub floor
- Freestanding metal support frame
- In-line water heater*
- Extension kit to fit 60" (1524 mm) space
- Neck pillow
- Chromatherapy multi-colored light system†
- 12 Water jets*
- 26 Air jets‡
- Ozone sanitation*
- Legs-only massage setting*
- Premium faucet with multi-function handheld shower in Polished Chrome included

Nominal Dimensions:

52 in x 30 in x 40 in (1320 mm x 762 mm x 1016 mm)

Description	Net Wt	SKU	Color	List Price
Gelcoat Premium Series 30 x 52 -Inch Walk-in Tub With Soaker System - Left-Hand Drain With Faucet	138 lb 62.7 kg	3052OD.109.SLL-PC	Linen	8,397
		3052OD.109.SLW-PC	White	8,397
Gelcoat Premium Series 30 x 52 -Inch Walk-in Tub With Soaker System - Right-Hand Drain With Faucet		3052OD.109.SRL-PC	Linen	8,397
		3052OD.109.SRW-PC	White	8,397
Gelcoat Premium Series 30 x 52 -Inch Walk-in Tub With Whirlpool System - Left-Hand Drain With Faucet	162 lb 73.5 kg	3052OD.109.WLL-PC	Linen	10,317
		3052OD.109.WLW-PC	White	10,317
Gelcoat Premium Series 30 x 52 -Inch Walk-in Tub With Whirlpool System - Right-Hand Drain With Faucet		3052OD.109.WRL-PC	Linen	10,317
		3052OD.109.WRW-PC	White	10,317
Gelcoat Premium Series 30 x 52 -Inch Walk-in Tub With Air Spa System - Left-Hand Drain With Faucet	154 lb 69.9 kg	3052OD.109.ALL-PC	Linen	10,933
		3052OD.109.ALW-PC	White	10,933
Gelcoat Premium Series 30 x 52 -Inch Walk-in Tub With Air Spa System - Right-Hand Drain With Faucet		3052OD.109.ARL-PC	Linen	10,933
		3052OD.109.ARW-PC	White	10,933
Gelcoat Premium Series 30 x 52 -Inch Walk-in Tub With Combination Air Spa and Whirlpool Systems - Left-Hand Drain With Faucet	178 lb 80.8 kg	3052OD.109.CLL-PC	Linen	11,198
		3052OD.109.CLW-PC	White	11,198
Gelcoat Premium Series 30 x 52 -Inch Walk-in Tub With Combination Air Spa and Whirlpool Systems - Right-Hand Drain With Faucet		3052OD.109.CRL-PC	Linen	11,198
		3052OD.109.CRW-PC	White	11,198

NOTE: American Standard Walk-in Baths cannot be combined with any other American Standard product orders and are not eligible for any rebates or other discount programs. For more information or to place orders please call: 1-866-423-0800 or fax: 888-872-3044

*Only available on Whirlpool and Combination Systems †Only available on Combination Systems

‡Only available on Air Spa and Combination Systems



- Premium gelcoat construction
- Patented Quick Drain® fast water removal system
- Warranty: lifetime on the door seal, 10-years on the tub shell, 5-years on components
- Outward opening door
- Watertight door system
- Built-in chair height seat
- Built-in Polished Chrome grab bar
- Textured tub floor
- Freestanding metal support frame
- In-line water heater*
- Extension kit to fit 60" (1524 mm) space
- Neck pillow
- Chromatherapy multi-colored light system†
- 12 Water jets*
- 26 Air jets‡
- Ozone sanitation*
- Legs-only massage setting*

Nominal Dimensions:

52 in x 30 in x 40 in (1320 mm x 762 mm x 1016 mm)

Description	Net Wt	SKU	Color	List Price
Gelcoat Premium Series 30 x 52 -Inch Walk-in Tub With Soaker System - Left-Hand Drain	138 lb 62.7 kg	3052OD.105.SLL-PC	Linen	7,856
		3052OD.105.SLW-PC	White	7,856
Gelcoat Premium Series 30 x 52 -Inch Walk-in Tub With Soaker System - Right-Hand Drain	138 lb 62.7 kg	3052OD.105.SRL-PC	Linen	7,856
		3052OD.105.SRW-PC	White	7,856
Gelcoat Premium Series 30 x 52 -Inch Walk-in Tub With Whirlpool System - Left-Hand Drain	162 lb 73.5 kg	3052OD.105.WLL-PC	Linen	9,776
		3052OD.105.WLW-PC	White	9,776
Gelcoat Premium Series 30 x 52 -Inch Walk-in Tub With Whirlpool System - Right-Hand Drain	162 lb 73.5 kg	3052OD.105.WRL-PC	Linen	9,776
		3052OD.105.WRW-PC	White	9,776
Gelcoat Premium Series 30 x 52 -Inch Walk-in Tub With Air Spa System - Left-Hand Drain	154 lb 69.9 kg	3052OD.105.ALL-PC	Linen	10,391
		3052OD.105.ALW-PC	White	10,391
Gelcoat Premium Series 30 x 52 -Inch Walk-in Tub With Air Spa System - Right-Hand Drain	154 lb 69.9 kg	3052OD.105.ARL-PC	Linen	10,391
		3052OD.105.ARW-PC	White	10,391
Gelcoat Premium Series 30 x 52 -Inch Walk-in Tub With Combination Air Spa and Whirlpool Systems - Left-Hand Drain	178 lb 80.8 kg	3052OD.105.CLL-PC	Linen	10,655
		3052OD.105.CLW-PC	White	10,655
Gelcoat Premium Series 30 x 52 -Inch Walk-in Tub With Combination Air Spa and Whirlpool Systems - Right-Hand Drain With Faucet	178 lb 80.8 kg	3052OD.105.CRL-PC	Linen	10,655
		3052OD.105.CRW-PC	White	10,655

NOTE: American Standard Walk-in Baths cannot be combined with any other American Standard product orders and are not eligible for any rebates or other discount programs. For more information or to place orders please call: 1-866-423-0800 or fax: 888-872-3044

*Only available on Whirlpool and Combination Systems †Only available on Combination Systems

‡Only available on Air Spa and Combination Systems



- Premium gelcoat construction
- Patented Quick Drain® fast water removal system
- Warranty: lifetime on the door seal, 10-years on the tub shell, 5-years on components
- Outward opening door
- Water tight door system
- Built-in chair height seat
- Built-in polished chrome grab bar
- Textured tub floor
- Extension kit to fit 60" (1524 mm) space
- Freestanding metal support frame
- Polished chrome jets
- In-line water heater included*
- 6 Water jets*
- 21 Air jets†
- Legs-only massage
- Premium faucet with handheld shower in chrome included

Nominal Dimensions:

52 in x 32 in x 40 in (1320 mm x 812 mm x 1016 mm)

Description	Net Wt	SKU	Color	List Price
Gelcoat Value Series 32 x 52 -Inch Walk-in Tub With Soaker System - Left-Hand Drain With Faucet	150 lb 68.1 kg	3252OD.709.SLL-PC	Linen	8,215
		3252OD.709.SLW-PC	White	8,215
Gelcoat Value Series 32 x 52 -Inch Walk-in Tub With Soaker System - Right-Hand Drain With Faucet		3252OD.709.SRL-PC	Linen	8,215
		3252OD.709.SRW-PC	White	8,215
Gelcoat Value Series 32 x 52 -Inch Walk-in Tub With Whirlpool System - Left-Hand Drain With Faucet	174 lb 79.0 kg	3252OD.709.WLL-PC	Linen	9,595
		3252OD.709.WLW-PC	White	9,595
Gelcoat Value Series 32 x 52 -Inch Walk-in Tub With Whirlpool System - Right-Hand Drain With Faucet		3252OD.709.WRL-PC	Linen	9,595
		3252OD.709.WRW-PC	White	9,595
Gelcoat Value Series 32 x 52 -Inch Walk-in Tub With Air Spa System - Left-Hand Drain With Faucet	166 lb 75.4 kg	3252OD.709.ALL-PC	Linen	10,210
		3252OD.709.ALW-PC	White	10,210
Gelcoat Value Series 32 x 52 -Inch Walk-in Tub With Air Spa System - Right-Hand Drain With Faucet		3252OD.709.ARL-PC	Linen	10,210
		3252OD.709.ARW-PC	White	10,210
Gelcoat Value Series 32 x 52 -Inch Walk-in Tub With Combination Air Spa and Whirlpool Systems - Left-Hand Drain With Faucet	190 lb 86.3 kg	3252OD.709.CLL-PC	Linen	10,881
		3252OD.709.CLW-PC	White	10,881
Gelcoat Value Series 32 x 52 -Inch Walk-in Tub With Combination Air Spa and Whirlpool Systems - Right-Hand Drain With Faucet		3252OD.709.CRL-PC	Linen	10,881
		3252OD.709.CRW-PC	White	10,881

NOTE: American Standard Walk-in Baths cannot be combined with any other American Standard product orders and are not eligible for any rebates or other discount programs. For more information or to place orders please call: 1-866-423-0800 or fax: 888-872-3044

*Only available on Whirlpool and Combination Systems †Only available on Combination Systems

‡Only available on Air Spa and Combination Systems



- Premium gelcoat construction
- Patented Quick Drain® fast water removal system
- Warranty: lifetime on the door seal, 10-years on the tub shell, 5-years on components
- Outward opening door
- Water tight door system
- Built-in chair height seat
- Built-in polished chrome grab bar
- Textured tub floor
- Freestanding metal support frame
- Extension kit to fit 60" (1524 mm) space
- Polished chrome jets
- In-line water heater included*
- 6 Water jets*
- 21 Air jets†
- Legs-only massage
- Premium faucet with handheld shower in chrome included

Nominal Dimensions:

52 in x 30 in x 40 in (1320 mm x 762 mm x 1016 mm)

Description	Net Wt	SKU	Color	List Price
Gelcoat Value Series 30 x 52 -Inch Walk-in Tub With Soaker System - Left-Hand Drain With Faucet	138 lb 62.7 kg	3052OD.709.SLL-PC	Linen	7,516
		3052OD.709.SLW-PC	White	7,516
Gelcoat Value Series 30 x 52 -Inch Walk-in Tub With Soaker System - Right-Hand Drain With Faucet		3052OD.709.SRL-PC	Linen	7,516
		3052OD.709.SRW-PC	White	7,516
Gelcoat Value Series 30 x 52 -Inch Walk-in Tub With Whirlpool System - Left-Hand Drain With Faucet	162 lb 73.5 kg	3052OD.709.WLL-PC	Linen	8,896
		3052OD.709.WLW-PC	White	8,896
Gelcoat Value Series 30 x 52 -Inch Walk-in Tub With Whirlpool System - Right-Hand Drain With Faucet		3052OD.709.WRL-PC	Linen	8,896
		3052OD.709.WRW-PC	White	8,896
Gelcoat Value Series 30 x 52 -Inch Walk-in Tub With Air Spa System - Left-Hand Drain With Faucet	154 lb 69.9 kg	3052OD.709.ALL-PC	Linen	9,511
		3052OD.709.ALW-PC	White	9,511
Gelcoat Value Series 30 x 52 -Inch Walk-in Tub With Air Spa System - Right-Hand Drain With Faucet		3052OD.709.ARL-PC	Linen	9,511
		3052OD.709.ARW-PC	White	9,511
Gelcoat Value Series 30 x 52 -Inch Walk-in Tub With Combination Air Spa and Whirlpool Systems - Left-Hand Drain With Faucet	178 lb 80.8 kg	3052OD.709.CLL-PC	Linen	10,181
		3052OD.709.CLW-PC	White	10,181
Gelcoat Value Series 30 x 52 -Inch Walk-in Tub With Combination Air Spa and Whirlpool Systems - Right-Hand Drain With Faucet		3052OD.709.CRL-PC	Linen	10,181
		3052OD.709.CRW-PC	White	10,181

NOTE: American Standard Walk-in Baths cannot be combined with any other American Standard product orders and are not eligible for any rebates or other discount programs. For more information or to place orders please call: 1-866-423-0800 or fax: 888-872-3044

*Only available on Whirlpool and Combination Systems †Only available on Combination Systems

‡Only available on Air Spa and Combination Systems

Description	SKU #	Color/Finish	List Price
Chrome Fast-Fill Tub Filler With Shower Wand and Diverter 3/4-Inch (19 mm) Valves	9FHS-CH19	Polished Chrome	906
1000W In-line Whirlpool Heater	755931-201	N/A	350
AS Walk-In Tubs Neck Rest	9NR	Grey	65
Neck Rest With Grip for all Models Except 3252OD	9NRGRIP	Grey	69
Hand Shower Slide Bar System – Includes 24-Inch (610 mm) Grab Bar and Hand Shower Glide	9HSB	Polished Chrome	161
24-Inch (610 mm) Wall-Mounted Decorative Chrome Grab Bar	9GB-24	Polished Chrome	111
Acrylic Back Panel for 2848 • Must be factory installed	9BP-28L 9BP-28W	Linen White	385 385
Acrylic Back Panel for 3051 • Must be factory installed	9BP-30L 9BP-30W	Linen White	385 385
Acrylic Back Panel for 3260 • Must be factory installed	9BP-32L 9BP-32W	Linen White	385 385
Acrylic End Panel for 2848 on Faucet Side • Must be factory installed	9EP-28.FL 9EP-28.FW	Linen White	385 385
Acrylic End Panel for 2848 on Seat Side • Must be factory installed	9EP-28.SL 9EP-28.SW	Linen White	385 385
Acrylic End Panel for 3051 on Faucet Side • Must be factory installed	9EP-30.FL 9EP-30.FW	Linen White	385 385
Acrylic End Panel for 3051 on Seat Side • Must be factory installed	9EP-30.SL 9EP-30.SW	Linen White	385 385
Acrylic End Panel for 3260 on Faucet Side • Must be factory installed	9EP-32.FL 9EP-32.FW	Linen White	385 385
Acrylic End Panel for 3260 on Seat Side • Must be factory installed	9EP-32.SL 9EP-32.SW	Linen White	385 385



The American Standard seated shower fits in the space of a standard bathtub and features a built-in, chair-height seat perfect for anyone having difficulty standing in the shower.

Fully open on one side, the seat allows easy transfer in and out of the shower. In addition to the easy access 3" (76 mm) threshold, an innovative built-in wrap-around grab bar allows for safety and security anywhere in the shower.

The seated shower features durable and luxurious cast acrylic construction and is easy to install thanks to its freestanding metal frame with five adjustable leveling feet.



Acrylic 30 x 60-Inch Walk-In Shower – Left-Hand Drain

- One piece – highly durable and luxurious cast acrylic construction
- Factory installed on metal support frame
- Wide, full-sized, built-in contoured seat
- Allows for easy transfer into and out of the shower
- Wrap around grab bar system
- Integral tile flange
- Textured shower floor

Nominal Dimensions:

59-1/2 in x 30 in x 38-1/2 in (1511 mm x 762 mm x 977 mm)

Description	Net Wt	SKU	Color	List Price
Acrylic 30 x 60-Inch Walk-In Shower – Left-Hand Drain	160 lb 72.6 kg	3060SH.LW	White	3,241



Acrylic 30 x 60-Inch Walk-in Shower – Right-Hand Drain

- One piece – highly durable and luxurious cast acrylic construction
- Factory installed on metal support frame
- Wide, full-sized, built-in contoured seat
- Allows for easy transfer into and out of the shower
- Wrap around grab bar system
- Integral tile flange
- Textured shower floor

Nominal Dimensions:

59-1/2 in x 30 in x 38-1/2 in (1511 mm x 762 mm x 977 mm)

Description	Net Wt	SKU	Color	List Price
Acrylic 30 x 60-Inch Walk-in Shower – Right-Hand Drain	160 lb 72.6 kg	3060SH.RW	White	3,241

Independent, Safer and Comfortable Bathing

Fully equipped, the Safety Tubs® SSA Entry Series offers all the latest in safety and comfort features bundled together at one low cost and backed by a lifetime warranty on the door seal, a 10-year warranty on the tub shell and a 5-year warranty on all other components.

Available in full size 60" x 30" and two smaller sizes that include our tub extender kit allowing you to retrofit into various alcove sizes.

SSA Entry Series® Safety Tubs



Exclusive Innovations



Watertight Door System Technology

- Ergonomic, easy to use handle
- Lifetime warranty on seal

Features and Benefits

Soaker Bath

- Provides a warm relaxing soak

Jet Massage System

- 6 Massage jets
- Advanced back and leg therapy

Air Massage System

- 21 seat and floor Air Massage jets
- Soothing cascade of warm air bubbles

Dual System

- Combines the Jet Massage and Air Massage Systems



- Premium faucet and handheld showering wand
- Watertight Door System Technology ensures a water tight seal with a lifetime warranty
- Built-in 17" (432 mm) chair height seat
- Freestanding metal support frame – self leveling feet
- Built-in safety grab bar
- Tub extender kit is included with all tubs less than 60" (1524 mm) in length – use to retrofit into standard tub spaces
- Plumbing and fixture access panels
- Textured tub floor
- Low threshold

Nominal Dimensions:

59-1/2 in x 29-3/4 in x 37-1/2 in (1511 mm x 755 mm x 952 mm)

Description	Net Wt	SKU	Color	List Price
Gelcoat Entry Series 60 x 30-Inch Walk-In Tub With Soaker System – Left-Hand Drain With Faucet	140 lb 63.6 kg	SSA6030LS-BC	Biscuit	5,672
		SSA6030LS-WH	White	5,672
Gelcoat Entry Series 60 x 30-Inch Walk-In Tub With Soaker System – Right-Hand Drain With Faucet		SSA6030RS-BC	Biscuit	5,672
		SSA6030RS-WH	White	5,672
Gelcoat Entry Series 60 x 30-Inch Walk-In Tub With Whirlpool System – Left-Hand Drain With Faucet	156 lb 70.8 kg	SSA6030LJ-BC	Biscuit	6,309
		SSA6030LJ-WH	White	6,309
Gelcoat Entry Series 60 x 30-Inch Walk-In Tub With Whirlpool System – Right-Hand Drain With Faucet	166 lb 75.4 kg	SSA6030RJ-BC	Biscuit	6,309
		SSA6030RJ-WH	White	6,309
Gelcoat Entry Series 60 x 30-Inch Walk-In Tub With Air Spa System – Left-Hand Drain With Faucet	154 lb 69.9 kg	SSA6030LA-BC	Biscuit	6,584
		SSA6030LA-WH	White	6,584
Gelcoat Entry Series 60 x 30-Inch Walk-In Tub With Air Spa System – Right-Hand Drain With Faucet		SSA6030RA-BC	Biscuit	6,584
		SSA6030RA-WH	White	6,584
Gelcoat Entry Series 60 x 30-Inch Walk-In Tub With Combination Air Spa and Whirlpool Systems – Left-Hand Drain With Faucet	180 lb 81.7 kg	SSA6030LD-BC	Biscuit	7,316
		SSA6030LD-WH	White	7,316
Gelcoat Entry Series 60 x 30-Inch Walk-In Tub With Combination Air Spa and Whirlpool Systems – Right-Hand Drain With Faucet		SSA6030RD-BC	Biscuit	7,316
		SSA6030RD-WH	White	7,316



- Premium faucet and handheld showering wand
- Watertight Door System Technology ensures a water tight seal with a lifetime warranty
- Built-in 17" (432 mm) chair height seat
- Freestanding metal support frame – self leveling feet
- Built-in safety grab bar
- Tub extender kit is included with all tubs less than 60" (1524 mm) in length – use to retrofit into standard tub spaces
- Plumbing and fixture access panels
- Textured tub floor
- Low threshold

Nominal Dimensions:

51-1/2 in x 29-3/4 in x 42 in (1308 mm x 755 mm x 1066 mm)

Description	Net Wt	SKU	Color	List Price
Gelcoat Entry Series 52 x 30-Inch Walk-In Tub With Soaker System – Left-Hand Drain With Faucet	138 lb 62.7 kg	SSA5230LS-BC	Biscuit	5,722
		SSA5230LS-WH	White	5,722
Gelcoat Entry Series 52 x 30-Inch Walk-In Tub With Soaker System – Right-Hand Drain With Faucet		SSA5230RS-BC	Biscuit	5,722
		SSA5230RS-WH	White	5,722
Gelcoat Entry Series 52 x 30-Inch Walk-In Tub With Whirlpool System – Left-Hand Drain With Faucet	162 lb 73.5 kg	SSA5230LJ-BC	Biscuit	6,360
		SSA5230LJ-WH	White	6,360
Gelcoat Entry Series 52 x 30-Inch Walk-In Tub With Whirlpool System – Right-Hand Drain With Faucet		SSA5230RJ-BC	Biscuit	6,360
		SSA5230RJ-WH	White	6,360
Gelcoat Entry Series 52 x 30-Inch Walk-In Tub With Air Spa System – Left-Hand Drain With Faucet	154 lb 69.9 kg	SSA5230LA-BC	Biscuit	6,544
		SSA5230LA-WH	White	6,544
Gelcoat Entry Series 52 x 30-Inch Walk-In Tub With Air Spa System – Right-Hand Drain With Faucet		SSA5230RA-BC	Biscuit	6,544
		SSA5230RA-WH	White	6,544
Gelcoat Entry Series 52 x 30-Inch Walk-In Tub With Combination Air Spa and Whirlpool Systems – Left-Hand Drain With Faucet	178 lb 80.8 kg	SSA5230LD-BC	Biscuit	7,274
		SSA5230LD-WH	White	7,274
Gelcoat Entry Series 52 x 30-Inch Walk-In Tub With Combination Air Spa and Whirlpool Systems – Right-Hand Drain With Faucet		SSA5230RD-BC	Biscuit	7,274
		SSA5230RD-WH	White	7,274



- Premium faucet and handheld showering wand
- Watertight Door System Technology ensures a water tight seal with a lifetime warranty
- Built-in 17" (432 mm) chair height seat
- Freestanding metal support frame – self leveling feet
- Built-in safety grab bar
- Tub extender kit is included with all tubs less than 60" (1524 mm) in length – use to retrofit into standard tub spaces
- Plumbing and fixture access panels
- Textured tub floor
- Low threshold

Nominal Dimensions:

48 in x 28-1/2 in x 37-1/2 in (1219 mm x 723 mm x 952 mm)

Description	Net Wt	SKU	Color	List Price
Gelcoat Entry Series 48 x 28-Inch Walk-In Tub With Soaker System – Left-Hand Drain With Faucet	152 lb 69.0 kg	SSA4828LS-BC	Biscuit	4,849
		SSA4828LS-WH	White	4,849
Gelcoat Entry Series 48 x 28-Inch Walk-In Tub With Soaker System – Right-Hand Drain With Faucet	152 lb 69.0 kg	SSA4828RS-BC	Biscuit	4,849
		SSA4828RS-WH	White	4,849
Gelcoat Entry Series 48 x 28-Inch Walk-In Tub With Whirlpool System – Left-Hand Drain With Faucet	165 lb 74.9 kg	SSA4828LJ-BC	Biscuit	5,486
		SSA4828LJ-WH	White	5,486
Gelcoat Entry Series 48 x 28-Inch Walk-In Tub With Whirlpool System – Right-Hand Drain With Faucet	165 lb 74.9 kg	SSA4828RJ-BC	Biscuit	5,486
		SSA4828RJ-WH	White	5,486
Gelcoat Entry Series 48 x 28-Inch Walk-In Tub With Air Spa System – Left-Hand Drain With Faucet	154 lb 69.9 kg	SSA4828LA-BC	Biscuit	5,852
		SSA4828LA-WH	White	5,852
Gelcoat Entry Series 48 x 28-Inch Walk-In Tub With Air Spa System – Right-Hand Drain With Faucet	154 lb 69.9 kg	SSA4828RA-BC	Biscuit	5,852
		SSA4828RA-WH	White	5,852
Gelcoat Entry Series 48 x 28-Inch Walk-In Tub With Combination Air Spa and Whirlpool Systems – Left-Hand Drain With Faucet	152 lb 69.0 kg	SSA4828LD-BC	Biscuit	6,401
		SSA4828LD-WH	White	6,401
Gelcoat Entry Series 48 x 28-Inch Walk-In Tub With Combination Air Spa and Whirlpool Systems – Right-Hand Drain With Faucet	152 lb 69.0 kg	SSA4828RD-BC	Biscuit	6,401
		SSA4828RD-WH	White	6,401

Indulge in Luxury and Style

Indulge in the luxury of one of American Standard's freestanding bathtubs with styles ranging from traditional, casual, to modern. American Standard freestanding bathtubs provide a roomy bathing space but are compact enough to comfortably fit in the average-sized bathroom. Designed to create an elegant and luxurious bathroom focal point, American Standard freestanding bathtubs are the perfect option for your new home or bathroom remodel.

Freestanding bathtubs from American Standard are available with and without a bathtub filler faucet, built to last, with high-gloss, acrylic reinforced with fiberglass construction for a scratch-resistant shine and lasting durability.

Studio® S Freestanding Bathtub



Freestanding Bathtubs Overview

Studio® S



Sedona® Loft®



Town Square® S



Cadet® With Tub Filler



Townsend®



Cadet®



Coastal™ Serin™





Cadet® 66 x 32-Inch Freestanding Bathtub With Drain Chrome Finish

- High-quality acrylic with fiberglass reinforcement
- Easy-to-clean high-gloss surface that's UV stable and stain resistant
- Drain off center
- Polished Chrome drain and overflow cover included
- Limited lifetime warranty

Nominal Dimensions:

66 in x 32 in x 23 in (1676 mm x 812 mm x 584 mm)



Description	Net Wt	SKU	Color	List Price
Cadet® 66 x 32-Inch Freestanding Bathtub With Drain Chrome Finish	101 lb 46.3 kg	2764014.011	Arctic	2,309

Separate Components:

Access Panel	0 lb 0.3 kg	▷754766-200.0110A	Arctic	156
--------------	----------------	-------------------	--------	-----



Cadet® 66 x 32-Inch Freestanding Bathtub With Drain Brushed Nickel Finish

- High-quality acrylic with fiberglass reinforcement
- Easy-to-clean high-gloss surface that's UV stable and stain resistant
- Drain off center
- Brushed Nickel drain and overflow cover included
- Limited lifetime warranty

Nominal Dimensions:

66 in x 32 in x 23 in (1676 mm x 812 mm x 584 mm)



Description	Net Wt	SKU	Color	List Price
Cadet® 66 x 32-Inch Freestanding Bathtub With Drain Brushed Nickel Finish	101 lb 46.3 kg	2764014M204.011	Arctic	2,349

Separate Components:

Access Panel	0 lb 0.3 kg	▷754766-200.0110A	Arctic	156
--------------	----------------	-------------------	--------	-----



Cadet® 66 x 32-Inch Freestanding Bathtub With Polished Chrome Finish Filler and Drain Kit

- High-quality acrylic with fiberglass reinforcement
- Easy-to-clean high-gloss surface that's UV stable and stain resistant
- Drain off center
- Polished Chrome drain and overflow cover included
- Polished Chrome bathtub filler and handheld shower included
- Limited lifetime warranty

Nominal Dimensions:

66 in x 32 in x 30-5/8 in (1676 mm x 812 mm x 777 mm)



Description	Net Wt	SKU	Color	List Price
Cadet® 66 x 32-Inch Freestanding Bathtub With Polished Chrome Finish Filler and Drain Kit	119 lb 54.3 kg	2764014M202.011	Arctic	2,910

Separate Components:

Access Panel	0 lb 0.3 kg	▷754766-200.0110A	Arctic	156
--------------	----------------	-------------------	--------	-----

▷ Parts Program (Non-Premier)



Cadet® 66 x 32-Inch Freestanding Bathtub With Brushed Nickel Finish Filler and Drain Kit

- High-quality acrylic with fiberglass reinforcement
- Easy-to-clean high-gloss surface that's UV stable and stain resistant
- Drain off center
- Brushed Nickel drain and overflow cover included
- Brushed Nickel bathtub filler and handheld shower included
- Limited lifetime warranty

Nominal Dimensions:

66 in x 32 in x 23 in (1676 mm x 812 mm x 584 mm)



Description	Net Wt	SKU	Color	List Price
Cadet® 66 x 32-Inch Freestanding Bathtub With Brushed Nickel Finish Filler and Drain Kit	119 lb 54.3 kg	2764014M203.011	Arctic	3,137

Separate Components:

Access Panel	0 lb 0.3 kg	▷754766-200.0110A	Arctic	156
--------------	----------------	-------------------	--------	-----



Coastal™ Serin™ 68 x 31-Inch Freestanding Bathtub Center Drain With Integrated Overflow

- High-quality seamless acrylic one-piece construction with fiberglass reinforcement
- Easy-to-clean high-gloss surface that's UV stable and stain resistant
- Center drain with integrated overflow
- Removable polished chrome overflow cover and toe-tap drain included
- Steel structural support frame with adjustable leveling feet for easy installation
- Limited lifetime warranty

Nominal Dimensions:

68-3/4 in x 31-1/4 in x 23-5/8 in (1746 mm x 793 mm x 600 mm)



Description	Net Wt	SKU	Color	List Price
Coastal™ Serin™ 68 x 31-Inch Freestanding Bathtub Center Drain With Integrated Overflow	104 lb 47.2 kg	2765034.020	White	3,490

Required Components:

* Freestanding Bathtub Overflow Cover and Drain Kit	1 lb 0.5 kg	1680100.243	Matte Black	256
		1680100.002	Polished Chrome	128
		1680100.013	Polished Nickel	141
		1680100.278	Legacy Bronze	149
		1680100.295	Brushed Nickel	143

▷ Parts Program (Non-Premier)

* Non-Premier Product



Sedona® Loft® 63 x 30-Inch Rectangle Freestanding Bathtub Center Drain With Integrated Overflow

- High-quality seamless acrylic one-piece construction with fiberglass reinforcement
- Easy-to-clean high-gloss surface that's UV stable and stain resistant
- Center drain with integrated overflow
- Removable Polished Chrome overflow cover and toe-tap drain included
- Steel structural support frame with adjustable leveling feet for easy installation
- Limited lifetime warranty

Nominal Dimensions:

62-3/4 in x 29-7/8 in x 22-7/8 in (1593 mm x 758 mm x 581 mm)



Description	Net Wt	SKU	Color	List Price
Sedona® Loft® 63 x 30-Inch Rectangle Freestanding Bathtub Center Drain With Integrated Overflow	111 lb 50.4 kg	2766034.020	White	3,379

Required Components:

* Freestanding Bathtub Overflow Cover and Drain Kit	1 lb 0.5 kg	1680100.243	Matte Black	256
		1680100.002	Polished Chrome	128
		1680100.013	Polished Nickel	141
		1680100.278	Legacy Bronze	149
		1680100.295	Brushed Nickel	143



Studio® S 68 x 34-Inch Freestanding Bathtub Center Drain With Integrated Overflow

- High-quality seamless acrylic one-piece construction with fiberglass reinforcement
- Easy-to-clean high-gloss surface that's UV stable and stain resistant
- Center drain with integrated overflow
- Steel structural support frame with adjustable leveling feet for easy installation
- Limited lifetime warranty

Nominal Dimensions:

68 in x 34 in x 24-1/2 in (1727 mm x 863 mm x 622 mm)



Description	Net Wt	SKU	Color	List Price
Studio® S 68 x 34-Inch Freestanding Bathtub Center Drain With Integrated Overflow	145 lb 65.9 kg	2549004.020	White	3,635

Required Components:

Studio® S Freestanding Bathtub Drain Kit	1 lb 0.6 kg	1582200.002	Polished Chrome	140
		1582200.295	Brushed Nickel	210
		1582200.243	Matte Black	265

▷ Parts Program (Non-Premier)

* Non-Premier Product



Town Square® S 68 x 36-Inch Freestanding Bathtub Center Drain With Integrated Overflow

- Straight back wall allows for optional "flush-to-the-wall" installation, leaving no space to trap dust or debris
- High-quality seamless acrylic one-piece construction with fiberglass reinforcement
- Easy-to-clean high-gloss surface that's UV stable and stain resistant
- Center drain with integrated overflow
- Wide deck can accommodate a bathtub faucet or store toiletries
- Steel structural support frame with adjustable leveling feet for easy installation
- Removable access panel on back of tub
- Limited lifetime warranty

Nominal Dimensions:

68 in x 36 in x 24-7/16 in (1727 mm x 914 mm x 620 mm)



Description	Net Wt	SKU	Color	List Price
Town Square® S 68 x 36-Inch Freestanding Bathtub Center Drain With Integrated Overflow	150 lb 68.1 kg	2546004.020	White	3,742

Separate Components:

Access Panel	2 lb 1.0 kg	▷755495-201.0200A	White	150
--------------	----------------	-------------------	-------	-----

Required Components:

* Town Square® S Freestanding Bathtub Overflow Cover and Drain Kit	1 lb 0.8 kg	1614305.002	Polished Chrome	185
		1614305.013	Polished Nickel	260
		1614305.278	Legacy Bronze	278
		1614305.295	Brushed Nickel	260



Townsend® 68 x 36-Inch Freestanding Bathtub Center Drain With Integrated Overflow

- Straight back wall allows for optional "flush-to-the-wall" installation, leaving no space to trap dust or debris
- High-quality seamless acrylic one-piece construction with fiberglass reinforcement
- Easy-to-clean high-gloss surface that's UV stable and stain resistant
- Center drain with integrated overflow
- Wide deck can accommodate a bathtub faucet or store toiletries
- Steel structural support frame with adjustable leveling feet for easy installation
- Removable access panel on back of bathtub
- Limited lifetime warranty

Nominal Dimensions:

68 in x 35-5/8 in x 24-1/4 in (1727 mm x 904 mm x 615 mm)



Description	Net Wt	SKU	Color	List Price
Townsend® 68 x 36-Inch Freestanding Bathtub Center Drain With Integrated Overflow	143 lb 64.9 kg	2691004.020	White	3,553





Required Components:

* Townsend® Freestanding Bathtub Overflow Cover and Drain Kit	1 lb 0.8 kg	1582000.243	Matte Black	256
		1582000.002	Polished Chrome	143
		1582000.013	Polished Nickel	202
		1582000.278	Legacy Bronze	202
		1582000.295	Brushed Nickel	216

▷ Parts Program (Non-Premier)

* Non-Premier Product

	Description	SKU #	Color/Finish	List Price
	Bathtub Drain	1583470.002	Polished Chrome	198
	<ul style="list-style-type: none"> • Universal design works with American Standard baths and spa tubs 	1583470.011	Arctic	338
	<ul style="list-style-type: none"> • Brass construction withstands prolonged contact with water 	1583470.020	White	338
	<ul style="list-style-type: none"> • Rotary knob makes it easy to operate stopper 	1583470.295	Brushed Nickel	338
	<ul style="list-style-type: none"> • Powder-coated stopper and overflow cap for durability • Available in multiple finishes to match décor • One-year limited warranty 			
	Deep Soak® Bathtub Drain	1640305.002	Polished Chrome	174
	<ul style="list-style-type: none"> • Overflow feature provides more than 2" (56 mm) of additional water depth for deeper soaking 	1640305.011	Arctic	234
	<ul style="list-style-type: none"> • Pop-up drain requires gentle push to open and close 	1640305.020	White	195
	<ul style="list-style-type: none"> • Sleek escutcheon adds a finishing touch to overflow opening 	1640305.021	Bone	193
	<ul style="list-style-type: none"> • Made of quality materials for durability • Easy to install • Available in beautiful finishes to coordinate with décor • One-year limited warranty 	1640305.222	Linen	234
		1640305.295	Brushed Nickel	312
	Deep Soak® Max Bathtub Drain	1599205.002	Polished Chrome	195
	<ul style="list-style-type: none"> • Unique top-mount overflow allows 3" (76 mm) deeper water level than standard bath drain 	1599205.011	Arctic	234
	<ul style="list-style-type: none"> • Tap-actuated pop-up drain stopper 	1599205.020	White	195
	<ul style="list-style-type: none"> • Solid brass construction for durability 	1599205.295	Brushed Nickel	312
	<ul style="list-style-type: none"> • Available in multiple finishes to match décor • Works with Evolution® Series tubs • One-year limited warranty 			
	Freestanding Bathtub Overflow Cover and Drain Kit	1680100.002	Polished Chrome	128
	<ul style="list-style-type: none"> • Pop-up drain requires gentle push to open and close 	1680100.013	Polished Nickel	141
	<ul style="list-style-type: none"> • Sleek escutcheon adds a finishing touch to overflow opening 	1680100.243	Matte Black	256
	<ul style="list-style-type: none"> • Standard overflow cover and drain 	1680100.278	Legacy Bronze	149
	<ul style="list-style-type: none"> • Fits American Standard freestanding bathtub models 2765.034, 2766.034 and 2767.034 • Available in finishes to complement bathroom décor • One-year limited warranty 	1680100.295	Brushed Nickel	143
	Studio® S Freestanding Bathtub Drain Kit	1582200.002	Polished Chrome	140
	<ul style="list-style-type: none"> • Pop-up drain requires gentle push to open and close 	1582200.243	Matte Black	265
	<ul style="list-style-type: none"> • Made of quality materials for durability • Easy to install • Designed for use with American Standard Studio® S freestanding bathtub model 2549.004 • Available in beautiful finishes to coordinate with décor • One-year limited warranty 	1582200.295	Brushed Nickel	210

	Description	SKU #	Color/Finish	List Price
	Townsend® Freestanding Bathtub Overflow Cover and Drain Kit <ul style="list-style-type: none"> • Pop-up drain requires gentle push to open and close • Sleek escutcheon adds a finishing touch to overflow opening • Made of quality materials for durability • Easy to install • Designed for use with American Standard Townsend® freestanding bathtub model 2691.004 • Available in beautiful finishes to coordinate with décor • One-year limited warranty 	1582000.002	Polished Chrome	143
		1582000.013	Polished Nickel	202
		1582000.243	Matte Black	256
		1582000.278	Legacy Bronze	202
		1582000.295	Brushed Nickel	216
	Town Square® S Freestanding Bathtub Overflow Cover and Drain Kit  <ul style="list-style-type: none"> • Pop-up drain requires gentle push to open and close • Sleek escutcheon adds a finishing touch to overflow opening • Made of quality materials for durability • Easy to install • Designed for use with American Standard Town Square® S freestanding bathtub model 2546.004 • Available in beautiful finishes to coordinate with décor • One-year limited warranty 	1614305.002	Polished Chrome	185
		1614305.013	Polished Nickel	260
		1614305.278	Legacy Bronze	278
		1614305.295	Brushed Nickel	260
	Safe-T Heater <ul style="list-style-type: none"> • Quick connect Safe-T Heater connection system - whirlpool only • Helps maintain a consistent water temperature • Easy to install • Designed for use with American Standard whirlpool bathtubs • 1500 watt and includes overheat protection • One-year limited warranty 	9075120	No Finish	393
	Universal Tile Bead Adhesive (Bulk) <ul style="list-style-type: none"> • Acts as a water retention flange • Drop-in tub accessory for 3 wall alcove applications • Includes 30' (9.1 m) roll of adhesive ONLY • Easy to install • Does not include tile bead, must be purchased seperately • One-year limited warranty 	9330014		52
	Universal Tile Bead Kit <ul style="list-style-type: none"> • Acts as a water retention flange • Drop-in tub accessory for 3 wall alcove applications • Includes 15' (4.6 m) roll of tile bead • Includes 15' (4.6 m) roll of adhesive • Easy to install • One-year limited warranty 	751755-100	White	79

Bathtubs

Bathtubs Overview

Soakers



Cadet®



Evolution®



Studio®



Studio®



Town Square® S

Whirlpools



Cadet®



Evolution®



Evolution®



Evolution®

Air Baths

Combination Spas

Images for illustrative purposes only – actual features may vary.

Whirlpools, air baths and combo massage systems from American Standard® offer massage therapy options to satisfy any need, whether it's renewing aching muscles or soothing away the tensions of a hectic day. Available in a range of styles, sizes and shapes, it's easy to find the perfect model to complement any bathroom design.



■ **EverClean® Whirlpool System** Fully adjustable, high-efficiency jets produce a strong stream, leaving the bather feeling refreshed and energized. Select models also feature jets in the lumbar region to provide a soothing shiatsu massage.

■ **EverClean Air Bath System**

Thousands of warm air bubbles produced from air jets that sit perfectly flush with the inside perimeter of the tub create a calm and gentle or brisk and invigorating experience.

■ **Standard Whirlpools**

Standard whirlpools feature single speed motors with durable, air-activated on/off switches.

All models also feature silent air controls that allow precise control of jet force levels.

To ensure reliability, all pumps offer dry-run seal protection that keep them safe if accidentally run without water.

■ **EverClean Whirlpools**

EverClean whirlpools offer all the benefits of our Standard Whirlpools, plus the EverClean System, a unique feature you'll only find at American Standard. American Standard whirlpools with Everclean® incorporate a patented silver-ion additive right into the circulation piping to protect the pipes from mold, mildew, algae and fungus that could cause deterioration or staining of the pipes.

 **EverClean® System**

American Standard whirlpools with Everclean® incorporate a patented silver-ion additive right into the circulation piping to protect the pipes from mold, mildew, algae and fungus that could cause deterioration or staining of the pipes.

The EverClean System, exclusively from American Standard, is the easiest way to help keep your whirlpool and air bath circulation system clean.

- The silver-ion additive is molded directly into the circulation piping
- The silver-ion additive protects the pipes from algae, fungus, mold and mildew
- The silver-ion additive works around the clock no matter how often you use your whirlpool or air bath
- Competitive cleaning systems using ozone that operate only while the motor is running will not help when water gets into the jets or piping during bathing or showering

The silver-ion additive is molded right into the circulating piping.

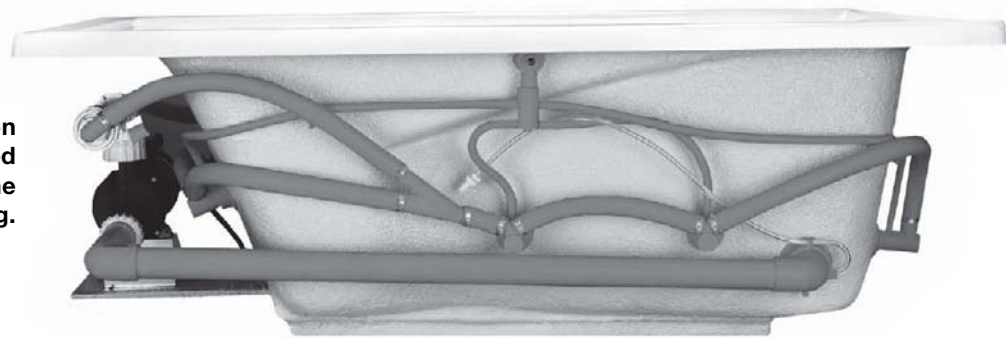

Whirlpools and Air Baths

American Standard whirlpools can be customized to fit your preferences. Choose a whirlpool with flat-mounted **Clean Jets™** or the relaxing, soothing bubbles of an **Air Bath**. Two great ways to indulge.

Whirlpools

- Clean Jets are multi-directional, adding greater flexibility and comfort to each individual bather, and the smooth, easy-to-clean surfaces ensure they look great for the life of the product
- From a gentle, relaxing swirl to a more vigorous deep-tissue massage, you can select the intensity that is right for you
- Strategically positioned for every body type

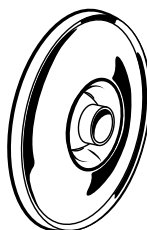

Clean Jets are flat mounted for a smooth, easy to clean surface

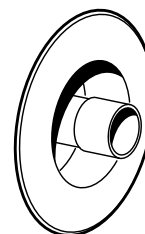

Ordinary whirlpool jets

Air Baths

- Designed to excite the skin and soothe the mind, Evolution® Air Baths will envelop you in a cascade of warm, comforting bubbles
- Full body massage from air jets placed strategically around the bath wall
- Variable speeds to adjust the experience from gentle to invigorating and anywhere in between

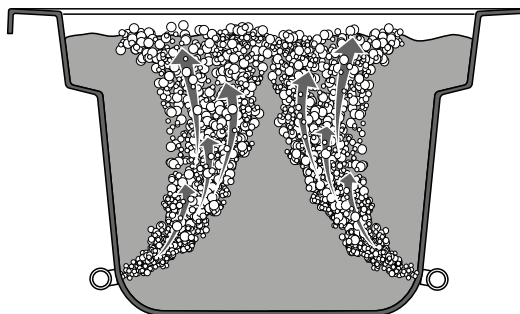

Deep Soak® Max Bath Drain

- Deep Soak tubs are specially designed to work with our Deep Soak max bath drain
- Provides 3" (76 mm) of additional water depth for a more luxurious soaking experience
- Low step-over height so it is easy to get in and out

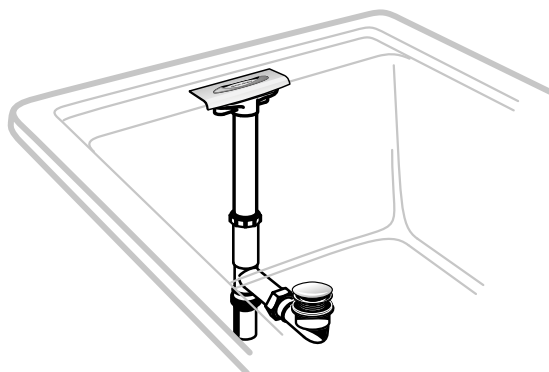



Cadet® 60 x 42-Inch Drop-In Bathtub

- Transitional style soaking tub
- Molded-in armrests with elbow supports and back lumbar support
- High-quality acrylic with fiberglass reinforcement
- Easy-to-clean high-gloss surface that's UV stable and stain resistant
- Pre-leveled tub bottom for easier installation
- 2-year warranty

Nominal Dimensions:

60 in x 42 in x 19-3/4 in (1524 mm x 1066 mm x 501 mm)



Description	Net Wt	SKU	Color	List Price
Cadet® 60 x 42-Inch Drop-In Bathtub	72 lb 32.7 kg	2772002.020	White	1,179

Required Components:

Bathtub Drain	6 lb 3.1 kg	1583470.002	Polished Chrome	198
		1583470.020	White	338
		1583470.295	Brushed Nickel	338
Deep Soak® Bathtub Drain	2 lb 1.0 kg	1640305.002	Polished Chrome	174
		1640305.020	White	195
		1640305.295	Brushed Nickel	312

Optional Components:

Universal Tile Bead Kit	2 lb 1.0 kg	751755-100	White	79
Universal Tile Bead Adhesive (Bulk)	21 lb 9.5 kg	9330014		52



Cadet® 72 x 42-Inch Drop-In Bathtub

- Transitional style soaking tub
- Molded-in armrests with elbow supports and back lumbar support
- High-quality acrylic with fiberglass reinforcement
- Easy-to-clean high-gloss surface that's UV stable and stain resistant
- Pre-leveled tub bottom for easier installation
- 2-year warranty

Nominal Dimensions:

72 in x 42 in x 19-3/4 in (1828 mm x 1066 mm x 501 mm)



Description	Net Wt	SKU	Color	List Price
Cadet® 72 x 42-Inch Drop-In Bathtub	83 lb 37.7 kg	2774002.020	White	1,261

Required Components:

Bathtub Drain	6 lb 3.1 kg	1583470.002	Polished Chrome	198
		1583470.020	White	338
		1583470.295	Brushed Nickel	338
Deep Soak® Bathtub Drain	2 lb 1.0 kg	1640305.002	Polished Chrome	174
		1640305.020	White	195
		1640305.295	Brushed Nickel	312

Optional Components:

Universal Tile Bead Kit	2 lb 1.0 kg	751755-100	White	79
Universal Tile Bead Adhesive (Bulk)	21 lb 9.5 kg	9330014		52



Evolution® 60 x 32-Inch Deep Soak® Integral Apron Bathtub

- Transitional style soaking tub
- High-quality acrylic with fiberglass reinforcement
- Easy-to-clean high-gloss surface that's UV stable and stain resistant
- Integral 3-sided tile/water retention flange
- Integral apron with removable access panel
- Dual molded-in armrests
- Must order Deep Soak® Max Drain
- Limited lifetime warranty

Nominal Dimensions:

60 in x 32 in x 21-1/2 in (1524 mm x 812 mm x 546 mm)



Description	Net Wt	SKU	Color	List Price
Evolution® 60 x 32-Inch Deep Soak® Integral Apron Bathtub	75 lb	2425V-RHO002.011	Arctic	1,161
	34.0 kg	2425V-RHO002.020	White	1,161

Required Components:

Deep Soak® Max Bathtub Drain	6 lb 2.7 kg	1599205.002	Polished Chrome	195
		1599205.011	Arctic	234
		1599205.020	White	195
		1599205.295	Brushed Nickel	312



Evolution® 60 x 32-Inch Deep Soak® Integral Apron Bathtub

- Transitional style soaking tub
- High-quality acrylic with fiberglass reinforcement
- Easy-to-clean high-gloss surface that's UV stable and stain resistant
- Integral 3-sided tile/water retention flange
- Integral apron with removable access panel
- Dual molded-in armrests
- Must order Deep Soak® Max Drain
- Limited lifetime warranty

Nominal Dimensions:

60 in x 32 in x 21-1/2 in (1524 mm x 812 mm x 546 mm)



Description	Net Wt	SKU	Color	List Price
Evolution® 60 x 32-Inch Deep Soak® Integral Apron Bathtub	75 lb	2425V-LHO002.011	Arctic	1,161
	34.0 kg	2425V-LHO002.020	White	1,161

Required Components:

Deep Soak® Max Bathtub Drain	6 lb 2.7 kg	1599205.002	Polished Chrome	195
		1599205.011	Arctic	234
		1599205.020	White	195
		1599205.295	Brushed Nickel	312



Evolution® 60 x 32-Inch Deep Soak® Drop-In Bathtub

- Transitional style soaking tub
- High-quality acrylic with fiberglass reinforcement
- Easy-to-clean high-gloss surface that's UV stable and stain resistant
- Dual molded-in armrests
- Pre-leveled tub bottom for easier installation
- Drop-in or undermount option
- Must order Deep Soak® Max Drain
- Limited lifetime warranty

Nominal Dimensions:

60 in x 32 in x 21-1/2 in (1524 mm x 812 mm x 546 mm)



Description	Net Wt	SKU	Color	List Price
Evolution® 60 x 32-Inch Deep Soak® Drop-In Bathtub	73 lb	2422V002.011	Arctic	1,137
	33.1 kg	2422V002.020	White	1,137

Required Components:

Deep Soak® Max Bathtub Drain	6 lb 2.7 kg	1599205.002	Polished Chrome	195
		1599205.011	Arctic	234
		1599205.020	White	195
		1599205.295	Brushed Nickel	312

Optional Components:

Universal Tile Bead Kit	2 lb 1.0 kg	751755-100	White	79
Universal Tile Bead Adhesive (Bulk)	21 lb 9.5 kg	9330014		52



Evolution® 60 x 36-Inch Deep Soak® Drop-In Bathtub

- Transitional style soaking tub
- High-quality acrylic with fiberglass reinforcement
- Easy-to-clean high-gloss surface that's UV stable and stain resistant
- Dual molded-in armrests
- Pre-leveled tub bottom for easier installation
- Drop-in or undermount option
- Must order Deep Soak® Max Drain
- Limited lifetime warranty

Nominal Dimensions:

60 in x 36 in x 21-1/2 in (1524 mm x 914 mm x 546 mm)



Description	Net Wt	SKU	Color	List Price
Evolution® 60 x 36-Inch Deep Soak® Drop-In Bathtub	76 lb	2771V002.011	Arctic	1,187
	34.5 kg	2771V002.020	White	1,187

Required Components:

Deep Soak® Max Bathtub Drain	6 lb 2.7 kg	1599205.002	Polished Chrome	195
		1599205.011	Arctic	234
		1599205.020	White	195
		1599205.295	Brushed Nickel	312

Optional Components:

Universal Tile Bead Kit	2 lb 1.0 kg	751755-100	White	79
Universal Tile Bead Adhesive (Bulk)	21 lb 9.5 kg	9330014		52



Evolution® 72 x 36-Inch Deep Soak® Drop-In Bathtub

- Transitional style soaking tub
- High-quality acrylic with fiberglass reinforcement
- Easy-to-clean high-gloss surface that's UV stable and stain resistant
- Dual molded-in armrests
- Pre-leveled tub bottom for easier installation
- Drop-in or undermount option
- Must order Deep Soak® Max Drain
- Limited lifetime warranty

Nominal Dimensions:

72 in x 36 in x 21-1/2 in (1828 mm x 914 mm x 546 mm)



Description	Net Wt	SKU	Color	List Price
Evolution® 72 x 36-Inch Deep Soak® Drop-In Bathtub	58 lb	7236V002.011	Arctic	1,348
	26.3 kg	7236V002.020	White	1,348

Required Components:

Deep Soak® Max Bathtub Drain	6 lb 2.7 kg	1599205.002	Polished Chrome	195
		1599205.011	Arctic	234
		1599205.020	White	195
		1599205.295	Brushed Nickel	312

Optional Components:

Universal Tile Bead Kit	2 lb 1.0 kg	751755-100	White	79
Universal Tile Bead Adhesive (Bulk)	21 lb 9.5 kg	9330014		52



Studio® 60 x 30-Inch Integral Apron Bathtub With Right-Hand Outlet

- Minimalist design with contoured lumbar support
- High-quality acrylic with fiberglass reinforcement
- Easy-to-clean high-gloss surface that's UV stable and stain resistant
- Integral 3-sided tile/water retention flange
- Integral apron for recess application
- Pre-leveled tub bottom for easier installation
- ADA compliant
- Limited lifetime warranty

Nominal Dimensions:

60 in x 30 in x 19 in (1524 mm x 762 mm x 482 mm)



Description	Net Wt	SKU	Color	List Price
Studio® 60 x 30-Inch Integral Apron Bathtub With Right-Hand Outlet	50 lb 22.7 kg	2973102.011	Arctic	1,029
		2973102.020	White	1,029

Required Components:

Bathtub Drain	6 lb 3.1 kg	1583470.002	Polished Chrome	198
		1583470.011	Arctic	338
		1583470.020	White	338
		1583470.295	Brushed Nickel	338
Deep Soak® Bathtub Drain	2 lb 1.0 kg	1640305.002	Polished Chrome	174
		1640305.011	Arctic	234
		1640305.020	White	195
		1640305.295	Brushed Nickel	312



Studio® 60 x 30-Inch Integral Apron Bathtub With Left-Hand Outlet

- Minimalist design with contoured lumbar support
- High-quality acrylic with fiberglass reinforcement
- Easy-to-clean high-gloss surface that's UV stable and stain resistant
- Integral 3-sided tile/water retention flange
- Integral apron for recess application
- Pre-leveled tub bottom for easier installation
- ADA compliant
- Limited lifetime warranty

Nominal Dimensions:

60 in x 30 in x 19 in (1524 mm x 762 mm x 482 mm)



Description	Net Wt	SKU	Color	List Price
Studio® 60 x 30-Inch Integral Apron Bathtub With Left-Hand Outlet	50 lb	2973202.011	Arctic	1,029
	22.7 kg	2973202.020	White	1,029

Required Components:

Bathtub Drain	6 lb 3.1 kg	1583470.002	Polished Chrome	198
		1583470.011	Arctic	338
		1583470.020	White	338
		1583470.295	Brushed Nickel	338
Deep Soak® Bathtub Drain	2 lb 1.0 kg	1640305.002	Polished Chrome	174
		1640305.011	Arctic	234
		1640305.020	White	195
		1640305.295	Brushed Nickel	312



Studio® 60 x 32-Inch Integral Apron Bathtub With Right-Hand Outlet

- Minimalist design with contoured lumbar support
- High-quality acrylic with fiberglass reinforcement
- Easy-to-clean high-gloss surface that's UV stable and stain resistant
- Integral 3-sided tile/water retention flange
- Integral apron for recess application
- Pre-leveled tub bottom for easier installation
- ADA compliant
- Limited lifetime warranty
- Design coordinates with Studio® bath wall set (sold separately)

Nominal Dimensions:

60 in x 32 in x 19 in (1524 mm x 812 mm x 482 mm)



Description	Net Wt	SKU	Color	List Price
Studio® 60 x 32-Inch Integral Apron Bathtub With Right-Hand Outlet	80 lb	2946102.011	Arctic	1,034
	36.3 kg	2946102.020	White	1,034

Required Components:

Bathtub Drain	6 lb 3.1 kg	1583470.002	Polished Chrome	198
		1583470.011	Arctic	338
		1583470.020	White	338
		1583470.295	Brushed Nickel	338
Deep Soak® Bathtub Drain	2 lb 1.0 kg	1640305.002	Polished Chrome	174
		1640305.011	Arctic	234
		1640305.020	White	195
		1640305.295	Brushed Nickel	312

Optional Components:

Studio® 60 x 32 x 60-Inch Bath Wall Set	24 lb 11.3 kg	2946BW.011	Arctic	995
---	------------------	------------	--------	-----



Studio® 60 x 32-Inch Integral Apron Bathtub With Left-Hand Outlet

- Minimalist design with contoured lumbar support
- High-quality acrylic with fiberglass reinforcement
- Easy-to-clean high-gloss surface that's UV stable and stain resistant
- Integral 3-sided tile/water retention flange
- Integral apron for recess application
- Pre-leveled tub bottom for easier installation
- ADA compliant
- Limited lifetime warranty
- Design coordinates with Studio® bath wall set (sold separately)

Nominal Dimensions:

60 in x 32 in x 19 in (1524 mm x 812 mm x 482 mm)



Description	Net Wt	SKU	Color	List Price
Studio® 60 x 32-Inch Integral Apron Bathtub With Left-Hand Outlet	80 lb	2946202.011	Arctic	1,034
	36.3 kg	2946202.020	White	1,034

Required Components:

Bathtub Drain	6 lb 3.1 kg	1583470.002	Polished Chrome	198
		1583470.011	Arctic	338
		1583470.020	White	338
		1583470.295	Brushed Nickel	338
Deep Soak® Bathtub Drain	2 lb 1.0 kg	1640305.002	Polished Chrome	174
		1640305.011	Arctic	234
		1640305.020	White	195
		1640305.295	Brushed Nickel	312

Optional Components:

Studio® 60 x 32 x 60-Inch Bath Wall Set	24 lb 11.3 kg	2946BW.011	Arctic	995
---	------------------	------------	--------	-----



Studio® 60 x 30-Inch Integral Apron Bathtub Above Floor Rough with Right-Hand Outlet

- Minimalist design with contoured lumbar support
- Above floor rough installation
- High-quality acrylic with fiberglass reinforcement
- Easy to clean high-gloss surface that's UV stable and stain resistant
- Integral 3-sided tile/water retention flange
- Integral apron for recess application
- Pre-leveled tub bottom for easier installation
- ADA compliant
- Limited lifetime warranty

Nominal Dimensions:

60 in x 30 in x 18 in (1524 mm x 762 mm x 457 mm)



Description	Net Wt	SKU	Color	List Price
Studio® 60 x 30-Inch Integral Apron Bathtub Above Floor Rough with Right-Hand Outlet	56 lb	2573102.020	White	1,255
	25.4 kg	2573102.011	Arctic	1,255

Required Components:

Bathtub Drain	6 lb 3.1 kg	1583470.002	Polished Chrome	198
		1583470.011	Arctic	338
		1583470.020	White	338
		1583470.295	Brushed Nickel	338
Deep Soak® Bathtub Drain	2 lb 1.0 kg	1640305.002	Polished Chrome	174
		1640305.011	Arctic	234
		1640305.020	White	195
		1640305.295	Brushed Nickel	312



Studio® 60 x 30-Inch Integral Apron Bathtub Above Floor Rough With Left-Hand Outlet

- Minimalist design with contoured lumbar support
- Above floor rough installation
- High-quality acrylic with fiberglass reinforcement
- Easy to clean high-gloss surface that's UV stable and stain resistant
- Integral 3-sided tile/water retention flange
- Integral apron for recess application
- Pre-leveled tub bottom for easier installation
- ADA compliant
- Limited lifetime warranty

Nominal Dimensions:

60 in x 30 in x 18 in (1524 mm x 762 mm x 457 mm)



Description	Net Wt	SKU	Color	List Price
Studio® 60 x 30-Inch Integral Apron Bathtub Above Floor Rough With Left-Hand Outlet	56 lb	2573202.020	White	1,255
	25.4 kg	2573202.011	Arctic	1,255

Required Components:

Bathtub Drain	6 lb 3.1 kg	1583470.002	Polished Chrome	198
		1583470.011	Arctic	338
		1583470.020	White	338
		1583470.295	Brushed Nickel	338
Deep Soak® Bathtub Drain	2 lb 1.0 kg	1640305.002	Polished Chrome	174
		1640305.011	Arctic	234
		1640305.020	White	195
		1640305.295	Brushed Nickel	312



Studio® 60 x 32-Inch Integral Apron Bathtub Above Floor Rough With Right-Hand Outlet

- Minimalist design with contoured lumbar support
- Above floor rough installation
- High-quality acrylic with fiberglass reinforcement
- Easy to clean high-gloss surface that's UV stable and stain resistant
- Integral 3-sided tile/water retention flange
- Integral apron for recess application
- Pre-leveled tub bottom for easier installation
- ADA compliant
- Limited lifetime warranty
- Design coordinates with Studio® bath wall set (sold separately)

Nominal Dimensions:

60 in x 32 in x 18 in (1524 mm x 812 mm x 457 mm)



Description	Net Wt	SKU	Color	List Price
Studio® 60 x 32-Inch Integral Apron Bathtub Above Floor Rough With Right-Hand Outlet	60 lb	2574102.020	White	1,343
	27.2 kg	2574102.011	Arctic	1,343

Required Components:

Bathtub Drain	6 lb 3.1 kg	1583470.002	Polished Chrome	198
		1583470.011	Arctic	338
		1583470.020	White	338
		1583470.295	Brushed Nickel	338
Deep Soak® Bathtub Drain	2 lb 1.0 kg	1640305.002	Polished Chrome	174
		1640305.011	Arctic	234
		1640305.020	White	195
		1640305.295	Brushed Nickel	312

Optional Components:

Studio® 60 x 32 x 60-Inch Bath Wall Set	24 lb 11.3 kg	2946BW.011	Arctic	995
---	------------------	------------	--------	-----



Studio® 60 x 32-Inch Integral Apron Bathtub Above Floor Rough With Left-Hand Outlet

- Minimalist design with contoured lumbar support
- Above floor rough installation
- High-quality acrylic with fiberglass reinforcement
- Easy to clean high-gloss surface that's UV stable and stain resistant
- Integral 3-sided tile/water retention flange
- Integral apron for recess application
- Pre-leveled tub bottom for easier installation
- ADA compliant
- Limited lifetime warranty
- Design coordinates with Studio® bath wall set (sold separately)

Nominal Dimensions:

60 in x 32 in x 18 in (1524 mm x 812 mm x 457 mm)



Description	Net Wt	SKU	Color	List Price
Studio® 60 x 32-Inch Integral Apron Bathtub Above Floor Rough With Left-Hand Outlet	60 lb	2574202.020	White	1,343
	27.2 kg	2574202.011	Arctic	1,343

Required Components:

Bathtub Drain	6 lb 3.1 kg	1583470.002	Polished Chrome	198
		1583470.011	Arctic	338
		1583470.020	White	338
		1583470.295	Brushed Nickel	338
Deep Soak® Bathtub Drain	2 lb 1.0 kg	1640305.002	Polished Chrome	174
		1640305.011	Arctic	234
		1640305.020	White	195
		1640305.295	Brushed Nickel	312

Optional Components:

Studio® 60 x 32 x 60-Inch Bath Wall Set	24 lb 11.3 kg	2946BW.011	Arctic	995
---	------------------	------------	--------	-----



Studio® 60 x 32-Inch Bath Wall Set

- Includes two side walls and one back wall
- Six integrated extra deep 4-½" (114 mm) shelves
- High-impact polystyrene
- Mounts directly to studs – no backer board needed
- Tongue and groove inter-locking for alignment and to prevent water seepage
- For use with 011 Arctic White 60" x 32" (1524 x 813 mm) bathtub models
- Limited lifetime warranty

Nominal Dimensions:

60 in x 32 in x 58 in (1524 mm x 812 mm x 1473 mm)



Description	Net Wt	SKU	Color	List Price
Studio® 60 x 32 x 60-Inch Bath Wall Set	24 lb 11.3 kg	2946BW.011	Arctic	995

Studio® Drop-in Bathtubs

Product Description

- High-gloss acrylic with fiberglass reinforcement
- Minimalist design with contoured lumbar support
- Spacious bathing well
- Soaking depth of 17-3/4" (451 mm) for a deep relaxing soak
- Pre-leveled tub bottom
- Drop-in or under mount installation

Zero-Edge Profile

- Low-profile, 1/2" (13 mm) deck height can be mounted flush with surrounding tile



Zero-Edge Profile



Studio® 60 x 32-Inch Drop-In Bathtub With Zero Edge

- Minimalist design with contoured lumbar support
- Standard deck height for a contemporary appearance
- Zero Edge profile
- High-quality acrylic with fiberglass reinforcement
- Easy-to-clean high-gloss surface that's UV stable and stain resistant
- Pre-leveled tub bottom for easier installation
- Drop-in or undermount installation
- Limited lifetime warranty

Nominal Dimensions:

59-1/2 in x 31-1/2 in x 22-1/2 in (1511 mm x 800 mm x 571 mm)



Description	Net Wt	SKU	Color	List Price
Studio® 60 x 32-Inch Drop-In Soaking Bathtub with Zero Edge	103 lb 46.8 kg	2932002-D0.020	White	1,658

Required Components:

Bathtub Drain	6 lb 3.1 kg	1583470.002	Polished Chrome	198
		1583470.020	White	338
		1583470.295	Brushed Nickel	338
Deep Soak® Bathtub Drain	2 lb 1.0 kg	1640305.002	Polished Chrome	174
		1640305.020	White	195
		1640305.295	Brushed Nickel	312



Studio® 60 x 36-Inch Drop-In Bathtub With Zero Edge

- Minimalist design with contoured lumbar support
- Standard deck height for a contemporary appearance
- Zero Edge profile
- High-quality acrylic with fiberglass reinforcement
- Easy-to-clean high-gloss surface that's UV stable and stain resistant
- Pre-leveled tub bottom for easier installation
- Drop-in or undermount installation
- Limited lifetime warranty

Nominal Dimensions:

59-1/2 in x 35-1/2 in x 22-1/2 in (1511 mm x 901 mm x 571 mm)



Description	Net Wt	SKU	Color	List Price
Studio® 60 x 36-Inch Drop-In Soaking Bathtub With Zero Edge	121 lb 54.9 kg	2934002-D0.020	White	1,746

Required Components:

Bathtub Drain	6 lb 3.1 kg	1583470.002	Polished Chrome	198
		1583470.020	White	338
		1583470.295	Brushed Nickel	338
Deep Soak® Bathtub Drain	2 lb 1.0 kg	1640305.002	Polished Chrome	174
		1640305.020	White	195
		1640305.295	Brushed Nickel	312



Studio® 66 x 36-Inch Drop-In Bathtub With Zero Edge

- Minimalist design with contoured lumbar support
- Standard deck height for a contemporary appearance
- Zero Edge profile
- High-quality acrylic with fiberglass reinforcement
- Easy-to-clean high-gloss surface that's UV stable and stain resistant
- Pre-leveled tub bottom for easier installation
- Drop-in or undermount installation
- Limited Lifetime warranty

Nominal Dimensions:

65-1/2 in x 35-1/2 in x 22-1/2 in (1663 mm x 901 mm x 571 mm)



Description	Net Wt	SKU	Color	List Price
Studio® 66 x 36-Inch Drop-In Bathtub With Zero Edge	131 lb 59.5 kg	2938002-D0.020	White	1,827

Required Components:

Bathtub Drain	6 lb 3.1 kg	1583470.002	Polished Chrome	198
		1583470.020	White	338
		1583470.295	Brushed Nickel	338
Deep Soak® Bathtub Drain	2 lb 1.0 kg	1640305.002	Polished Chrome	174
		1640305.020	White	195
		1640305.295	Brushed Nickel	312

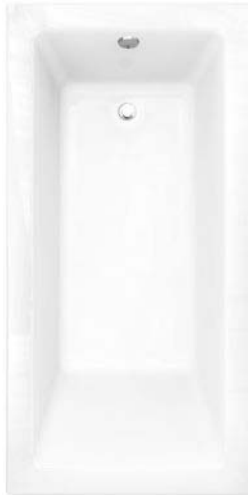

Studio® 72 x 36-Inch Drop-In Bathtub With Zero Edge

- Minimalist design with contoured lumbar support
- Standard deck height for a contemporary appearance
- Zero Edge profile
- High-quality acrylic with fiberglass reinforcement
- Easy-to-clean high-gloss surface that's UV stable and stain resistant
- Pre-leveled tub bottom for easier installation
- Drop-in or undermount installation
- Limited lifetime warranty

Nominal Dimensions:

71-1/2 in x 35-1/2 in x 22-1/2 in (1816 mm x 901 mm x 571 mm)



Description	Net Wt	SKU	Color	List Price
Studio® 72 x 36-Inch Drop-In Soaking Bathtub with Zero Edge	141 lb 64.0 kg	2940002-D0.020	White	1,953

Required Components:

Bathtub Drain	6 lb 3.1 kg	1583470.002	Polished Chrome	198
		1583470.020	White	338
		1583470.295	Brushed Nickel	338
Deep Soak® Bathtub Drain	2 lb 1.0 kg	1640305.002	Polished Chrome	174
		1640305.020	White	195
		1640305.295	Brushed Nickel	312



Town Square® S 60 x 30-Inch Integral Apron Bathtub With Right-Hand Outlet

- Traditional design with contoured lumbar support
- High-quality acrylic with fiberglass reinforcement
- Easy-to-clean high-gloss surface that's UV stable and stain resistant
- Integral 3-sided tile/water retention flange
- Integral apron for recess application
- Pre-leveled tub bottom for easier installation
- ADA compliant
- Limited lifetime warranty

Nominal Dimensions:

60 in x 30 in x 19 in (1524 mm x 762 mm x 482 mm)



Description	Net Wt	SKU	Color	List Price
Town Square® S 60 x 30-Inch Integral Apron Bathtub With Right-Hand Outlet	80 lb 36.3 kg	2545102.020	White	1,129

Required Components:

Bathtub Drain	6 lb 3.1 kg	1583470.002	Polished Chrome	198
		1583470.020	White	338
		1583470.295	Brushed Nickel	338
Deep Soak® Bathtub Drain	2 lb 1.0 kg	1640305.002	Polished Chrome	174
		1640305.020	White	195
		1640305.295	Brushed Nickel	312



Town Square® S 60 x 30-Inch Integral Apron Bathtub With Left-Hand Outlet

- Traditional design with contoured lumbar support
- High-quality acrylic with fiberglass reinforcement
- Easy-to-clean high-gloss surface that's UV stable and stain resistant
- Integral 3-sided tile/water retention flange
- Integral apron for recess application
- Pre-leveled tub bottom for easier installation
- ADA compliant
- Limited lifetime warranty

Nominal Dimensions:

60 in x 30 in x 19 in (1524 mm x 762 mm x 482 mm)



Description	Net Wt	SKU	Color	List Price
Town Square® S 60 x 30-Inch Integral Apron Bathtub With Left-Hand Outlet	80 lb 36.3 kg	2545202.020	White	1,129

Required Components:

Bathtub Drain	6 lb 3.1 kg	1583470.002	Polished Chrome	198
		1583470.020	White	338
		1583470.295	Brushed Nickel	338
Deep Soak® Bathtub Drain	2 lb 1.0 kg	1640305.002	Polished Chrome	174
		1640305.020	White	195
		1640305.295	Brushed Nickel	312



Town Square® S 60 x 32-Inch Integral Apron Bathtub With Right-Hand Outlet

- Traditional design with contoured lumbar support
- High-quality acrylic with fiberglass reinforcement
- Easy-to-clean high-gloss surface that's UV stable and stain resistant
- Integral 3-sided tile/water retention flange
- Integral apron for recess application
- Pre-leveled tub bottom for easier installation
- ADA compliant
- Limited lifetime warranty

Nominal Dimensions:

60 in x 32 in x 20 in (1524 mm x 812 mm x 508 mm)



Description	Net Wt	SKU	Color	List Price
Town Square® S 60 x 32-Inch Integral Apron Bathtub With Right-Hand Outlet	84 lb 38.1 kg	2544102.020	White	1,141

Required Components:

Bathtub Drain	6 lb 3.1 kg	1583470.002	Polished Chrome	198
		1583470.020	White	338
		1583470.295	Brushed Nickel	338
Deep Soak® Bathtub Drain	2 lb 1.0 kg	1640305.002	Polished Chrome	174
		1640305.020	White	195
		1640305.295	Brushed Nickel	312

Optional Components:

Euro 57-Inch Height Semi-Frameless Sliding Tub Door	85 lb 38.6 kg	AM00350400.006	Brushed Nickel	1,189
		AM00350400.213	Silver Shine	882
		AM00350400.224	Oil Rubbed Bronze	1,189
	82 lb 37.2 kg	AM00350422.006	Brushed Nickel	1,331
		AM00350422.213	Silver Shine	1,082
		AM00350422.224	Oil Rubbed Bronze	1,331



Town Square® S 60 x 32-Inch Integral Apron Bathtub With Left-Hand Outlet

- Traditional design with contoured lumbar support
- High-quality acrylic with fiberglass reinforcement
- Easy-to-clean high-gloss surface that's UV stable and stain resistant
- Integral 3-sided tile/water retention flange
- Integral apron for recess application
- Pre-leveled tub bottom for easier installation
- ADA compliant
- Limited lifetime warranty

Nominal Dimensions:

60 in x 32 in x 20 in (1524 mm x 812 mm x 508 mm)



Description	Net Wt	SKU	Color	List Price
Town Square® S 60 x 32-Inch Integral Apron Bathtub With Left-Hand Outlet	84 lb 38.1 kg	2544202.020	White	1,141

Required Components:

Bathtub Drain	6 lb 3.1 kg	1583470.002	Polished Chrome	198
		1583470.020	White	338
		1583470.295	Brushed Nickel	338
Deep Soak® Bathtub Drain	2 lb 1.0 kg	1640305.002	Polished Chrome	174
		1640305.020	White	195
		1640305.295	Brushed Nickel	312

Optional Components:

Euro 57-Inch Height Semi-Frameless Sliding Tub Door	85 lb 38.6 kg	AM00350400.006	Brushed Nickel	1,189
		AM00350400.213	Silver Shine	882
		AM00350400.224	Oil Rubbed Bronze	1,189
	82 lb 37.2 kg	AM00350422.006	Brushed Nickel	1,331
		AM00350422.213	Silver Shine	1,082
		AM00350422.224	Oil Rubbed Bronze	1,331



Cadet® 60 x 42-Inch Drop-In Bathtub With EverClean® Hydromassage System

- Transitional style hydromassage whirlpool with EverClean® plumbing system
- Form-fitted lumbar area
- Molded-in armrests with elbow supports
- Eight multi-directional and flow-adjustable Clean Jets™ including two in the lumbar area
- Single speed pump/motor with side mounted on/off air switch
- Two silent air volume controls
- Quick connect Safe- T Heater connection system (must order Safe- T Heater separately)
- High-quality acrylic with fiberglass reinforcement
- Easy-to-clean high-gloss surface that's UV stable and stain resistant
- Pre-leveled tub bottom for easier installation
- 2-year warranty

Nominal Dimensions:

60 in x 42 in x 19-3/4 in (1524 mm x 1066 mm x 501 mm)



Description	Net Wt	SKU	Color	List Price
Cadet® 60 x 42-Inch Drop-In Bathtub With EverClean® Hydromassage System	105 lb 47.7 kg	2772018WC.020	White	2,312

Required Components:

Bathtub Drain	6 lb 3.1 kg	1583470.002	Polished Chrome	198
		1583470.020	White	338
		1583470.295	Brushed Nickel	338
Deep Soak® Bathtub Drain	2 lb 1.0 kg	1640305.002	Polished Chrome	174
		1640305.020	White	195
		1640305.295	Brushed Nickel	312

Optional Components:

Universal Tile Bead Kit	2 lb 1.0 kg	751755-100	White	79
Universal Tile Bead Adhesive (Bulk)	21 lb 9.5 kg	9330014		52



Cadet® 72 x 42-Inch Drop-In Bathtub With EverClean® Hydromassage System

- Transitional style hydromassage whirlpool with EverClean® plumbing system
- Form-fitted lumbar area
- Molded-in armrests with elbow supports
- Eight multi-directional and flow-adjustable Clean Jets™ including two in the lumbar area
- Single speed pump/motor with side mounted on/off air switch
- Two silent air volume controls
- Quick connect Safe-T Heater connection system (must order Safe- T Heater separately)
- High-quality acrylic with fiberglass reinforcement
- Easy-to-clean high-gloss surface that's UV stable and stain resistant
- Pre-leveled tub bottom for easier installation
- 2-year warranty

Nominal Dimensions:

72 in x 42 in x 19-3/4 in (1828 mm x 1066 mm x 501 mm)



Description	Net Wt	SKU	Color	List Price
Cadet® 72 x 42-Inch Drop-In Bathtub With EverClean® Hydromassage System	122 lb 55.4 kg	2774018WC.020	White	2,399

Required Components:

Bathtub Drain	6 lb 3.1 kg	1583470.002	Polished Chrome	198
		1583470.020	White	338
		1583470.295	Brushed Nickel	338
Deep Soak® Bathtub Drain	2 lb 1.0 kg	1640305.002	Polished Chrome	174
		1640305.020	White	195
		1640305.295	Brushed Nickel	312

Optional Components:

Universal Tile Bead Kit	2 lb 1.0 kg	751755-100	White	79
Universal Tile Bead Adhesive (Bulk)	21 lb 9.5 kg	9330014		52



Evolution® 60 x 32-Inch Deep Soak® Integral Apron Bathtub Right-Hand Outlet With EverClean® Hydromassage System

- Transitional style hydromassage whirlpool with EverClean® plumbing system
- Eight multi-directional and flow-adjustable Clean Jets™ including two in the lumbar area
- Single speed pump/motor with side mounted on/off air switch
- Two silent air volume controls
- High-quality acrylic with fiberglass reinforcement
- Easy-to-clean high-gloss surface that's UV stable and stain resistant
- Integral 3-sided tile/water retention flange
- Integral apron with removable access panel
- Dual molded-in armrests
- Must order Deep Soak® Max Drain
- Quick connect Safe-T Heater connection system (must order Safe-T Heater separately)
- Limited lifetime warranty

Nominal Dimensions:

60 in x 32 in x 21-1/2 in (1524 mm x 812 mm x 546 mm)



Description	Net Wt	SKU	Color	List Price
Evolution® 60 x 32-Inch Deep Soak® Integral Apron Bathtub Right-Hand Outlet With EverClean® Hydromassage System	96 lb 43.6 kg	2425VC-RHO.020	White	2,033

Required Components:

Deep Soak® Max Bathtub Drain	6 lb 2.7 kg	1599205.002	Polished Chrome	195
		1599205.020	White	195
		1599205.295	Brushed Nickel	312

Optional Components:

Safe-T Heater	1 lb 0.8 kg	9075120	No Finish	393
Euro 57-Inch Height Semi-Frameless Sliding Tub Door	85 lb 38.6 kg	AM00350400.006	Brushed Nickel	1,189
		AM00350400.213	Silver Shine	882
		AM00350400.224	Oil Rubbed Bronze	1,189
	82 lb 37.2 kg	AM00350422.006	Brushed Nickel	1,331
		AM00350422.213	Silver Shine	1,082
		AM00350422.224	Oil Rubbed Bronze	1,331
Prestige 58-1/2-Inch Height Framed Sliding Tub Door	58 lb 26.3 kg	AM00750400.006	Brushed Nickel	951
		AM00750400.213	Silver Shine	717
		AM00750400.224	Oil Rubbed Bronze	951
Prestige 58-1/2-Inch Framed Sliding Tub Door		AM00750422.006	Brushed Nickel	998
		AM00750422.213	Silver Shine	717
		AM00750422.224	Oil Rubbed Bronze	998
Prestige 58-1/2-Inch Height Framed Sliding Tub Door		AM00750436.006	Brushed Nickel	998
		AM00750436.213	Silver Shine	717
		AM00750436.224	Oil Rubbed Bronze	998



Evolution® 60 x 32-Inch Deep Soak® Integral Apron Bathtub Left-Hand Outlet With EverClean® Hydromassage System

- Transitional style hydromassage whirlpool with EverClean® plumbing system
- Eight multi-directional and flow-adjustable Clean Jets™ including two in the lumbar area
- Single speed pump/motor with side mounted on/off air switch
- Two silent air volume controls
- High-quality acrylic with fiberglass reinforcement
- Easy-to-clean high-gloss surface that's UV stable and stain resistant
- Integral 3-sided tile/water retention flange
- Integral apron with removable access panel
- Dual molded-in armrests
- Must order Deep Soak® Max Drain
- Quick connect Safe-T Heater connection system (must order Safe-T Heater separately)
- Limited lifetime warranty

Nominal Dimensions:

60 in x 32 in x 21-1/2 in (1524 mm x 812 mm x 546 mm)



Description	Net Wt	SKU	Color	List Price
Evolution® 60 x 32-Inch Deep Soak® Integral Apron Bathtub Left-Hand Outlet With EverClean® Hydromassage System	96 lb 43.6 kg	2425VC-LHO.020	White	2,033

Required Components:

Deep Soak® Max Bathtub Drain	6 lb 2.7 kg	1599205.002	Polished Chrome	195
		1599205.020	White	195
		1599205.295	Brushed Nickel	312



Evolution® 60 x 32-Inch Deep Soak® Drop-In Bathtub With EverClean® Hydromassage System

- Transitional style hydromassage whirlpool with EverClean® plumbing system
- Eight multi-directional and flow-adjustable Clean Jets™ including two in the lumbar area
- Single speed pump/motor with side mounted on/off air switch
- Two silent air volume controls
- High-quality acrylic with fiberglass reinforcement
- Easy to clean high-gloss surface that's UV stable and stain resistant
- Dual molded-in armrests
- Pre-leveled tub bottom for easier installation
- Drop-in or undermount option
- Must order Deep Soak® Max Drain
- Quick connect Safe-T Heater connection system (must order Safe-T Heater separately)
- Limited lifetime warranty

Nominal Dimensions:

60 in x 32 in x 21-1/2 in (1524 mm x 812 mm x 546 mm)



Description	Net Wt	SKU	Color	List Price
Evolution® 60 x 32-Inch Deep Soak® Drop-In Bathtub With EverClean® Hydromassage System	90 lb 40.9 kg	2422VC.020	White	2,037

Required Components:

Deep Soak® Max Bathtub Drain	6 lb 2.7 kg	1599205.002	Polished Chrome	195
		1599205.020	White	195
		1599205.295	Brushed Nickel	312

Optional Components:

Universal Tile Bead Kit	2 lb 1.0 kg	751755-100	White	79
Universal Tile Bead Adhesive (Bulk)	21 lb 9.5 kg	9330014		52



Evolution® 60 x 36-Inch Deep Soak® Drop-In Bathtub With EverClean® Hydromassage System

- Transitional style hydromassage whirlpool with EverClean® plumbing system
- Eight multi-directional and flow-adjustable Clean Jets™ including two in the lumbar area
- Single speed pump/motor with side mounted on/off air switch
- Two silent air volume controls
- High-quality acrylic with fiberglass reinforcement
- Easy-to-clean high-gloss surface that's UV stable and stain resistant
- Dual molded-in armrests
- Pre-leveled tub bottom for easier installation
- Drop-in or undermount option
- Must order Deep Soak® Max Drain
- Quick connect Safe-T Heater connection system (must order Safe-T Heater separately)
- Limited lifetime warranty

Nominal Dimensions:

60 in x 36 in x 20-1/2 in (1524 mm x 914 mm x 520 mm)



Description	Net Wt	SKU	Color	List Price
Evolution® 60 x 36-Inch Deep Soak® Drop-In Bathtub With EverClean® Hydromassage System	111 lb 50.4 kg	2771VC.020	White	2,129

Required Components:

Deep Soak® Max Bathtub Drain	6 lb 2.7 kg	1599205.002	Polished Chrome	195
		1599205.020	White	195
		1599205.295	Brushed Nickel	312

Optional Components:

Universal Tile Bead Kit	2 lb 1.0 kg	751755-100	White	79
Universal Tile Bead Adhesive (Bulk)	21 lb 9.5 kg	9330014		52



Evolution® 72 x 36-Inch Deep Soak® Drop-In Bathtub With EverClean® Hydromassage System

- Transitional style hydromassage whirlpool with EverClean® plumbing system
- Ten multi-directional and flow-adjustable Clean Jets™ including two in the lumbar area
- Single speed pump/motor with side mounted on/off air switch
- Two silent air volume controls
- High-quality acrylic with fiberglass reinforcement
- Easy to clean high-gloss surface that's UV stable and stain resistant
- Dual molded-in armrests
- Pre-leveled tub bottom for easier installation
- Drop-in or undermount option
- Must order Deep Soak® Max Drain
- Quick connect Safe-T Heater connection system (must order Safe-T Heater separately)
- Limited lifetime warranty

Nominal Dimensions:

72 in x 36 in x 20-1/2 in (1828 mm x 914 mm x 520 mm)



Description	Net Wt	SKU	Color	List Price
Evolution® 72 x 36-Inch Deep Soak® Drop-In Bathtub With EverClean® Hydromassage System	135 lb 61.3 kg	7236VC.020	White	2,538

Required Components:

Deep Soak® Max Bathtub Drain	6 lb 2.7 kg	1599205.002	Polished Chrome	195
		1599205.020	White	195
		1599205.295	Brushed Nickel	312

Optional Components:

Universal Tile Bead Kit	2 lb 1.0 kg	751755-100	White	79
Universal Tile Bead Adhesive (Bulk)	21 lb 9.5 kg	9330014		52



Evolution® 60 x 32-Inch Deep Soak® Integral Apron Bathtub Right-Hand Outlet With EverClean® Air Bath System

- Transitional style airbath with EverClean® plumbing system
- Chrome air jets with automatic water purge with timer
- Variable Speed Blower with heater
- High-quality acrylic with fiberglass reinforcement
- Easy-to-clean high-gloss surface that's UV stable and stain resistant
- Integral 3-sided tile/water retention flange
- Integral apron with removable access panel
- Dual molded-in armrests
- Must order Deep Soak® Max Drain
- Limited lifetime warranty

Nominal Dimensions:

60 in x 32 in x 21-1/2 in (1524 mm x 812 mm x 546 mm)



Description	Net Wt	SKU	Color	List Price
Evolution® 60 x 32-Inch Deep Soak® Integral Apron Bathtub Right-Hand Outlet With EverClean® Air Bath System	88 lb 40.2 kg	2425168C.020	White	3,134

Required Components:

Deep Soak® Max Bathtub Drain	Net Wt	SKU	Color	List Price
	6 lb 2.7 kg	1599205.002	Polished Chrome	195
		1599205.020	White	195
		1599205.295	Brushed Nickel	312



Evolution® 60 x 32-Inch Deep Soak® Integral Apron Bathtub Left-Hand Outlet With EverClean® Air Bath System

- Transitional style airbath with EverClean® plumbing system
- Chrome air jets with automatic water purge with timer
- Variable speed air blower with heater
- High-quality acrylic with fiberglass reinforcement
- Easy-to-clean high-gloss surface that's UV stable and stain resistant
- Integral 3-sided tile/water retention flange
- Integral apron with removable access panel
- Dual molded-in armrests
- Must order Deep Soak® Max Drain
- Limited lifetime warranty

Nominal Dimensions:

60 in x 32 in x 21.5 in (1524 mm x 812 mm x 546 mm)



Description	Net Wt	SKU	Color	List Price
Evolution® 60 x 32-Inch Deep Soak® Integral Apron Bathtub Left-Hand Outlet With EverClean® Air Bath System	88 lb 40.2 kg	2425268C.020	White	3,134

Required Components:

Deep Soak® Max Bathtub Drain	Net Wt	SKU	Color	List Price
	6 lb 2.7 kg	1599205.002	Polished Chrome	195
		1599205.020	White	195
		1599205.295	Brushed Nickel	312



Evolution® 60 x 32-Inch Deep Soak® Drop-In Bathtub With EverClean® Air Bath System

- Transitional style air bath with EverClean® plumbing system
- Chrome air jets with automatic water purge and timer
- Variable speed air blower with heater
- High-quality acrylic with fiberglass reinforcement
- Easy-to-clean high-gloss surface that's UV stable and stain resistant
- Dual molded-in armrests
- Pre-leveled tub bottom for easier installation
- Drop-in or undermount option
- Must order Deep Soak® Max Drain
- Limited lifetime warranty

Nominal Dimensions:

60 in x 32 in x 21-1/2 in (1524 mm x 812 mm x 546 mm)



Description	Net Wt	SKU	Color	List Price
Evolution® 60 x 32-Inch Deep Soak® Drop-In Bathtub With EverClean® Air Bath System	85 lb 38.6 kg	2422068C.020	White	3,036

Required Components:

Deep Soak® Max Bathtub Drain	6 lb 2.7 kg	1599205.002	Polished Chrome	195
		1599205.020	White	195
		1599205.295	Brushed Nickel	312

Optional Components:

Universal Tile Bead Kit	2 lb 1.0 kg	751755-100	White	79
Universal Tile Bead Adhesive (Bulk)	21 lb 9.5 kg	9330014		52



Evolution® 60 x 36-Inch Deep Soak® Drop-In Bathtub With EverClean® Air Bath System

- Transitional style air bath with EverClean® plumbing system
- Chrome air jets with automatic water purge and timer
- Variable speed air blower with heater
- High-quality acrylic with fiberglass reinforcement
- Easy-to-clean high-gloss surface that's UV stable and stain resistant
- Dual molded-in armrests
- Pre-leveled tub bottom for easier installation
- Drop-in or undermount option
- Must order Deep Soak® Max Drain
- Limited lifetime warranty

Nominal Dimensions:

60 in x 36 in x 21-1/2 in (1524 mm x 914 mm x 546 mm)



Description	Net Wt	SKU	Color	List Price
Evolution® 60 x 36-Inch Deep Soak® Drop-In Bathtub With EverClean® Air Bath System	88 lb 40.0 kg	2771068C.020	White	3,145

Required Components:

Deep Soak® Max Bathtub Drain	6 lb 2.7 kg	1599205.002	Polished Chrome	195
		1599205.020	White	195
		1599205.295	Brushed Nickel	312

Optional Components:

Universal Tile Bead Kit	2 lb 1.0 kg	751755-100	White	79
Universal Tile Bead Adhesive (Bulk)	21 lb 9.5 kg	9330014		52



Evolution® 72 x 36-Inch Deep Soak® Drop-In Bathtub With EverClean® Air Bath System

- Transitional style air bath with EverClean® plumbing system
- Chrome air jets with automatic water purge and timer
- Variable speed air blower with heater
- High-quality acrylic with fiberglass reinforcement
- Easy-to-clean high-gloss surface that's UV stable and stain resistant
- Dual molded-in armrests
- Pre-leveled tub bottom for easier installation
- Drop-in or undermount option
- Must order Deep Soak® Max Drain
- Limited lifetime warranty

Nominal Dimensions:

72 in x 36 in x 21-1/4 in (1828 mm x 914 mm x 539 mm)



Description	Net Wt	SKU	Color	List Price
Evolution® 72 x 36-Inch Deep Soak® Drop-In Bathtub With EverClean® Air Bath System	90 lb 40.9 kg	7236068C.020	White	3,440

Required Components:

Deep Soak® Max Bathtub Drain	6 lb 2.7 kg	1599205.002	Polished Chrome	195
		1599205.020	White	195
		1599205.295	Brushed Nickel	312

Optional Components:

Universal Tile Bead Kit	2 lb 1.0 kg	751755-100	White	79
Universal Tile Bead Adhesive (Bulk)	21 lb 9.5 kg	9330014		52



Evolution® 60 x 32-Inch Deep Soak® Integral Apron Bathtub Right-Hand Outlet With EverClean® Combination Spa System

- Transitional style hydromassage whirlpool and air bath with EverClean® plumbing system
- Eight multi-directional and flow-adjustable Clean Jets™ including two in the lumbar area
- Single speed pump/motor with side mounted on/off air switch
- Two silent air volume controls
- Chrome air jets with automatic water purge and timer
- Variable speed air blower with heater
- High-quality acrylic with fiberglass reinforcement
- Easy-to-clean high-gloss surface that's UV stable and stain resistant
- Integral 3-sided tile/water retention flange
- Integral apron with removable access panel
- Dual molded-in armrests
- Must order Deep Soak® Max Drain
- Limited lifetime warranty

Nominal Dimensions:

60 in x 32 in x 21-1/2 in (1524 mm x 812 mm x 546 mm)



Description	Net Wt	SKU	Color	List Price
Evolution® 60 x 32-Inch Deep Soak® Integral Apron Bathtub Right-Hand Outlet With EverClean® Combination Spa System	96 lb 43.6 kg	2425V518C.020	White	4,782

Required Components:

Deep Soak® Max Bathtub Drain	6 lb 2.7 kg	1599205.002	Polished Chrome	195
		1599205.020	White	195
		1599205.295	Brushed Nickel	312



Evolution® 60 x 32-Inch Deep Soak® Integral Apron Bathtub Left-Hand Outlet With EverClean® Combination Spa System

- Transitional style hydromassage whirlpool and air bath with EverClean® plumbing system
- Eight multi-directional and flow-adjustable Clean Jets™ including two in the lumbar area
- Single speed pump/motor with side mounted on/off air switch
- Two silent air volume controls
- Chrome air jets with automatic water purge and timer
- Variable speed air blower with heater
- High-quality acrylic with fiberglass reinforcement
- Easy-to-clean high-gloss surface that's UV stable and stain resistant
- Integral 3-sided tile/water retention flange
- Integral apron with removable access panel
- Dual molded-in armrests
- Must order Deep Soak® Max Drain
- Limited lifetime warranty

Nominal Dimensions:

60 in x 32 in x 21-1/2 in (1524 mm x 812 mm x 546 mm)



Description	Net Wt	SKU	Color	List Price
Evolution® 60 x 32-Inch Deep Soak® Integral Apron Bathtub Left-Hand Outlet With EverClean® Combination Spa System	96 lb 43.6 kg	2425V618C.020	White	4,782

Required Components:

Deep Soak® Max Bathtub Drain	6 lb 2.7 kg	1599205.002	Polished Chrome	195
		1599205.020	White	195
		1599205.295	Brushed Nickel	312



Evolution® 60 x 32-Inch Deep Soak® Drop-In Bathtub With EverClean® Combination Spa System

- Transitional style hydromassage whirlpool and air bath with EverClean® plumbing system
- Eight multi-directional and flow-adjustable Clean Jets™ including two in the lumbar area
- Single speed pump/motor with side mounted on/off air switch
- Two silent air volume controls
- Chrome air jets with automatic water purge and timer
- Variable speed air blower with heater
- High-quality acrylic with fiberglass reinforcement
- Easy-to-clean high-gloss surface that's UV stable and stain resistant
- Dual molded-in armrests
- Pre-leveled tub bottom for easier installation
- Drop-in or undermount option
- Must order Deep Soak® Max Drain
- Quick connect Safe-T Heater connection system (must order Safe-T Heater separately)
- Limited lifetime warranty

Nominal Dimensions:

60 in x 32 in x 21-1/2 in (1524 mm x 812 mm x 546 mm)



Description	Net Wt	SKU	Color	List Price
Evolution® 60 x 32-Inch Deep Soak® Drop-In Bathtub With EverClean® Combination Spa System	77 lb 35.0 kg	2422V418C.020	White	4,444

Required Components:

Deep Soak® Max Bathtub Drain	6 lb	1599205.002	Polished Chrome	195
	2.7 kg	1599205.020	White	195
		1599205.295	Brushed Nickel	312

Optional Components:

Universal Tile Bead Kit	2 lb 1.0 kg	751755-100	White	79
Universal Tile Bead Adhesive (Bulk)	21 lb 9.5 kg	9330014		52



Evolution® 60 x 36-Inch Deep Soak® Drop-In Bathtub With EverClean® Combination Spa System

- Transitional style hydromassage whirlpool and air bath with EverClean® plumbing system
- Eight multi-directional and flow-adjustable Clean Jets™ including two in the lumbar area
- Single speed pump/motor with side mounted on/off air switch
- Two silent air volume controls
- Chrome air jets with automatic water purge and timer
- Variable speed air blower with heater
- High-quality acrylic with fiberglass reinforcement
- Easy-to-clean high-gloss surface that's UV stable and stain resistant
- Dual molded-in armrests
- Pre-leveled tub bottom for easier installation
- Drop-in or undermount option
- Must order Deep Soak® Max Drain
- Quick connect Safe-T Heater connection system (must order Safe-T Heater separately)
- Limited lifetime warranty

Nominal Dimensions:

60 in x 36 in x 21-1/2 in (1524 mm x 914 mm x 546 mm)



Description	Net Wt	SKU	Color	List Price
Evolution® 60 x 36-Inch Deep Soak® Drop-In Bathtub With EverClean® Combination Spa System	111 lb 50.4 kg	2771V418C.020	White	4,725

Required Components:

Deep Soak® Max Bathtub Drain	6 lb	1599205.002	Polished Chrome	195
	2.7 kg	1599205.020	White	195
		1599205.295	Brushed Nickel	312

Optional Components:

Universal Tile Bead Kit	2 lb 1.0 kg	751755-100	White	79
Universal Tile Bead Adhesive (Bulk)	21 lb 9.5 kg	9330014		52



Evolution® 72 x 36-Inch Deep Soak® Bathtub With EverClean® Combination Spa System

- Transitional style hydromassage whirlpool and air bath with EverClean® plumbing system
- Ten multi-directional and flow-adjustable Clean Jets™ including two in the lumbar area
- Single speed pump/motor with side mounted on/off air switch
- Two silent air volume controls
- High-quality acrylic with fiberglass reinforcement
- Easy to clean high-gloss surface that's UV stable and stain resistant
- Dual molded-in armrests
- Pre-leveled tub bottom for easier installation
- Drop-in or undermount option
- Must order Deep Soak® Max Drain
- Quick connect Safe-T Heater connection system (must order Safe-T Heater separately)
- Limited lifetime warranty

Nominal Dimensions:

72 in x 36 in x 21-1/4 in (1828 mm x 914 mm x 539 mm)



Description	Net Wt	SKU	Color	List Price
Evolution® 72 x 36-Inch Deep Soak® Bathtub With EverClean® Combination Spa System	135 lb 61.3 kg	7236V418C.020	White	5,316

Required Components:

Deep Soak® Max Bathtub Drain	6 lb	1599205.002	Polished Chrome	195
	2.7 kg	1599205.020	White	195
		1599205.295	Brushed Nickel	312

Optional Components:

Universal Tile Bead Kit	2 lb 1.0 kg	751755-100	White	79
Universal Tile Bead Adhesive (Bulk)	21 lb 9.5 kg	9330014		52

Americast Engineered Steel A Remarkable Alternative to Cast Iron



Americast is American Standard's unique process that bonds a high quality porcelain enamel surface with an enameling grade steel and a molded reinforcement composite backing. Americast is durable and weighs less than cast iron so it costs less to install. It is engineered to create tubs of unequalled strength, durability and weight. This composite is similar to those used in aerospace and automotive industries, and provides consistent structural integrity along with sound dampening, heat insulation and protection against impact damage. Unlike anything on the market, Americast combines the best qualities of three different techniques in a process that provides beauty, safety and reliability in today's baths.

Americast Construction

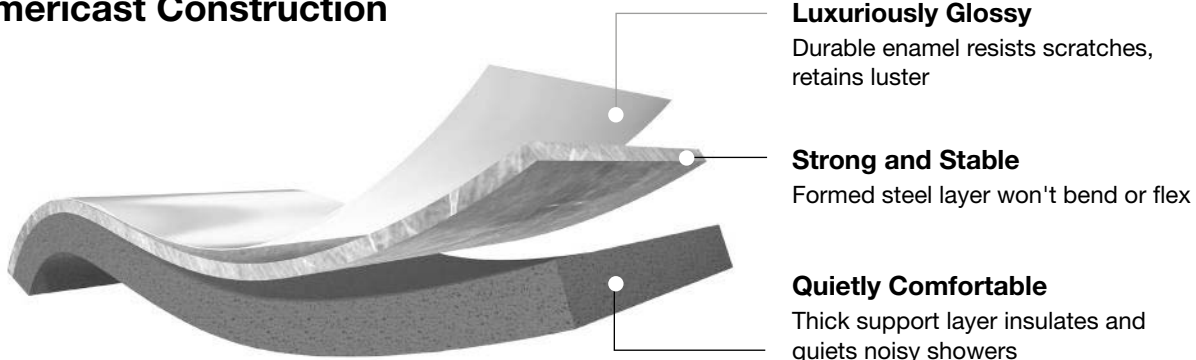

Luxuriously Glossy

Durable enamel resists scratches, retains luster

Strong and Stable

Formed steel layer won't bend or flex

Quietly Comfortable

Thick support layer insulates and quiets noisy showers

Better Heat Retention

The material composition and construction of Americast tubs provides better heat retention than cast iron or enameled steel tubs.

Lumbar Support and Beveled Headrest

Americast tubs are contoured for increased lower back support and improved head and neck comfort.

Luxury Ledge

This feature adds 4" (102 mm) of ledge space for increased shoulder and elbow room or a perfect spot for extra storage (optional feature).

StanSure™ Slip-Resistant Floor

- Full slip-resistant coverage increases bathroom safety
 - covers 56% more of the tub floor
- Easier to clean and stays cleaner longer
- Brighter, white textured surface that is more visually appealing

Tile Edge

This oversized flange ensures more tile/tub overlap, and decreases the chance of water reaching and damaging drywall or structural timbers. Best of all, it is designed not to interfere with normal tile application, or require any extra time to install.

Americast Meets Code

Americast Bathtubs and Whirlpools conform to industry specifications including:

- ASTM F462 Slip Resistance
- ANSI Z 124.1 Ignition Test
- All whirlpool models are UL listed as hydromassage units



Cambridge® Americast® 60 x 32-Inch Integral Apron Bathtub With Right-Hand Outlet

- Americast® engineered steel with glossy porcelain finish
- Full Stansure™ slip-resistant floor surface
- Recessed bath with integral apron
- Integral 3-sided tile/water retention flange
- Integral lumbar support with beveled headrest
- Pre-leveled tub bottom for easier installation
- ADA compliant
- 10-year warranty

Nominal Dimensions:

60 in x 32 in x 17-3/4 in (1524 mm x 812 mm x 450 mm)



Description	Net Wt	SKU	Color	List Price
Cambridge® Americast® 60 x 32-Inch Integral Apron Bathtub With Right-Hand Outlet	118 lb	2461002.011	Arctic	1,650
	53.6 kg	2461002.020	White	1,650

Required Components:

Bathtub Drain	6 lb 3.1 kg	1583470.002	Polished Chrome	198
		1583470.011	Arctic	338
		1583470.020	White	338
		1583470.295	Brushed Nickel	338
Deep Soak® Bathtub Drain	2 lb 1.0 kg	1640305.002	Polished Chrome	174
		1640305.011	Arctic	234
		1640305.020	White	195
		1640305.295	Brushed Nickel	312



Cambridge® Americast® 60 x 32-Inch Integral Apron Bathtub With Left-Hand Outlet

- Americast® engineered steel with glossy porcelain finish
- Full Stansure™ slip-resistant floor surface
- Recessed bath with integral apron
- Integral 3-sided tile/water retention flange
- Integral lumbar support with beveled headrest
- Pre-leveled tub bottom for easier installation
- ADA compliant
- 10-year warranty

Nominal Dimensions:

60 in x 32 in x 17-3/4 in (1524 mm x 812 mm x 450 mm)



Description	Net Wt	SKU	Color	List Price
Cambridge® Americast® 60 x 32-Inch Integral Apron Bathtub With Left-Hand Outlet	118 lb	2460002.011	Arctic	1,650
	53.6 kg	2460002.020	White	1,650

Required Components:

Bathtub Drain	6 lb 3.1 kg	1583470.002	Polished Chrome	198
		1583470.011	Arctic	338
		1583470.020	White	338
		1583470.295	Brushed Nickel	338
Deep Soak® Bathtub Drain	2 lb 1.0 kg	1640305.002	Polished Chrome	174
		1640305.011	Arctic	234
		1640305.020	White	195
		1640305.295	Brushed Nickel	312



Princeton® Americast® 60 x 30-Inch Integral Apron Bathtub With Right-Hand Outlet

- Americast® engineered steel with glossy porcelain finish
- Full Stansure™ slip-resistant floor surface
- Recessed bath with integral apron
- Integral 3-sided tile/water retention flange
- Integral lumbar support with beveled headrest
- Pre-leveled tub bottom for easier installation
- ADA compliant
- 10-year warranty

Nominal Dimensions:

60 in x 30 in x 14-15/16 in (1524 mm x 762 mm x 379 mm)



Description	Net Wt	SKU	Color	List Price
Princeton® Americast® 60 x 30-Inch Integral Apron Bathtub With Right-Hand Outlet	88 lb 40.0 kg	2391202.011	Arctic	646
		2391202.020	White	646
		2391202.021	Bone	842
		2391202.222	Linen	930

Required Components:

Bathtub Drain	6 lb 3.1 kg	1583470.002	Polished Chrome	198
		1583470.011	Arctic	338
		1583470.020	White	338
		1583470.295	Brushed Nickel	338
Deep Soak® Bathtub Drain	2 lb 1.0 kg	1640305.002	Polished Chrome	174
		1640305.011	Arctic	234
		1640305.020	White	195
		1640305.021	Bone	193
		1640305.222	Linen	234
		1640305.295	Brushed Nickel	312



Princeton® Americast® 60 x 30-Inch Integral Apron Bathtub Right-Hand Outlet With Integral Drain

- Americast® engineered steel with glossy porcelain finish
- Full Stansure™ slip-resistant floor surface
- Factory installed overflow that saves time & money
- Recessed bath with integral apron
- Integral 3-sided tile/water retention flange
- Integral lumbar support with beveled headrest
- Pre-leveled tub bottom for easier installation
- Drain stopper and escutcheon included
- 10-year warranty

Nominal Dimensions:

60 in x 30 in x 14-15/16 in (1524 mm x 762 mm x 379 mm)

Description	Net Wt	SKU	Color	List Price
Princeton® Americast® 60 x 30-Inch Integral Apron Bathtub Right-Hand Outlet With Integral Drain	88 lb 40.0 kg	2391202ICH.020	White	713

Separate Components:

Integral Overflow Oval Escutcheon	0 lb 0.0 kg	▷791165-0020A	Polished Chrome	26
ICH Pressure Test Drain Kit	0 lb 0.1 kg	▷791363-0070A	No Finish	34
Stopper and Drain Assembly	0 lb 0.3 kg	791474-0020A	Polished Chrome	97



Princeton® Americast® 60 x 30-Inch Integral Apron Bathtub With Left-Hand Outlet

- Americast® engineered steel with glossy porcelain finish
- Full Stansure™ slip-resistant floor surface
- Recessed bath with integral apron
- Integral 3-sided tile/water retention flange
- Integral lumbar support with beveled headrest
- Pre-leveled tub bottom for easier installation
- ADA compliant
- 10-year warranty

Nominal Dimensions:

60 in x 30 in x 14 in (1524 mm x 762 mm x 355 mm)



Description	Net Wt	SKU	Color	List Price
Princeton® Americast® 60 x 30-Inch Integral Apron Bathtub With Left-Hand Outlet	88 lb 40.0 kg	2390202.011	Arctic	646
		2390202.020	White	646
		2390202.021	Bone	842
		2390202.222	Linen	930

Required Components:

Bathtub Drain	6 lb 3.1 kg	1583470.002	Polished Chrome	198
		1583470.011	Arctic	338
		1583470.020	White	338
		1583470.295	Brushed Nickel	338
Deep Soak® Bathtub Drain	2 lb 1.0 kg	1640305.002	Polished Chrome	174
		1640305.011	Arctic	234
		1640305.020	White	195
		1640305.021	Bone	193
		1640305.222	Linen	234
		1640305.295	Brushed Nickel	312



Princeton® Americast® 60 x 30-Inch Integral Apron Bathtub Left-Hand Outlet With Integral Drain

- Americast® engineered steel with glossy porcelain finish
- Full Stansure™ slip-resistant floor surface
- Factory installed overflow that saves time & money
- Recessed bath with integral apron
- Integral 3-sided tile/water retention flange
- Integral lumbar support with beveled headrest
- Pre-leveled tub bottom for easier installation
- Drain stopper and escutcheon included
- 10-year warranty

Nominal Dimensions:

60 in x 30 in x 14-15/16 in (1524 mm x 762 mm x 379 mm)

Description	Net Wt	SKU	Color	List Price
Princeton® Americast® 60 x 30-Inch Integral Apron Bathtub Left-Hand Outlet With Integral Drain	89 lb 40.4 kg	2390202ICH.020	White	713

Separate Components:

Integral Overflow Oval Escutcheon	0 lb 0.0 kg	▷791165-0020A	Polished Chrome	26
ICH Pressure Test Drain Kit	0 lb 0.1 kg	▷791363-0070A	No Finish	34
Stopper and Drain Assembly	0 lb 0.3 kg	791474-0020A	Polished Chrome	97

▷ Parts Program (Non-Premier)



Princeton® Americast® 60 x 30-Inch Integral Apron Bathtub Above Floor Rough with Right-Hand Outlet

- Americast® engineered steel with glossy porcelain finish
- Full Stansure™ slip-resistant floor surface
- Above floor rough installation
- Recessed bath with integral apron
- Integral 3-sided tile/water retention flange
- Integral lumbar support with beveled headrest
- Pre-leveled tub bottom for easier installation
- ADA compliant
- 10-year warranty

Nominal Dimensions:

60 in x 30 in x 18-7/16 in (1524 mm x 762 mm x 468 mm)



Description	Net Wt	SKU	Color	List Price
Princeton® Americast® 60 x 30-Inch Integral Apron Bathtub Above Floor Rough with Right-Hand Outlet	92 lb 41.8 kg	2393202.020	White	982

Required Components:

Bathtub Drain	6 lb 3.1 kg	1583470.002	Polished Chrome	198
		1583470.020	White	338
		1583470.295	Brushed Nickel	338
Deep Soak® Bathtub Drain	2 lb 1.0 kg	1640305.002	Polished Chrome	174
		1640305.020	White	195
		1640305.295	Brushed Nickel	312



Princeton® Americast® 60 x 30-Inch Integral Apron Bathtub Above Floor Rough Right-Hand Outlet with Integral Drain

- Americast® engineered steel with glossy porcelain finish
- Full Stansure™ slip-resistant floor surface
- Factory installed overflow that saves time & money
- Above floor rough installation
- Recessed bath with integral apron
- Integral 3-sided tile/water retention flange
- Integral lumbar support with beveled headrest
- Pre-leveled tub bottom for easier installation
- Drain stopper and escutcheon included
- 10-year warranty

Nominal Dimensions:

60 in x 30 in x 18-7/16 in (1524 mm x 762 mm x 468 mm)

Description	Net Wt	SKU	Color	List Price
Princeton® Americast® 60 x 30-Inch Integral Apron Bathtub Above Floor Rough Right-Hand Outlet with Integral Drain	93 lb 42.2 kg	2393202ICH.020	White	1,073

Separate Components:

Integral Overflow Oval Escutcheon	0 lb 0.0 kg	▷791165-0020A	Polished Chrome	26
ICH Pressure Test Drain Kit	0 lb 0.1 kg	▷791363-0070A	No Finish	34
Stopper and Drain Assembly	0 lb 0.3 kg	791474-0020A	Polished Chrome	97



Princeton® Americast® 60 x 30-Inch Integral Apron Bathtub Above Floor Rough with Left-Hand Outlet

- Americast® engineered steel with glossy porcelain finish
- Full Stansure™ slip-resistant floor surface
- Above floor rough installation
- Recessed bath with integral apron
- Integral 3-sided tile/water retention flange
- Integral lumbar support with beveled headrest
- Pre-leveled tub bottom for easier installation
- ADA compliant
- 10-year warranty

Nominal Dimensions:

60 in x 30 in x 18-7/16 in (1524 mm x 762 mm x 468 mm)



Description	Net Wt	SKU	Color	List Price
Princeton® Americast® 60 x 30-Inch Integral Apron Bathtub Above Floor Rough with Left-Hand Outlet	92 lb 41.8 kg	2392202.020	White	982

Required Components:

Bathtub Drain	6 lb 3.1 kg	1583470.002	Polished Chrome	198
		1583470.020	White	338
		1583470.295	Brushed Nickel	338
Deep Soak® Bathtub Drain	2 lb 1.0 kg	1640305.002	Polished Chrome	174
		1640305.020	White	195
		1640305.295	Brushed Nickel	312



Princeton® Americast® 60 x 30-Inch Integral Apron Bathtub Above Floor Rough Left-Hand Outlet with Integral Drain

- Americast® engineered steel with glossy porcelain finish
- Full Stansure™ slip-resistant floor surface
- Factory installed overflow that saves time & money
- Above floor rough installation
- Recessed bath with integral apron
- Integral 3-sided tile/water retention flange
- Integral lumbar support with beveled headrest
- Pre-leveled tub bottom for easier installation
- Drain stopper and escutcheon included
- 10-year warranty

Nominal Dimensions:

60 in x 30 in x 18-7/16 in (1524 mm x 762 mm x 468 mm)

Description	Net Wt	SKU	Color	List Price
Princeton® Americast® 60 x 30-Inch Integral Apron Bathtub Above Floor Rough Left-Hand Outlet with Integral Drain	93 lb 42.2 kg	2392202ICH.020	White	1,073

Separate Components:

Integral Overflow Oval Escutcheon	0 lb 0.0 kg	▷791165-0020A	Polished Chrome	26
ICH Pressure Test Drain Kit	0 lb 0.1 kg	▷791363-0070A	No Finish	34
Stopper and Drain Assembly	0 lb 0.3 kg	791474-0020A	Polished Chrome	97



Princeton® Americast® 60 x 34-Inch Integral Apron Bathtub Right-Hand Outlet with Luxury Ledge

- Americast® engineered steel with glossy porcelain finish
- Full Stansure™ slip-resistant floor surface
- Extra-wide ledge for toiletries
- Recessed bath with integral apron
- Integral 3-sided tile/water retention flange
- Integral lumbar support with beveled headrest
- Pre-leveled tub bottom for easier installation
- ADA compliant
- 10-year warranty

Nominal Dimensions:

60 in x 34 in x 14-15/16 in (1524 mm x 863 mm x 379 mm)



Description	Net Wt	SKU	Color	List Price
Princeton® Americast® 60 x 34-Inch Integral Apron Bathtub Right-Hand Outlet with Luxury Ledge	94 lb 42.7 kg	2395202.020	White	760

Required Components:

Bathtub Drain	6 lb 3.1 kg	1583470.002	Polished Chrome	198
		1583470.020	White	338
		1583470.295	Brushed Nickel	338
Deep Soak® Bathtub Drain	2 lb 1.0 kg	1640305.002	Polished Chrome	174
		1640305.020	White	195
		1640305.295	Brushed Nickel	312



Princeton® Americast® 60 x 34-Inch Integral Apron Bathtub Right-Hand Outlet Luxury Ledge with Integral Drain

- Americast® engineered steel with glossy porcelain finish
- Full Stansure™ slip-resistant floor surface
- Extra-wide ledge for toiletries
- Factory installed overflow that saves time & money
- Recessed bath with integral apron
- Integral 3-sided tile/water retention flange
- Integral lumbar support with beveled headrest
- Pre-leveled tub bottom for easier installation
- Drain stopper and escutcheon included
- 10-year warranty

Nominal Dimensions:

60 in x 34 in x 14-15/16 in (1524 mm x 863 mm x 379 mm)

Description	Net Wt	SKU	Color	List Price
Princeton® Americast® 60 x 34-Inch Integral Apron Bathtub Right-Hand Outlet Luxury Ledge with Integral Drain	95 lb 43.1 kg	2395202ICH.020	White	851

Separate Components:

Integral Overflow Oval Escutcheon	0 lb 0.0 kg	▷791165-0020A	Polished Chrome	26
ICH Pressure Test Drain Kit	0 lb 0.1 kg	▷791363-0070A	No Finish	34
Stopper and Drain Assembly	0 lb 0.3 kg	791474-0020A	Polished Chrome	97



Princeton® Americast® 60 x 34-Inch Integral Apron Bathtub Left-Hand Outlet With Luxury Ledge

- Americast® engineered steel with glossy porcelain finish
- Full Stansure™ slip-resistant floor surface
- Recessed bath with integral apron
- Integral 3-sided tile/water retention flange
- Pre-leveled tub bottom for easier installation
- Integral lumbar support with beveled headrest
- ADA compliant
- 10-year warranty

Nominal Dimensions:

60 in x 34 in x 14-15/16 in (1524 mm x 863 mm x 379 mm)



Description	Net Wt	SKU	Color	List Price
Princeton® Americast® 60 x 34-Inch Integral Apron Bathtub Left-Hand Outlet With Luxury Ledge	94 lb 42.7 kg	2394202.020	White	760

Required Components:

Bathtub Drain	6 lb 3.1 kg	1583470.002	Polished Chrome	198
		1583470.020	White	338
		1583470.295	Brushed Nickel	338
Deep Soak® Bathtub Drain	2 lb 1.0 kg	1640305.002	Polished Chrome	174
		1640305.020	White	195
		1640305.295	Brushed Nickel	312



Princeton® Americast® 60 x 34-Inch Integral Apron Bathtub Left-Hand Outlet Luxury Ledge with Integral Drain

- Americast® engineered steel with glossy porcelain finish
- Full Stansure™ slip-resistant floor surface
- Extra-wide ledge for toiletries
- Factory installed overflow that saves time & money
- Recessed bath with integral apron
- Integral 3-sided tile/water retention flange
- Integral lumbar support with beveled headrest
- Pre-leveled tub bottom for easier installation
- Drain stopper and escutcheon included
- 10-year warranty

Nominal Dimensions:

60 in x 34 in x 14 in (1524 mm x 863 mm x 355 mm)

Description	Net Wt	SKU	Color	List Price
Princeton® Americast® 60 x 34-Inch Integral Apron Bathtub Left-Hand Outlet Luxury Ledge with Integral Drain	95 lb 43.1 kg	2394202ICH.020	White	851

Separate Components:

Integral Overflow Oval Escutcheon	0 lb 0.0 kg	▷791165-0020A	Polished Chrome	26
ICH Pressure Test Drain Kit	0 lb 0.1 kg	▷791363-0070A	No Finish	34
Stopper and Drain Assembly	0 lb 0.3 kg	791474-0020A	Polished Chrome	97

▷ Parts Program (Non-Premier)



Princeton® Americast® 60 x 34-Inch Integral Apron Bathtub Above Floor Rough Right-Hand Outlet with Luxury Ledge

- Americast® engineered steel with glossy porcelain finish
- Full Stansure™ slip-resistant floor surface
- Above floor rough installation
- Extra-wide ledge for toiletries
- Recessed bath with integral apron
- Integral 3-sided tile/water retention flange
- Integral lumbar support with beveled headrest
- Pre-leveled tub bottom for easier installation
- ADA compliant
- 10-year warranty

Nominal Dimensions:

60 in x 34 in x 18-7/16 in (1524 mm x 863 mm x 468 mm)



Description	Net Wt	SKU	Color	List Price
Princeton® Americast® 60 x 34-Inch Integral Apron Bathtub Above Floor Rough Right-Hand Outlet with Luxury Ledge	100 lb 45.4 kg	2397202.020	White	1,259

Required Components:

Bathtub Drain	6 lb 3.1 kg	1583470.002	Polished Chrome	198
		1583470.020	White	338
		1583470.295	Brushed Nickel	338
Deep Soak® Bathtub Drain	2 lb 1.0 kg	1640305.002	Polished Chrome	174
		1640305.020	White	195
		1640305.295	Brushed Nickel	312



Princeton® Americast® 60 x 34-Inch Integral Apron Bathtub Above Floor Rough Right-Hand Outlet Luxury Ledge with Integral Drain

- Americast® engineered steel with glossy porcelain finish
- Full Stansure™ slip-resistant floor surface
- Above floor rough installation
- Extra-wide ledge for toiletries
- Recessed bath with integral apron
- Integral 3-sided tile/water retention flange
- Integral lumbar support with beveled headrest
- Pre-leveled tub bottom for easier installation
- ADA compliant
- 10 Year Warranty

Nominal Dimensions:

60 in x 34 in x 17.5 in (1524 mm x 863 mm x 444 mm)

Description	Net Wt	SKU	Color	List Price
Princeton® Americast® 60 x 34-Inch Integral Apron Bathtub Above Floor Rough Right-Hand Outlet Luxury Ledge with Integral Drain	101 lb 45.9 kg	2397202ICH.020	White	1,397

Separate Components:

Integral Overflow Oval Escutcheon	0 lb 0.0 kg	▷791165-0020A	Polished Chrome	26
ICH Pressure Test Drain Kit	0 lb 0.1 kg	▷791363-0070A	No Finish	34
Stopper and Drain Assembly	0 lb 0.3 kg	791474-0020A	Polished Chrome	97

▷ Parts Program (Non-Premier)



Princeton® Americast® 60 x 34-Inch Integral Apron Bathtub Above Floor Rough Left-Hand Outlet with Luxury Ledge

- Americast® engineered steel with glossy porcelain finish
- Full Stansure™ slip-resistant floor surface
- Above floor rough installation
- Extra-wide ledge for toiletries
- Recessed bath with integral apron
- Integral 3-sided tile/water retention flange
- Integral lumbar support with beveled headrest
- Pre-leveled tub bottom for easier installation
- ADA compliant
- 10-year warranty

Nominal Dimensions:

60 in x 34 in x 18-7/16 in (1524 mm x 863 mm x 468 mm)



Description	Net Wt	SKU	Color	List Price
Princeton® Americast® 60 x 34-Inch Integral Apron Bathtub Above Floor Rough Left-Hand Outlet with Luxury Ledge	100 lb 45.4 kg	2396202.020	White	1,259

Required Components:

Bathtub Drain	6 lb 3.1 kg	1583470.002	Polished Chrome	198
		1583470.020	White	338
		1583470.295	Brushed Nickel	338
Deep Soak® Bathtub Drain	2 lb 1.0 kg	1640305.002	Polished Chrome	174
		1640305.020	White	195
		1640305.295	Brushed Nickel	312



Princeton® Americast® 60 x 34-Inch Integral Apron Bathtub Above Floor Rough Left-Hand Outlet Luxury Ledge with Integral Drain

- Americast® engineered steel with glossy porcelain finish
- Full Stansure™ slip-resistant floor surface
- Above floor rough installation
- Extra-wide ledge for toiletries
- Recessed bath with integral apron
- Integral 3-sided tile/water retention flange
- Integral lumbar support with beveled headrest
- Pre-leveled tub bottom for easier installation
- Drain stopper and escutcheon included
- 10-year warranty

Nominal Dimensions:

60 in x 34 in x 17.5 in (1524 mm x 863 mm x 444 mm)

Description	Net Wt	SKU	Color	List Price
Princeton® Americast® 60 x 34-Inch Integral Apron Bathtub Above Floor Rough Left-Hand Outlet Luxury Ledge with Integral Drain	101 lb 45.9 kg	2396202ICH.020	White	1,397

Separate Components:

Integral Overflow Oval Escutcheon	0 lb 0.0 kg	▷791165-0020A	Polished Chrome	26
ICH Pressure Test Drain Kit	0 lb 0.1 kg	▷791363-0070A	No Finish	34
Stopper and Drain Assembly	0 lb 0.3 kg	791474-0020A	Polished Chrome	97

▷ Parts Program (Non-Premier)



New Salem™ 60 x 30-Inch Integral Apron Bathtub With Right-Hand Outlet

- Transitional style recessed bath with integral apron
- Glossy porcelain finish
- Full Stansure™ slip-resistant floor surface
- Above floor rough installation
- Integral 3-sided tile/water retention flange
- 1-year limited warranty

Nominal Dimensions:

60 in x 30 in x 14-1/16 in (1524 mm x 762 mm x 357 mm)



Description	Net Wt	SKU	Color	List Price
New Salem™ 60 x 30-Inch Integral Apron Bathtub With Right-Hand Outlet	66 lb 30.3 kg	0255112.020	White	642

Required Components:

Bathtub Drain	6 lb 3.1 kg	1583470.002	Polished Chrome	198
		1583470.020	White	338
		1583470.295	Brushed Nickel	338
Deep Soak® Bathtub Drain	2 lb 1.0 kg	1640305.002	Polished Chrome	174
		1640305.020	White	195
		1640305.295	Brushed Nickel	312



New Salem™ 60 x 30-Inch Integral Apron Bathtub With Left-Hand Outlet

- Recessed bath with integral apron
- Glossy porcelain finish
- Full Stansure™ slip-resistant floor surface
- Above floor rough installation
- Integral 3-sided tile/water retention flange
- 1-year limited warranty

Nominal Dimensions:

60 in x 30 in x 14-1/16 in (1524 mm x 762 mm x 357 mm)



Description	Net Wt	SKU	Color	List Price
New Salem™ 60 x 30-Inch Integral Apron Bathtub With Left-Hand Outlet	66 lb 30.3 kg	0255212.020	White	642

Required Components:

Bathtub Drain	6 lb 3.1 kg	1583470.002	Polished Chrome	198
		1583470.020	White	338
		1583470.295	Brushed Nickel	338
Deep Soak® Bathtub Drain	2 lb 1.0 kg	1640305.002	Polished Chrome	174
		1640305.020	White	195
		1640305.295	Brushed Nickel	312



New Solar® 60 x 30-Inch Integral Apron Bathtub Above Floor Rough With Right-Hand Outlet

- Transitional style recessed bath with integral apron
- Glossy porcelain finish
- Full Stansure™ slip-resistant floor surface
- Above floor rough installation
- Integral 3-sided tile/water retention flange
- 1-year limited warranty

Nominal Dimensions:

60 in x 30 in x 16-5/8 in (1524 mm x 762 mm x 422 mm)



Description	Net Wt	SKU	Color	List Price
New Solar® 60 x 30-Inch Integral Apron Bathtub Above Floor Rough With Right-Hand Outlet	71 lb 32.6 kg	0263112.020	White	685

Required Components:

Bathtub Drain	6 lb 3.1 kg	1583470.002	Polished Chrome	198
		1583470.020	White	338
		1583470.295	Brushed Nickel	338
Deep Soak® Bathtub Drain	2 lb 1.0 kg	1640305.002	Polished Chrome	174
		1640305.020	White	195
		1640305.295	Brushed Nickel	312



New Solar® 60 x 30-Inch Integral Apron Bathtub Above Floor Rough With Left-Hand Outlet

- Recessed bath with integral apron
- Glossy porcelain finish
- Full Stansure™ slip-resistant floor surface
- Above floor rough installation
- Integral 3-sided tile/water retention flange
- 1-year limited warranty

Nominal Dimensions:

60 in x 30 in x 16-5/8 in (1524 mm x 762 mm x 422 mm)



Description	Net Wt	SKU	Color	List Price
New Solar® 60 x 30-Inch Integral Apron Bathtub Above Floor Rough With Left-Hand Outlet	71 lb 32.6 kg	0263212.020	White	685

Required Components:

Bathtub Drain	6 lb 3.1 kg	1583470.002	Polished Chrome	198
		1583470.020	White	338
		1583470.295	Brushed Nickel	338
Deep Soak® Bathtub Drain	2 lb 1.0 kg	1640305.002	Polished Chrome	174
		1640305.020	White	195
		1640305.295	Brushed Nickel	312

Shower and Tub Doors

The perfect shower or bathtub door is one that functions perfectly in your space and complements the style of your bathroom. The **American Standard Collection** of on-trend, quality-crafted doors are designed to provide outstanding performance and long-lasting beauty in today's home.



Shower and Tub Doors Overview

Frameless/Semi-Frameless Shower Doors

Sleek and sophisticated with frameless glass edges

Top-roller Sliding Door for Shower

- Both panels slide
- 3/8" or 1/4"-thick clear glass
- Easy to clean glass coating



Swing Door and Panel for Shower

- 3/8"-thick clear glass
- Easy to clean glass coating
- One swing door panel, one stationary panel



Shower Screen

- Stationary panel
- 3/8"-thick clear glass



Semi-Frameless Doors

Clean lines with outer frame support and frameless glass edges

- 1/4" tempered glass
- Select from up to three frame finishes
- Through-the-glass handles
- Easy to clean/open bottom track

Sliding Doors for Bath and Shower



Swing Door for Shower



Swing Door and Panel for Shower



Framed Doors

Both outer and glass edges feature frame support

Sliding Doors for Bath and Shower

- Easy to clean bottom track system
- Two towel bars
- Select from three frame finishes

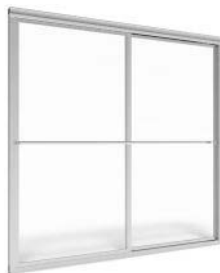

Neo-Angle

- Perfect shower solution for small bathrooms
- Reversible on install for a left or right swing
- Drip rail system keeps water in shower
- Select from three frame finishes



Swing

- Reversible on install for a left or right swing
- Multiple glass styles
- Silver frame finish



How to Measure the Perfect Shower Door

1 MEASURE

Walls must be finished before measuring to get an accurate dimension for installation. Measure in 3 places to determine if walls are plumb.

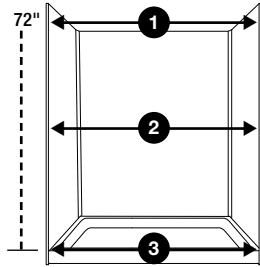

- 1 TOP**
72" up from the base of shower
- 2 MIDDLE**
Halfway between base/top
- 3 BOTTOM**
Shower base/threshold

Use a level to check for plumb walls. If any of your measurements are not the same, make sure to look for a door that allows for out-of-plumb adjustability

2 Choose Your CONFIGURATION

Alcove



Made to fit a single opening in an alcove with 3 walls.

Corner



Made to fit a corner configuration where the shower base is touching 2 walls.

Neo-Angle

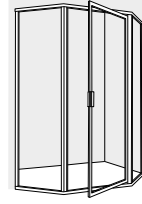

Made to fit a corner configuration where the shower base is angled with 3 sides.

3 Choose Your DOOR TYPE

Pivot

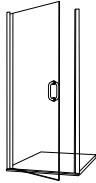

The door swings in and out for entry and exit

Sliding

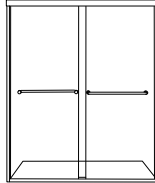

Sliding doors slide left or right along a bottom track. Some sliding doors are bypass, where both can open and pass one another. Some also feature one door that slides open and one door that is fixed.

Panel

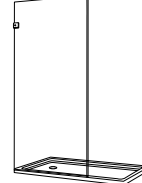

Some people prefer a simple glass panel that covers most of the shower base or tub, with no actual door to pass through.

4 Choose Your FRAME

Framed

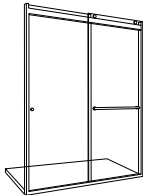

Features a frame around the door and opening of each panel.

Semi-Frameless

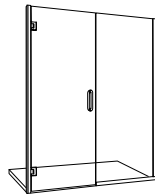

Framing is featured around the sides of the piece, but not around the actual glass panel.

Frameless

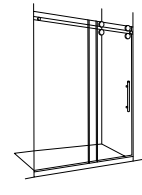

Minimal framing for a simplistic look.

5 Choose Your GLASS (Shower door glass patterns)



Clear 400



Rain 422



Hammered 436



Silver 213



Brushed Nickel 006



ORB 224

6 Choose Your FINISH (Shower door frame finishes)

Please see color swatches on inside front cover.

ORB - Oil Rubbed Bronze



72-Inch Height Frameless Shower Door With Panel

- Frameless swing door and panel
- Easy-to-clean glass coating repels moisture and soap film
- Reversible for left or right installation
- 8" (203 mm) through-the-glass C-pull handle
- 3/8" (9 mm) thick clear safety-tempered glass
- Minimum 2-1/2" (64 mm) threshold width required
- Fits opening: 46-1/16" – 47-9/16" (1170 – 208 mm)
- 72" (1829 mm) height
- Clear glass

Nominal Dimensions:

48 in x 72 in (1219 mm x 3/8 in x 1828 mm)



Description	Net Wt	SKU	Color	List Price
72-Inch Height Frameless Shower Door With Panel	132 lb	AM00814400.006	Brushed Nickel	2,430
	59.9 kg	AM00814400.213	Silver Shine	1,869



72-Inch Height Frameless Shower Door With Panel

- Frameless swing door and panel
- Easy-to-clean glass coating repels moisture and soap film
- Reversible for left or right installation
- 8" (203 mm) through-the-glass C-pull handle
- 3/8" (9 mm) thick clear safety-tempered glass
- Minimum 2-1/2" (64 mm) threshold width required
- Fits opening: 58-1/16" – 59-9/16" (1475 – 1513 mm)
- 72" Height

Nominal Dimensions:

60 in x 72 in (1524 mm x 3/8 in x 1828 mm)



Description	Net Wt	SKU	Color	List Price
72-Inch Height Frameless Shower Door With Panel	161 lb	AM00812400.006	Brushed Nickel	2,496
	73.1 kg	AM00812400.213	Silver Shine	1,920



76-Inch Height Frameless Shower Screen

- Frameless shower screen
- Easy-to-clean glass coating helps prevent water spots and film
- Stationary panel – does not swing
- Not intended to span entire length of shower
- Leaves open space to enter 48" – 60" (1219 – 1524 mm) shower
- Length: 24" (610 mm) for 48" (1219 mm) opening
- 3/8" (9 mm) thick clear safety-tempered glass
- Minimum 1" (25 mm) threshold width required
- 76" (1930 mm) height
- Clear glass

Nominal Dimensions:

24 in x 76 in (609 mm x 13/16 in x 1930 mm)



Description	Net Wt	SKU	Color	List Price
76-Inch Height Frameless Shower Screen	86 lb 39.0 kg	AM00824400.213	Silver Shine	656



76-Inch Height Frameless Shower Screen

- Frameless shower screen
- Easy-to-clean glass coating helps prevent water spots and film
- Stationary panel – does not swing
- Not intended to span entire length of shower
- Leaves open space to enter 48" – 60" (1219 – 1524 mm) shower
- Length: 30" (762 mm) for 60" (1524 mm) opening
- 3/8" (9 mm) thick clear safety-tempered glass
- Minimum 1" (25 mm) threshold width required
- 76" (1930 mm) height
- Clear glass

Nominal Dimensions:

30 in x 76 in (762 mm x 13/16 in x 1930 mm)



Description	Net Wt	SKU	Color	List Price
76-Inch Height Frameless Shower Screen	70 lb 32.1 kg	AM00830400.213	Silver Shine	874



70-Inch Height Semi-Frameless Top-Roller Sliding Shower Door

- Top-roller shower door
- Easy-to-clean glass coating repels moisture and soap film
- Both panels slide
- Reversible installation for left or right entry
- Exterior through-the-glass towel bar and back-to-back pull knob
- ¼" (6 mm) clear safety-tempered glass
- Minimum 2-¾" (70 mm) threshold width required
- Fits opening: 44" – 48" (1118 – 1219 mm)
- 76" (1930 mm) height
- Clear glass

Nominal Dimensions:

48 in x 70 in (1219 mm x 2-11/16 in x 1778 mm)



Description	Net Wt	SKU	Color	List Price
70-Inch Height Semi-Frameless Top-Roller Sliding Shower Door	105 lb	AM00821400.006	Brushed Nickel	1,716
	47.7 kg	AM00821400.213	Silver Shine	1,319



70-Inch Height Semi-Frameless Top-Roller Sliding Shower Door

- Top-roller shower door
- Easy-to-clean glass coating repels moisture and soap film
- Both panels slide
- Reversible installation for left or right entry
- Exterior through-the-glass towel bar and back-to-back pull knob
- ¼" (6 mm) clear safety-tempered glass
- Minimum 2-¾" (70 mm) threshold width required
- Fits opening: 56" – 60" (1422 – 1524 mm)
- 76" (1930 mm) height
- Clear glass

Nominal Dimensions:

60 in x 70 in (1524 mm x 2-11/16 in x 1778 mm)



Description	Net Wt	SKU	Color	List Price
70-Inch Height Semi-Frameless Top-Roller Sliding Shower Door	124 lb	AM00822400.006	Brushed Nickel	1,853
	56.3 kg	AM00822400.213	Silver Shine	1,426



76-Inch Height Semi-Frameless Top-Roller Sliding Shower Door

- Top-roller shower door
- Easy-to-clean glass coating repels moisture and soap film
- Both panels slide
- Reversible installation for left or right entry
- Exterior through-the-glass towel bar and back-to-back pull knob
- 3/8" (9 mm) safety tempered glass
- Minimum 2-¾" (70 mm) threshold width required
- Fits opening: 44" – 48" (1118 – 1219 mm)
- 76" (1930 mm) height
- Clear glass

Nominal Dimensions:

48 in x 76 in (1219 mm x 2-11/16 in x 1930 mm)



Description	Net Wt	SKU	Color	List Price
76-Inch Height Semi-Frameless Top-Roller Sliding Shower Door	152 lb	AM00810400.006	Brushed Nickel	2,465
	69.0 kg	AM00810400.213	Silver Shine	1,895



76-Inch Height Semi-Frameless Top-Roller Sliding Shower Door

- Top-roller shower door
- Easy-to-clean glass coating repels moisture and soap film
- Both panels slide
- Reversible installation for left or right entry
- Exterior through-the-glass towel bar and back-to-back pull knob
- 3/8" (9 mm) safety-tempered glass
- Minimum 2-3/4" (70 mm) threshold width required
- Fits opening: 56" – 60" (1422 – 1524 mm)
- 76" (1930 mm) height
- Clear glass

Nominal Dimensions:

60 in x 76 in (1524 mm x 2-11/16 in x 1930 mm)



Description	Net Wt	SKU	Color	List Price
76-Inch Height Semi-Frameless Top-Roller Sliding Shower Door	182 lb	AM00811400.006	Brushed Nickel	2,946
	82.6 kg	AM00811400.213	Silver Shine	2,266



76-Inch Height Semi-Frameless Swing Door With Panel

- Semi-frameless swing door and panel
- Easy-to-clean glass coating helps prevent water spots and film
- Door swings out only
- Clear drip system keeps the water inside shower
- 6" (152 mm) through-the-glass C-pull handle
- 1/4" (6 mm) safety-tempered glass
- Minimum 1-1/2" (38 mm) threshold width required
- Fits opening: 44-1/16" – 48" (1119 – 1219 mm)
- 76" (1930 mm) height
- Clear glass

Nominal Dimensions:

48 in x 76 in (1219 mm x 3/8 in x 1930 mm)



Description	Net Wt	SKU	Color	List Price
76-Inch Height Semi-Frameless Swing Door With Panel	86 lb	AM00817400.006	Brushed Nickel	2,181
	39.0 kg	AM00817400.213	Silver Shine	1,677



76-Inch Height Semi-Frameless Swing Door With Panel

- Semi-frameless swing door and panel
- Easy-to-clean glass coating helps prevent water spots and film
- Door swings out only
- Clear drip system keeps the water inside shower
- 6" (152 mm) through-the-glass C-pull handle
- 1/4" (6 mm) safety-tempered glass
- Minimum 1-1/2" (38 mm) threshold width required
- Fits opening: 56-1/16" – 60" (1424 – 1524 mm)
- 76" (1930 mm) height
- Clear glass

Nominal Dimensions:

60 in x 76 in (1524 mm x 3/8 in x 1930 mm)



Description	Net Wt	SKU	Color	List Price
76-Inch Height Semi-Frameless Swing Door With Panel	107 lb	AM00816400.006	Brushed Nickel	2,393
	48.6 kg	AM00816400.213	Silver Shine	1,842



76-Inch Height Semi-Frameless Swing Door

- Semi-frameless swing door
- Easy-to-clean glass coating helps prevent water spots and film
- Reversible for left to right installation
- Door swings out only
- 6" (152 mm) through-the-glass C-pull handle
- ¼" (6 mm) safety-tempered glass
- Minimum 2" (51 mm) threshold width required
- Fits opening: 35-1/16" – 36" (891 – 914 mm)
- 76" (1930 mm) height
- Clear glass

Nominal Dimensions:

36 in x 76 in (914 mm x 15/16 in x 1930 mm)



Description	Net Wt	SKU	Color	List Price
76-Inch Height Semi-Frameless Swing Door	69 lb	AM00819400.006	Brushed Nickel	1,549
	31.3 kg	AM00819400.213	Silver Shine	1,193



Euro 57-Inch Height Semi-Frameless Sliding Tub Door

- Semi-frameless European-designed doors
- Easy-to-clean open bottom track
- Simple out-of-square adjustment
- Heavy duty rounded header
- Towel bars pass through glass, 22" (559 mm)
- Smooth glide rollers
- ¼" (6 mm) safety-tempered glass
- Minimum 1-½" (38 mm) threshold width required
- Fits opening: 54-½" – 58-½" (1384 – 1486 mm)
- 57" (1448 mm) height
- Clear glass

Nominal Dimensions:

60 in x 57 in (1524 mm x 1/4 in x 1447 mm)

Description	Net Wt	SKU	Color	List Price
Euro 57-Inch Height Semi-Frameless Sliding Tub Door	85 lb 38.6 kg	AM00350400.006	Brushed Nickel	1,189
		AM00350400.213	Silver Shine	882
		AM00350400.224	Oil Rubbed Bronze	1,189



Euro 57-Inch Height Semi-Frameless Sliding Tub Door

- Semi-frameless European-designed doors
- Easy-to-clean open bottom track
- Simple out-of-square adjustment
- Heavy duty rounded header
- Towel bars pass through glass, 22" (559 mm)
- Smooth glide rollers
- ¼" (6 mm) safety-tempered glass
- Minimum 1-½" (38 mm) threshold width required
- Fits opening: 54-½" – 58-½" (1384 – 1486 mm)
- 57" (1448 mm) height
- Rain glass

Nominal Dimensions:

60 in x 57 in (1524 mm x 1/4 in x 1447 mm)

Description	Net Wt	SKU	Color	List Price
Euro 57-Inch Height Semi-Frameless Sliding Tub Door	82 lb 37.2 kg	AM00350422.006	Brushed Nickel	1,331
		AM00350422.213	Silver Shine	1,082
		AM00350422.224	Oil Rubbed Bronze	1,331

Images are for illustrative purposes only - exact features may vary.



Euro 70-Inch Height Semi-Frameless Sliding Shower Door

- Semi-frameless European-designed doors
- Easy-to-clean open bottom track
- Simple out-of-square adjustment
- Heavy duty rounded header
- Tubular bars pass through glass, 16-1/2" (419 mm)
- Smooth glide rollers
- 1/4" (6 mm) safety-tempered glass
- Minimum 1-1/2" (38 mm) threshold width required
- Fits opening: 43" – 47" (1092 – 1194 mm)
- 70" (1930 mm) height
- Clear glass

Nominal Dimensions:

48 in x 70 in (1219 mm x 1/4 in x 1778 mm)

Description	Net Wt	SKU	Color	List Price
Euro 70-Inch Height Semi-Frameless Sliding Shower Door	84 lb	AM00370400.006	Brushed Nickel	1,203
	38.1 kg	AM00370400.213	Silver Shine	968
		AM00370400.224	Oil Rubbed Bronze	1,203



Euro 70-Inch Height Semi-Frameless Sliding Shower Door

- Semi-frameless European-designed doors
- Easy-to-clean open bottom track
- Simple out-of-square adjustment
- Heavy duty rounded header
- Tubular bars pass through glass, 22" (559 mm)
- Smooth glide rollers
- 1/4" (6 mm) safety-tempered glass
- Minimum 1-1/2" (38 mm) threshold width required
- Fits opening: 54-1/2" – 58-1/2" (1384 – 1486 mm)
- 70" (1930 mm) height
- Clear glass

Nominal Dimensions:

60 in x 70 in (1524 mm x 1/4 in x 1778 mm)

Description	Net Wt	SKU	Color	List Price
Euro 70-Inch Height Semi-Frameless Sliding Shower Door	84 lb	AM00390400.006	Brushed Nickel	1,585
	38.1 kg	AM00390400.213	Silver Shine	1,221
		AM00390400.224	Oil Rubbed Bronze	1,585



Euro 70-Inch Height Semi-Frameless Sliding Shower Door

- Semi-frameless European-designed doors
- Easy-to-clean open bottom track
- Simple out-of-square adjustment
- Heavy duty rounded header
- Tubular bars pass through glass, 22" (559 mm)
- Smooth glide rollers
- 1/4" (6 mm) safety-tempered glass
- Minimum 1-1/2" (38 mm) threshold width required
- Fits opening: 54-1/2" – 58-1/2" (1384 – 1486 mm)
- 70" (1930 mm) height
- Rain glass

Nominal Dimensions:

60 in x 70 in (1524 mm x 1/4 in x 1778 mm)

Description	Net Wt	SKU	Color	List Price
Euro 70-Inch Height Semi-Frameless Sliding Shower Door	84 lb	AM00390422.006	Brushed Nickel	1,825
	38.1 kg			
	80 lb	AM00390422.213	Silver Shine	1,416
	36.3 kg			
	84 lb	AM00390422.224	Oil Rubbed Bronze	1,825
	38.1 kg			

Images are for illustrative purposes only - exact features may vary.



Prestige 58-1/2-Inch Height Framed Sliding Tub Door

- Framed sliding tub door
- Heavy duty rounded header
- Easy-to-clean bottom track system
- Simple out-of-square adjustment
- Two bracketed towel bars
- 3/16" (5 mm) safety tempered glass
- Minimum 1-1/2" (38 mm) threshold width required
- Fits opening: 57" – 59" (1448 – 1499 mm)
- 58-1/2" (1486 mm) height
- Clear glass

Nominal Dimensions:

60 in x 58-1/2 in (1524 mm x 1/4 in x 1485 mm)

Description	Net Wt	SKU	Color	List Price
Prestige 58-1/2-Inch Height Framed Sliding Tub Door	58 lb 26.3 kg	AM00750400.006	Brushed Nickel	951
		AM00750400.213	Silver Shine	717
		AM00750400.224	Oil Rubbed Bronze	951



Prestige 58-1/2-Inch Framed Sliding Tub Door

- Framed sliding tub door
- Heavy duty rounded header
- Easy-to-clean bottom track system
- Simple out-of-square adjustment
- Two bracketed towel bars
- 3/16" (5 mm) safety tempered glass
- Minimum 1-1/2" (38 mm) threshold width required
- Fits opening: 57" – 59" (1448 – 1499 mm)
- 58-1/2" (1486 mm) height
- Rain glass

Nominal Dimensions:

60 in x 58-1/2 in (1524 mm x 1/4 in x 1485 mm)

Description	Net Wt	SKU	Color	List Price
Prestige 58-1/2-Inch Framed Sliding Tub Door	58 lb 26.3 kg	AM00750422.006	Brushed Nickel	998
		AM00750422.213	Silver Shine	717
		AM00750422.224	Oil Rubbed Bronze	998



Prestige 58-1/2-Inch Height Framed Sliding Tub Door

- Framed sliding tub door
- Heavy duty rounded header
- Easy-to-clean bottom track system
- Simple out-of-square adjustment
- Two bracketed towel bars
- 3/16" (5 mm) safety tempered glass
- Minimum 1-1/2" (38 mm) threshold width required
- Fits opening: 57" – 59" (1448 – 1499 mm)
- 58-1/2" (1486 mm) height
- Hammered glass

Nominal Dimensions:

60 in x 58-1/2 in (1524 mm x 1/4 in x 1485 mm)

Description	Net Wt	SKU	Color	List Price
Prestige 58-1/2-Inch Height Framed Sliding Tub Door	58 lb 26.3 kg	AM00750436.006	Brushed Nickel	998
		AM00750436.213	Silver Shine	717
		AM00750436.224	Oil Rubbed Bronze	998

Images are for illustrative purposes only - exact features may vary.



Prestige 71-1/2-Inch Height Framed Sliding Shower Door

- Framed sliding shower door
- Heavy duty rounded header
- Easy-to-clean bottom track system
- Simple out-of-square adjustment
- Two bracketed towel bars
- 3/16" (5 mm) safety-tempered glass
- Minimum 1-1/2" (38 mm) threshold width required
- Fits Opening: 45" – 47" (1143 – 1194 mm)
- 71-1/2" (1816 mm) height
- Clear glass

Nominal Dimensions:

60 in x 71-1/2 in (1524 mm x 1/4 in x 1816 mm)

Description	Net Wt	SKU	Color	List Price
Prestige 71-1/2-Inch Height Framed Sliding Shower Door	54 lb 24.5 kg	AM00770400.006	Brushed Nickel	1,012
		AM00770400.213	Silver Shine	798
		AM00770400.224	Oil Rubbed Bronze	1,012



Prestige 71-1/2-Inch Height Framed Sliding Shower Door

- Framed sliding shower door
- Heavy duty rounded header
- Easy-to-clean bottom track system
- Simple out-of-square adjustment
- Two bracketed towel bars
- 3/16" (5 mm) safety-tempered glass
- Minimum 1-1/2" (38 mm) threshold width required
- Fits opening: 57" – 59" (1448 – 1499 mm)
- 71-1/2" (1816 mm) height
- Clear glass

Nominal Dimensions:

60 in x 71-1/2 in (1524 mm x 1/4 in x 1816 mm)

Description	Net Wt	SKU	Color	List Price
Prestige 71-1/2-Inch Height Framed Sliding Shower Door	66 lb 30.0 kg	AM00790400.006	Brushed Nickel	1,074
		AM00790400.213	Silver Shine	881
		AM00790400.224	Oil Rubbed Bronze	1,074

Shower and Tub Enclosures/Bathing Fixture – Cross Reference

Dimensions	Model	Description	Euro Semi-Frameless		Prestige Framed	
Tubs			Tub Doors		Tub Doors	
5'	2772	Cadet®	AM00350		AM00750	AM00758
	2461	Cambridge®				
	2425, 2422, 2771V	Evolution®				
	3571, 3574	Green Tea®				
	0255	New Salem®				
	0263	New Solar®				
	2391, 2390, 2393, 2392, 2395, 2394, 2397, 2396	Princeton®				
	2946, 2545, 2973	Studio®				
	2748	Town Square®				
	2544, 2545	Town Square S				
Solid Surface Shower Bases			Semi-Frameless Sliding	Semi-Frameless Swing with Panel	Semi-Frameless Top Roller	Framed Sliding
48" x 36" x 2" (1219 x 914 x 51 mm)	4836SMCOL	Townsend Single Threshold	AM00345 AM00370	AM00817	AM00821	AM00775 AM00770
60" x 30" x 2" (1524 x 762 x 51 mm)	6030SMRHOL 6030SMLHOL	Townsend Single Threshold	AM00390 AM00394	AM00816	AM00822	AM00790 AM00795
60" x 32" x 2" (1524 x 813 x 51 mm)	6032SMRHOL 6032SMLHOL	Townsend Single Threshold				
60" x 36" x 2" (1524 x 914 x 51 mm)	6036SMRHOL 6036SMLHOL	Townsend Single Threshold				
Acrylic Shower Bases			Semi-Frameless Sliding	Semi-Frameless Swing with Panel	Frameless Top Rolling	Framed Sliding
48" x 36" x 2-1/2" (1219 x 914 x 64 mm)	A8004L-CO	Studio Single Threshold	AM00345 AM00370	AM00817	AM00821	AM00775 AM00770
48-1/8" x 34-1/4" x 6-5/8" (1219 x 870 x 168 mm)	4834.ST	Single Threshold				
60" x 30" x 2-1/2" (1524 x 762 x 64 mm)	A8001L-RHO A8001L-LHO	Studio Single Threshold	AM00390 AM00394	AM00816	AM00822	AM00790 AM00795
60" x 31-1/4" x 5" (1524 x 794 x 127 mm)	2946.STR 2946.STL	Studio Single Threshold				
60" x 32" x 2-1/2" (1524 x 813 x 64 mm)	A8002L-RHO A8002L-LHO	Studio Single Threshold				
60" x 36" x 2-1/2" (1524 x 914 x 64 mm)	A8003L-RHO A8003L-LHO	Studio Single Threshold				
60-1/8" x 34-1/8" x 6-5/8" (1527 x 867 x 168 mm)	6034.ST	Single Threshold				

Please take the height of alcove walls into consideration when choosing doors. Doors are adjustable to fit installations both with and without alcove walls.



Studio® 38 x 38-Inch Single Threshold ADA Shower Base With Center Drain

- Clean, contemporary design
- High-quality acrylic with fiberglass reinforcement
- Easy-to-clean high-gloss surface that's UV stable and stain resistant
- Easy to step over 2-1/2" (64 mm) threshold height
- Integral 3-sided tile/water retention flange
- Single threshold, center drain
- Brushed stainless steel drain cover included
- Drain not included
- ADA compliant
- Limited lifetime warranty

Nominal Dimensions:

38 in x 38 in x .9 in (965 mm x 965 mm x 22 mm)



Description	Net Wt	SKU	Color	List Price
Studio® 38 x 38-Inch Single Threshold ADA Shower Base With Center Drain	24 lb 11.3 kg	A8009D-FCO.020	White	775

Separate Components:

Stainless Steel Drain Plate	2 lb 0.9 kg	▷755453-400.0730A	Brushed Stainless Steel	171
-----------------------------	----------------	-------------------	-------------------------	-----

Studio® 48 x 36-Inch Single Threshold Shower Base With Center Drain



- Clean, contemporary design
- High-quality acrylic with fiberglass reinforcement
- Easy to clean high-gloss surface that's UV stable and stain resistant
- Easy to step over 2-1/2" (64 mm) threshold height
- Integral 3-sided tile/water retention flange
- Single threshold, center drain
- Brushed stainless steel drain cover included
- Drain not included
- Limited lifetime warranty

Nominal Dimensions:

48 in x 36 in x 3-1/2 in (1219 mm x 914 mm x 88 mm)



Description	Net Wt	SKU	Color	List Price
Studio® 48 x 36-Inch Single Threshold Shower Base With Center Drain	39 lb 18.1 kg	A8004L-CO.020	White	770

Optional Components:

Stainless Steel Drain Plate	2 lb 0.9 kg	▷755453-400.0730A	Brushed Stainless Steel	171
-----------------------------	----------------	-------------------	-------------------------	-----

Studio® 60 x 30-Inch Single Threshold Shower Base With Right-Hand Outlet



- Clean, contemporary design
- High-quality acrylic with fiberglass reinforcement
- Easy-to-clean high-gloss surface that's UV stable and stain resistant
- Easy to step over 2-1/2" (64 mm) threshold height
- Integral 3-sided tile/water retention flange
- Single threshold, right-hand outlet
- Brushed stainless steel drain cover included
- Drain not included
- Limited lifetime warranty

Nominal Dimensions:

60 in x 30 in x 3-1/2 in (1524 mm x 762 mm x 88 mm)



Description	Net Wt	SKU	Color	List Price
Studio® 60 x 30-Inch Single Threshold Shower Base With Right-Hand Outlet	41 lb 18.8 kg	A8001L-RHO.020	White	799

Optional Components:

Stainless Steel Drain Plate	2 lb 0.9 kg	▷755453-400.0730A	Brushed Stainless Steel	171
-----------------------------	----------------	-------------------	-------------------------	-----

Studio® 60 x 30-Inch Single Threshold Shower Base With Left-Hand Outlet



- Clean, contemporary design
- High-quality acrylic with fiberglass reinforcement
- Easy-to-clean high-gloss surface that's UV stable and stain resistant
- Easy to step over 2-1/2" (64 mm) threshold height
- Integral 3-sided tile/water retention flange
- Single threshold, left-hand outlet
- Brushed stainless steel drain cover included
- Drain not included
- Limited lifetime warranty

Nominal Dimensions:

60 in x 30 in x 3-1/2 in (1524 mm x 762 mm x 88 mm)



Description	Net Wt	SKU	Color	List Price
Studio® 60 x 30-Inch Single Threshold Shower Base With Left-Hand Outlet	41 lb 18.8 kg	A8001L-LHO.020	White	799

Separate Components:

Stainless Steel Drain Plate	2 lb 0.9 kg	▷755453-400.0730A	Brushed Stainless Steel	171
-----------------------------	----------------	-------------------	-------------------------	-----

▷ Parts Program (Non-Premier)



Studio® 60 x 32-Inch Single Threshold Shower Base With Right-Hand Outlet

- Clean, contemporary design
- High-quality acrylic with fiberglass reinforcement
- Easy-to-clean high-gloss surface that's UV stable and stain resistant
- Easy to step over 2-1/2" (64 mm) threshold height
- Integral 3-sided tile/water retention flange
- Single threshold, right-hand outlet
- Brushed stainless steel drain cover included
- Drain not included
- Limited lifetime warranty

Nominal Dimensions:

60 in x 32 in x 3-1/2 in (1524 mm x 812 mm x 88 mm)



Description	Net Wt	SKU	Color	List Price
Studio® 60 x 32-Inch Single Threshold Shower Base With Right-Hand Outlet	49 lb 22.7 kg	A8002L-RHO.020	White	810

Optional Components:

Stainless Steel Drain Plate	2 lb 0.9 kg	▷755453-400.0730A	Brushed Stainless Steel	171
-----------------------------	----------------	-------------------	-------------------------	-----



Studio® 60 x 32-Inch Single Threshold Shower Base With Left-Hand Outlet

- Clean, contemporary design
- High-quality acrylic with fiberglass reinforcement
- Easy-to-clean high-gloss surface that's UV stable and stain resistant
- Easy to step over 2-1/2" (64 mm) threshold height
- Integral 3-sided tile/water retention flange
- Single threshold, left-hand outlet
- Brushed stainless steel drain cover included
- Drain not included
- Limited lifetime warranty

Nominal Dimensions:

60 in x 32 in x 3-1/2 in (1524 mm x 812 mm x 88 mm)



Description	Net Wt	SKU	Color	List Price
Studio® 60 x 32-Inch Single Threshold Shower Base With Left-Hand Outlet	49 lb 22.7 kg	A8002L-LHO.020	White	810

Separate Components:

Stainless Steel Drain Plate	2 lb 0.9 kg	▷755453-400.0730A	Brushed Stainless Steel	171
-----------------------------	----------------	-------------------	-------------------------	-----



Studio® 60 x 36-Inch Single Threshold Shower Base With Right-Hand Outlet

- Clean, contemporary design
- High-quality acrylic with fiberglass reinforcement
- Easy-to-clean high-gloss surface that's UV stable and stain resistant
- Easy to step over 2-1/2" (64 mm) threshold height
- Integral 3-sided tile/water retention flange
- Single threshold, right-hand outlet
- Brushed stainless steel drain cover included
- Drain not included
- Limited lifetime warranty

Nominal Dimensions:

60 in x 36 in x 4 in (1524 mm x 914 mm x 101 mm)



Description	Net Wt	SKU	Color	List Price
Studio® 60 x 36-Inch Single Threshold Shower Base With Right-Hand Outlet	55 lb 25.3 kg	A8003L-RHO.020	White	887

Optional Components:

Stainless Steel Drain Plate	2 lb 0.9 kg	▷755453-400.0730A	Brushed Stainless Steel	171
-----------------------------	----------------	-------------------	-------------------------	-----

▷ Parts Program (Non-Premier)

Studio® 60 x 36-Inch Single Threshold Shower Base With Left-Hand Outlet



- Clean, contemporary design
- High-quality acrylic with fiberglass reinforcement
- Easy-to-clean high-gloss surface that's UV stable and stain resistant
- Easy to step over 2-1/2" (64 mm) threshold height
- Integral 3-sided tile/water retention flange
- Single threshold, left-hand outlet
- Brushed stainless steel drain cover included
- Drain not included
- Limited lifetime warranty

Nominal Dimensions:

60 in x 36 in x 4 in (1524 mm x 914 mm x 101 mm)



Description	Net Wt	SKU	Color	List Price
Studio® 60 x 36-Inch Single Threshold Shower Base With Left-Hand Outlet	55 lb 25.3 kg	A8003L-LHO.020	White	887

Separate Components:

Stainless Steel Drain Plate	2 lb 0.9 kg	▷755453-400.0730A	Brushed Stainless Steel	171
-----------------------------	----------------	-------------------	-------------------------	-----

Studio® 64 x 34-Inch Single Threshold ADA Shower Base With Center Drain



- Clean, contemporary design
- High-quality acrylic with fiberglass reinforcement
- Easy-to-clean high-gloss surface that's UV stable and stain resistant
- Easy to step over 2-1/2" (64 mm) threshold height
- Integral 3-sided tile/water retention flange
- Single threshold, center drain
- Brushed stainless steel drain cover included
- Drain not included
- ADA compliant
- Limited lifetime warranty

Nominal Dimensions:

64 in x 34 in x .9 in (1625 mm x 863 mm x 22 mm)



Description	Net Wt	SKU	Color	List Price
Studio® 64 x 34-Inch Single Threshold ADA Shower Base With Center Drain	36 lb 16.3 kg	A8007D-FCO.020	White	917

Separate Components:

Stainless Steel Drain Plate	2 lb 0.9 kg	▷755453-400.0730A	Brushed Stainless Steel	171
-----------------------------	----------------	-------------------	-------------------------	-----

Studio® 60 x 32 x 72-Inch Shower Wall Set



- Includes two side walls and one back wall
- Six integrated extra deep 4-1/2" (114 mm) shelves
- High-impact polystyrene
- Mounts directly to studs – no backer board needed
- Tongue and groove interlocking for alignment and to prevent water seepage
- Limited lifetime warranty
- For use with 011 Arctic White 60" x 32" (1524 x 813 mm) bathtub models

Nominal Dimensions:

60 in x 32 in x 72 in (1524 mm x 812 mm x 1828 mm)



Description	Net Wt	SKU	Color	List Price
Studio® 60 x 32 x 72-Inch Shower Wall Set	31 lb 14.1 kg	2946SW.011	Arctic	1,111

▷ Parts Program (Non-Premier)



Townsend® 38 x 38-Inch Single Threshold ADA Shower Base With Center Drain

- Clean, contemporary design
- Durable 100% solid, non-porous material that's fungi and bacterial resistant
- Smooth matte renewable surface where chips and scratched can be sanded out
- Easy maintenance and cleaning, stain and UV resistant
- Integral 3-sided tile/water retention flange
- Single threshold, center drain
- Removable, stainless steel trench drain cover included
- Drain not included
- Self-extinguishing – tested against ASTM E84
- ADA compliant
- 5-year warranty
- Project volume greater than 60 pieces needs additional lead time

Nominal Dimensions:

38 in x 38 in x 4-5/16 in (965 mm x 965 mm x 109 mm)



Description	Net Wt	SKU	Color	List Price
Townsend® 38 x 38-Inch Single Threshold ADA Shower Base With Center Drain	84 lb 38.5 kg	3838AM-FCOL.218	Soft White	1,104

Optional Components:

38" x 38" Stainless Steel Drain Cover	4 lb 1.9 kg	▷755446-400.0730A	Brushed Stainless Steel	167
---------------------------------------	----------------	-------------------	-------------------------	-----



Townsend® 48 x 36-Inch Single Threshold Shower Bases With Center Drain

- Clean, contemporary design
- Durable 100% solid, non-porous material that's fungi and bacterial resistant
- Smooth matte renewable surface where chips and scratched can be sanded out
- Easy maintenance and cleaning, stain and UV resistant
- Integral 3-sided tile/water retention flange
- Single threshold, center drain
- Removable, color-matched, solid surface square drain cover included
- Drain not included
- Self-extinguishing – tested against ASTM E84
- 5-year warranty
- Project volume greater than 60 pieces needs additional lead time

Nominal Dimensions:

38 in x 38 in x 3-7/8 in (965 mm x 965 mm x 98 mm)



Description	Net Wt	SKU	Color	List Price
Townsend® 48 x 36-Inch Single Threshold Shower Bases With Center Drain	96 lb 43.9 kg	4836SM-COL.218	Soft White	1,052

Optional Components:

48" x 36" Square Solid Surface Drain Cover	0 lb 0.4 kg	▷755433-401.2180A	Soft White	109
--	----------------	-------------------	------------	-----



Townsend® 60 x 30-Inch Single Threshold Shower Base With Right-Hand Outlet

- Clean, contemporary design
- Durable 100% solid, non-porous material that's fungi and bacterial resistant
- Smooth matte renewable surface where chips and scratched can be sanded out
- Easy maintenance and cleaning, stain and UV resistant
- Integral 3-sided tile/water retention flange
- Single threshold, right-hand outlet
- Removable, color-matched, solid surface trench drain cover included
- Drain not included
- Self-extinguishing – tested against ASTM E84
- 5-year warranty
- Project volume greater than 60 pieces needs additional lead time

Nominal Dimensions:

60 in x 30 in x 3-5/16 in (1524 mm x 762 mm x 84 mm)



Description	Net Wt	SKU	Color	List Price
Townsend® 60 x 30-Inch Single Threshold Shower Base With Right-Hand Outlet	100 lb 45.5 kg	6030SM-RHOL.218	Soft White	1,098

Optional Components:

60" x 30" Rectangle Solid Surface Drain Cover	4 lb 2.1 kg	▷755427-401.2180A	Soft White	251
---	----------------	-------------------	------------	-----

▷ Parts Program
(Non-Premier)



Townsend® 60 x 30-Inch Single Threshold Shower Base With Left-Hand Outlet

- Clean, contemporary design
- Durable 100% solid, non-porous material that's fungi and bacterial resistant
- Smooth matte renewable surface where chips and scratches can be sanded out
- Easy maintenance and cleaning, stain and UV resistant
- Integral 3-sided tile/water retention flange
- Single threshold, left-hand outlet
- Removable, color-matched, solid surface trench drain cover included
- Drain not included
- Self-extinguishing – tested against ASTM E84
- 5-year warranty
- Project volume greater than 60 pieces needs additional lead time

Nominal Dimensions:

60 in x 30 in x 3-5/16 in (1524 mm x 762 mm x 84 mm)



Description	Net Wt	SKU	Color	List Price
Townsend® 60 x 30-Inch Single Threshold Shower Base With Left-Hand Outlet	100 lb 45.5 kg	6030SM-LHOL.218	Soft White	1,098

Separate Components:

60" x 30" Rectangle Solid Surface Drain Cover	4 lb 2.1 kg	▷755427-401.2180A	Soft White	251
---	----------------	-------------------	------------	-----



Townsend® 60 x 32-Inch Single Threshold Shower Base With Right-Hand Outlet

- Clean, contemporary design
- Durable 100% solid, non-porous material that's fungi and bacterial resistant
- Smooth matte renewable surface where chips and scratches can be sanded out
- Easy maintenance and cleaning, stain and UV resistant
- Integral 3-sided tile/water retention flange
- Single threshold, right-hand outlet
- Removable, color-matched, solid surface trench drain cover included
- Drain not included
- Self-extinguishing – tested against ASTM E84
- 5-year warranty
- Project volume greater than 60 pieces needs additional lead time

Nominal Dimensions:

60 in x 32 in x 3-5/16 in (1524 mm x 812 mm x 84 mm)



Description	Net Wt	SKU	Color	List Price
Townsend® 60 x 32-Inch Single Threshold Shower Base With Right-Hand Outlet	106 lb 48.3 kg	6032SM-RHOL.218	Soft White	1,110

Optional Components:

60" x 32" Rectangle Solid Surface Drain Cover	4 lb 2.2 kg	▷755429-401.2180A	Soft White	251
---	----------------	-------------------	------------	-----



Townsend® 60 x 32-Inch Single Threshold Shower Base With Left-Hand Outlet

- Clean, contemporary design
- Durable 100% solid, non-porous material that's fungi and bacterial resistant
- Smooth matte renewable surface where chips and scratches can be sanded out
- Easy maintenance and cleaning, stain and UV resistant
- Integral 3-sided tile/water retention flange
- Single threshold, left-hand outlet
- Removable, color-matched, solid surface trench drain cover included
- Drain not included
- Self-extinguishing – tested against ASTM E84
- 5-year warranty
- Project volume greater than 60 pieces needs additional lead time

Nominal Dimensions:

60 in x 32 in x 3-5/16 in (1524 mm x 812 mm x 84 mm)



Description	Net Wt	SKU	Color	List Price
Townsend® 60 x 32-Inch Single Threshold Shower Base With Left-Hand Outlet	106 lb 48.3 kg	6032SM-LHOL.218	Soft White	1,110

Separate Components:

60" x 32" Rectangle Solid Surface Drain Cover	4 lb 2.2 kg	▷755429-401.2180A	Soft White	251
---	----------------	-------------------	------------	-----

▷ Parts Program
(Non-Premier)



Townsend® 60 x 36-Inch Single Threshold Shower Base With Right-Hand Outlet

- Clean, contemporary design
- Durable 100% solid, non-porous material that's fungi and bacterial resistant
- Smooth matte renewable surface where chips and scratches can be sanded out
- Easy maintenance and cleaning, stain and UV resistant
- Integral 3-sided tile/water retention flange
- Single threshold, right-hand outlet
- Removable, color-matched, solid surface trench drain cover included
- Drain not included
- Self-extinguishing – tested against ASTM E84
- 5-year warranty
- Project volume greater than 60 pieces needs additional lead time

Nominal Dimensions:

60 in x 36 in x 3-5/16 in (1524 mm x 914 mm x 84 mm)



Description	Net Wt	SKU	Color	List Price
Townsend® 60 x 36-Inch Single Threshold Shower Base With Right-Hand Outlet	118 lb 53.6 kg	6036SM-RHOL.218	Soft White	1,233

Optional Components:

60" x 36" Rectangle Solid Surface Drain Cover	5 lb 2.5 kg	▷755431-401.2180A	Soft White	259
---	----------------	-------------------	------------	-----



Townsend® 60 x 36-Inch Single Threshold Shower Base With Left-Hand Outlet

- Clean, contemporary design
- Durable 100% solid, non-porous material that's fungi and bacterial resistant
- Smooth matte renewable surface where chips and scratches can be sanded out
- Easy maintenance and cleaning, stain and UV resistant
- Integral 3-sided tile/water retention flange
- Single threshold, left-hand outlet
- Removable, color-matched, solid surface trench drain cover included
- Drain not included
- Self-extinguishing – tested against ASTM E84
- 5-year warranty
- Project volume greater than 60 pieces needs additional lead time

Nominal Dimensions:

60 in x 36 in x 3-5/16 in (1524 mm x 914 mm x 84 mm)



Description	Net Wt	SKU	Color	List Price
Townsend® 60 x 36-Inch Single Threshold Shower Base With Left-Hand Outlet	118 lb 53.6 kg	6036SM-LHOL.218	Soft White	1,233

Separate Components:

60" x 36" Rectangle Solid Surface Drain Cover	5 lb 2.5 kg	▷755431-401.2180A	Soft White	259
---	----------------	-------------------	------------	-----



Townsend® 64 x 34-Inch Single Threshold ADA Shower Base With Linear Drain

- Clean, contemporary design
- Durable 100% solid, non-porous material that's fungi and bacterial resistant
- Smooth matte renewable surface where chips and scratches can be sanded out
- Easy maintenance and cleaning, stain and UV resistant
- Integral 3-sided tile/water retention flange
- Single threshold, linear drain along entry
- Removable, stainless steel trench drain cover included
- Drain not included
- Self-extinguishing – tested against ASTM E84
- ADA compliant
- 5-year warranty

Nominal Dimensions:

64 in x 34 in x 1-3/8 in (1625 mm x 863 mm x 34 mm)



Description	Net Wt	SKU	Color	List Price
Townsend® 64 x 34-Inch Single Threshold ADA Shower Base With Linear Drain	124 lb 56.6 kg	6434AM-FCOL.218	Soft White	1,452

Optional Components:

64" x 34" Stainless Steel Drain Cover	7 lb 3.4 kg	▷755440-400.0730A	Brushed Stainless Steel	167
---------------------------------------	----------------	-------------------	-------------------------	-----

▷ Parts Program
(Non-Premier)

Bathroom Furniture

Crafted with care to complement today's most beautiful bathrooms, the **American Standard Collection** ensures lasting durability and design excellence. Whether open for a spacious look or enclosed for concealed storage, you'll find the perfect piece on the following pages.



Bathroom Furniture

Furniture Overview

Masterfully constructed from poplar solids and birch veneers.
Furniture specifically designed for coordinating sinks and countertops.

Edgemere® Console	Retrospect® Console	Town Square® S Collection	
			

Studio® S Collection		
		

American Standard® Furniture for Townsend® Collection		
		

All American Standard furniture is fully CARB compliant.



Edgemere® Console Table

- Transitional style metal console table
- Uses Edgemere® 0445 series pedestal tops
- Console table legs feature transitional styling with integral front and side towel bars
- Lower tempered glass shelf for storage
- Legs available in Polished Chrome or Brushed Nickel
- Dimensions with 0445 Series Pedestal Tops: 25" x 19-1/2" x 35-11/16" (635 x 495 x 906 mm)

Nominal Dimensions:

25 in x 19-1/2 in x 35-11/16 in (635 mm x 495 mm x 906 mm)



Description	Net Wt	SKU	Color	List Price
Edgemere® Console Table	17 lb	8719000.002	Polished Chrome	568
	7.8 kg	8719000.295	Brushed Nickel	682

Separate Components:

Console Mounting Kit	0 lb 0.2 kg	▷770248-100.0070A	No Finish	7
Console Feet		▷770256-200.0020A	Polished Chrome	19
		▷770256-200.2950A	Brushed Nickel	23

Required Components:

Edgemere® Center Hole Only Pedestal Sink Top	40 lb 18.5 kg	0445001.020	White	204
Edgemere® 4-Inch Centerset Pedestal Sink Top		0445004.020	White	204
Edgemere® 8-Inch. Widespread Pedestal Sink Top		0445008.020	White	204



Retrospect® Console Table

- Classic style metal console table
- Uses Retrospect® 0282 series pedestal tops
- Console table legs feature classic styling with integral front and side towel bars
- Lower tempered glass shelf for storage
- Legs available in Polished Chrome
- Dimensions with 0282 Series Pedestal Tops: 27" x 19-3/4" x 36" (686 x 502 x 914 mm)

Nominal Dimensions:

27 in x 19-3/4 in x 36 in (686 mm x 501 mm x 914 mm)



Description	Net Wt	SKU	Color	List Price
Retrospect® Console Table	28 lb 12.7 kg	8711000.002	Polished Chrome	881

Required Components:

Retrospect® 8-Inch Widespread Pedestal Sink Top	37 lb 17.1 kg	0282008.020	White	382
---	------------------	-------------	-------	-----



Town Square® S Console Table

- Classic style metal console table
- Requires Town Square® S 0297 series pedestal tops (ordered separately)
- Console table legs feature traditional styling with integral front and slide towel bars
- Legs available in Polished Chrome or Brushed Nickel
- Dimensions with 0297 Series Pedestal Tops: 30" x 22-1/2" x 35" (762 x 571 x 889 mm)

Nominal Dimensions:

30 in x 22-1/2 in x 35 in (762 mm x 571 mm x 889 mm)



Description	Net Wt	SKU	Color	List Price
Town Square® S Console Table	15 lb	8721000.002	Polished Chrome	961
	7.1 kg	8721000.295	Brushed Nickel	1,153

Separate Components:

Leveling Feet	0 lb 0.0 kg	▷770258-200.0070A	No Finish	14
Hardware Kit For Townsend Metal Console		▷770262-100.0070A	No Finish	14

Required Components:

Town Square® S Center Hole Only Pedestal Sink Top	41 lb 18.6 kg	0297001.020	White	365
Town Square® S 4-Inch Centerset Pedestal Sink Top		0297004.020	White	357
Town Square® S 8-Inch Widespread Pedestal Sink Top		0297008.020	White	365
Decorative P-Trap	2 lb 1.1 kg	7720018.002	Polished Chrome	133
		7720018.295	Brushed Nickel	186



Town Square® S Washstand

- Traditional style washstand with glass storage shelf
- Requires 0298 based vanity sink and 3829 based towel bar (ordered separately)
- Coordinates with the Town Square® S collection
- Above Counter Vanity Sink and Furniture Combination Dimensions: 31" x 22-1/2" x 35" (787 x 571 x 889 mm)



Description	Net Wt	SKU	Color	List Price
Town Square® S Washstand	18 lb	9056030.020	White	763
	8.2 kg	9056030.476	Dark Cherry	763

Separate Components:

Towel Bar Mounting Kit	0 lb 0.0 kg	▷770259-100.0070A	No Finish	14
------------------------	----------------	-------------------	-----------	----

Required Components:

Town Square® S Console Vanity Sink Top Center Hole Only	26 lb 11.8 kg	0298001.020	White	393
Town Square® S Vanity Top with 8-Inch Widespread		0298008.020	White	393
Town Square® S Washstand Towel Bar	0 lb 0.4 kg	3829000.002	Polished Chrome	109
		3829000.295	Brushed Nickel	165



Town Square® S Washstand Towel Bar

- Required for 9056030 Town Square® S Washstand
- Bar available in Polished Chrome or Brushed Nickel



Description	Net Wt	SKU	Color	List Price
Town Square® S Washstand Towel Bar	0 lb 0.4 kg	3829000.002	Polished Chrome	109
		3829000.295	Brushed Nickel	165

Separate Components:

Towel Bar Mounting Kit	0 lb 0.0 kg	▷770259-100.0070A	No Finish	14
------------------------	----------------	-------------------	-----------	----



Washstand for American Standard® Townsend® Sinks

- Design matched washstand coordinates with Townsend® suite of fixtures and fittings
- Choose one of two Townsend® sink top types for vanity (ordered separately): 0328 series pedestal top or 0330000 under counter sink
- Requires towel bar (ordered separately)
- Under counter sink requires quartz top too (ordered separately)
- Dimensions with 0328 Series Pedestal Tops: 30" x 19-1/2" x 35-7/8" (762 x 495 x 910mm)
- Dimensions with 0330 Under Counter Sink and Quartz Top: 30" x 20" x 34" (762 x 508 x 863 mm)

Nominal Dimensions:

713 mm x 462 mm x 833 mm (713 mm x 462 mm x 833 mm)



Description	Net Wt	SKU	Color	List Price
Washstand for American Standard® Townsend® Sinks	16 lb	9039030.020	White	779
	7.4 kg	9039030.475	Smoked Grey	779

Separate Components:

Towel Bar Mounting Kit	0 lb 0.0 kg	▶770252-100.0070A	No Finish	7
------------------------	----------------	-------------------	-----------	---

Required Components:

Townsend® Center Hole Only Pedestal Sink Top	53 lb 24.1 kg	0328001.020	White	357
Townsend® 8-Inch Widespread Pedestal Sink Top		0328008.020	White	357
Townsend® Under Counter Sink	17 lb 7.7 kg	0330000.020	White	258
Towel Bar for American Standard® Townsend® Washstand	0 lb 0.4 kg	3749000.002	Polished Chrome	111
		3749000.243	Matte Black	168
		3749000.295	Brushed Nickel	168
Quartz Top with 8-Inch Widespread for Townsend® Under Counter Sink	37 lb 17.2 kg	7840800.820	Quartz	624



Studio® S 24-Inch Vanity

- Contemporary styled vanity with two drawers and drawer divided inserts
- Requires 1297 based vanity sink top (ordered separately)
- Vanity can be installed with optional vanity leg set or mounted directly to wall
- Double vanity installation available by using optional vanity middle
- Coordinates with the Studio® S collection of bathroom faucets and accessories
- Single Vanity Option: 24" x 20" x 34-1/16" (603 x 508 x 866 mm)
- Double Vanity with Vanity Middle Option: 58" x 20" x 34-1/16" (1424 x 508 x 866 mm)

Nominal Dimensions:

24" x 20" x 34-1/16" (603 x 508 x 866 mm)



Description	Net Wt	SKU	Color	List Price
Studio® S 24-Inch Vanity	55 lb	8725024.020	White	1,298
	25.2 kg	8725024.477	Dark Grey	1,298

Required Components:

Studio® S 24-Inch Vitreous China Vanity Sink Top Center Hole Only	26 lb 11.8 kg	1297001.020	White	408
Studio® S 24-Inch Vitreous China Vanity Sink Top 8-Inch Centers		1297008.020	White	408

Optional Components:

Studio® S Vanity Leg Set	7 lb	8722000.002	Polished Chrome	666
	3.5 kg	8722000.243	Matte Black	738
Studio® S Vanity Middle	31 lb	8727000.020	White	625
	14.1 kg	8727000.477	Dark Grey	625



Studio® S 33-Inch Vanity

- Contemporary styled vanity with two drawers and drawer divided inserts
- Requires 1298 based vanity sink top or 1296000 sink with 7813001 top (ordered separately)
- Vanity can be installed with optional vanity leg set or mounted directly to wall
- Double vanity installation available by using optional vanity middle
- Coordinates with the Studio® S collection of bathroom faucets and accessories
- Single Vanity Option: 33" x 20" x 34-1/16" (838 x 508 x 866 mm)
- Double Vanity with Vanity Middle Option: 76" x 20" x 34-1/16" (1930 x 508 x 866 mm)

Nominal Dimensions:

33" x 20" x 34-1/16" (838 x 508 x 866 mm)



Description	Net Wt	SKU	Color	List Price
Studio® S 33-Inch Vanity	67 lb	8726033.020	White	1,416
	30.4 kg	8726033.477	Dark Grey	1,416

Required Components:

Studio® S Above Counter Oval Sink	17 lb 7.9 kg	1296000.020	White	370
Studio® S 33-Inch Vitreous China Vanity Sink Top Center Hole Only	35 lb	1298001.020	White	437
	16.2 kg	1298008.020	White	437
Studio® S 33-Inch Vitreous China Vanity Sink Top 8-Inch Centers		1298008.020	White	437
Studio® S Above Counter Sink Top with Center Hole Only	11 lb	7813001.478	Ash	536
	5.3 kg	7813001.479	Walnut	536

Optional Components:

Studio® S Vanity Leg Set	7 lb	8722000.002	Polished Chrome	666
	3.5 kg	8722000.243	Matte Black	738
Studio® S Vanity Middle	31 lb	8727000.020	White	625
	14.1 kg	8727000.477	Dark Grey	625

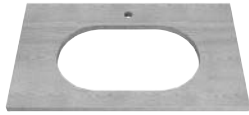

Studio® S Above Counter Sink Top with Center Hole Only

- Contemporary style top is designed to go on 33-inch Studio S vanity
- Requires 8726033 vanity and 1296000 sink (ordered separately)
- Vanity can be installed with optional vanity leg set or mounted directly to wall
- Double vanity installation available by using optional vanity middle
- Coordinates with the Studio® S collection of bathroom faucets and accessories
- Top is for center hole only faucet (sold separately)

Nominal Dimensions:

33 in x 20 in (838 mm x 508 mm)



Description	Net Wt	SKU	Color	List Price
Studio® S Above Counter Sink Top with Center Hole Only	11 lb	7813001.478	Ash	536
	5.3 kg	7813001.479	Walnut	536



Studio® S Vanity Leg Set

- Contemporary styled metal legs are for the 24-inch and 33-inch Studio S Vanities
- Requires 8725024 or 8726033 based Studio S vanity (ordered separately)
- Vanity can be installed with optional vanity leg set or mounted directly to wall
- Double vanity installation available by using optional vanity middle
- Coordinates with the Studio® S collection of bathroom faucets and accessories
- Legs are weight bearing
- Legs available in Polished Chrome or Matte Black

Nominal Dimensions:

465 mm x 0 in x 334 mm (465 mm x 0 mm x 334 mm)



Description	Net Wt	SKU	Color	List Price
Studio® S Vanity Leg Set	7 lb	8722000.002	Polished Chrome	666
	3.5 kg	8722000.243	Matte Black	738



Studio® S Vanity Middle

- Contemporary styled vanity middle is installed between two Studio S vanities for double sink installations
- Requires 8725024 or 8726033 based Studio S vanities (ordered separately)
- Vanity can be installed with optional vanity leg set or mounted directly to wall
- Coordinates with the Studio® S collection of bathroom faucets and accessories

Nominal Dimensions:

255 mm x 488 mm x 500 mm (255 mm x 488 mm x 500 mm)



Description	Net Wt	SKU	Color	List Price
Studio® S Vanity Middle	31 lb	8727000.020	White	625
	14.1 kg	8727000.477	Dark Grey	625



Vanity for American Standard® Townsend® Sinks

- 30-inch vanity coordinates with design matched vanity Townsend® suite fixtures and fittings
- Choose one of three Townsend® sink top types for vanity (ordered separately): 0328 series pedestal top, 0329 series above counter sink, or 0330000 under counter sink
- Requires two drawer pulls (ordered separately)
- Above counter and under counter sinks require quartz tops too (ordered separately)
- Dimensions with 0328 Series Pedestal Tops: 30" x 19-1/2" x 35-7/8" (762 x 495 x 910mm)
- Dimensions with 0330 Under Counter Sink and Quartz Top: 30" x 20" x 34" (762 x 508 x 863 mm)



Description	Net Wt	SKU	Color	List Price
Vanity for American Standard® Townsend® Sinks	66 lb 30.0 kg	9036030.020	White	1,192
		9036030.475	Smoked Grey	1,192

Separate Components:

Drawer Pull Mounting Kit	0 lb 0.0 kg	▶770251-100.0070A	No Finish	7
--------------------------	----------------	-------------------	-----------	---

Required Components:

Townsend® Center Hole Only Pedestal Sink Top	53 lb 24.1 kg	0328001.020	White	357
Townsend® 8-Inch Widespread Pedestal Sink Top		0328008.020	White	357
Townsend® Under Counter Sink	17 lb 7.7 kg	0330000.020	White	258
Drawer Pulls Set for American Standard® Townsend® Vanity	1 lb 0.8 kg	7760000.002	Polished Chrome	111
		7760000.243	Matte Black	168
		7760000.295	Brushed Nickel	168
Quartz Top with 8-Inch Widespread for Townsend® Under Counter Sink	37 lb 17.2 kg	7840800.820	Quartz	624



Quartz Top with 8-Inch Widespread for Townsend® Under Counter Sink

- Transitional style top is designed to go on 30-inch Townsend vanity or washstand
- Requires 9036030 vanity or 9039030 washstand and 0330000 under counter sink (ordered separately)
- Faucet holes on 8-inch (203 mm) centers
- Top is for widespread faucet (sold separately)

Nominal Dimensions:

30 in x 20 in (762 mm x 508 mm)



Description	Net Wt	SKU	Color	List Price
Quartz Top with 8-Inch Widespread for Townsend® Under Counter Sink	37 lb 17.2 kg	7840800.820	Quartz	624



Towel Bar for American Standard® Townsend® Washstand

- Required for 9039030 American Standard® Washstand for Townsend® sinks
- Available in Polished Chrome or Brushed Nickel



Description	Net Wt	SKU	Color	List Price
Towel Bar for American Standard® Townsend® Washstand	0 lb 0.4 kg	3749000.002	Polished Chrome	111
		3749000.243	Matte Black	168
		3749000.295	Brushed Nickel	168



Drawer Pulls Set for American Standard® Townsend® Vanity

- Set of two required for 9036030 American Standard® Townsend® Vanity
- Drawer pull set available in Polished Chrome or Brushed Nickel

Nominal Dimensions:

299 mm x 29 mm x 12.7 mm (299 mm x 29 mm x 12 mm)



Description	Net Wt	SKU	Color	List Price
Drawer Pulls Set for American Standard® Townsend® Vanity	1 lb 0.8 kg	7760000.002	Polished Chrome	111
		7760000.243	Matte Black	168
		7760000.295	Brushed Nickel	168

Bathroom Sinks

Choosing the perfect bathroom sink requires attention to detail. Is it practical and appealing? Does it fit the space? Will it be a focal point? The American Standard collection includes a style to satisfy every situation and design aesthetic.



Bathroom Sinks

Bathroom Sinks Overview

Pedestal



Above Counter



Drop-In



Under Counter



Wall-Hung





Boulevard® 4-Inch Centerset Pedestal Sink Top and Leg Combination

- Classic-styled rectangular pedestal sink
- Rear overflow
- Supplied with mounting kit
- Right height for greater comfort during use
- Design coordinates with Boulevard® toilet
- Basin has flat bottom to also allow use as an above counter sink or a drop-in sink (with U-shaped cutout)
- Fine fireclay construction

Nominal Dimensions:

24 in x 19 in x 35-1/2 in (609 mm x 482 mm x 901 mm)

Bowl Size:

17 in (wide) 12-1/2 in (front to back) 5 in (deep)



Description	Net Wt	SKU	Color	List Price
Boulevard® 4-Inch Centerset Pedestal Sink Top and Leg Combination		0641400.020	White	396

Separate Components:

Boulevard® and Tropic® Petite Pedestal Leg	24 lb 10.9 kg	0010000.020	White	151
Boulevard® 4-Inch Centerset Pedestal Sink Top	48 lb 22.0 kg	0641004.020	White	245



Boulevard® 8-Inch Widespread Pedestal Sink Top and Leg Combination

- Classic-styled rectangular pedestal sink
- Rear overflow
- Supplied with mounting kit
- Right height for greater comfort during use
- Design coordinates with Boulevard® toilet
- Basin has flat bottom to also allow use as an above counter sink or a drop-in sink (with U-shaped cutout)
- Fine fireclay construction

Nominal Dimensions:

24 in x 19 in x 35-1/2 in (609 mm x 482 mm x 901 mm)

Bowl Size:

17 in (wide) 12-1/2 in (front to back) 5 in (deep)



Description	Net Wt	SKU	Color	List Price
Boulevard® 8-Inch Widespread Pedestal Sink Top and Leg Combination		0641800.020	White	396

Separate Components:

Boulevard® and Tropic® Petite Pedestal Leg	24 lb 10.9 kg	0010000.020	White	151
Boulevard® 8-Inch Widespread Pedestal Sink Top	48 lb 22.0 kg	0641008.020	White	245



Boulevard® Center Hole Only Pedestal Sink Top and Leg Combination

- Classically styled rectangular pedestal sink
- Rear overflow
- Supplied with mounting kit
- Right height for greater comfort during use
- Design coordinates with Boulevard® toilet
- Basin has flat bottom to also allow use as an above counter sink or a drop-in sink (with U-shaped cutout)
- Fine fireclay construction

Nominal Dimensions:

24 in x 19 in x 35-1/2 in (609 mm x 482 mm x 901 mm)

Bowl Size:

17 in (wide) 12-1/2 in (front to back) 5 in (deep)



Description	Net Wt	SKU	Color	List Price
Boulevard® Center Hole Only Pedestal Sink Top and Leg Combination		0641100.020	White	396

Separate Components:

Boulevard® and Tropic® Petite Pedestal Leg	24 lb 10.9 kg	0010000.020	White	151
Boulevard® Center Hole Only Pedestal Sink Top	48 lb 22.0 kg	0641001.020	White	245



Cadet® 4-Inch Centerset Pedestal Sink Top and Leg Combination

- Faucet/soap/accessory ledge with generous shelf area
- Rear overflow
- Supplied with mounting kit
- Design coordinates with Cadet® toilets
- Made of vitreous china

Nominal Dimensions:

24-1/2 in x 20 in x 35 in (622 mm x 508 mm x 889 mm)

Bowl Size:

20 in (wide) 12 in (front to back) 6 in (deep)

Description	Net Wt	SKU	Color	List Price
Cadet® 4-Inch Centerset Pedestal Sink Top and Leg Combination		0236411.020	White	297

Separate Components:

Cadet® 4-Inch Centerset Pedestal Sink Top	41 lb 19.0 kg	0236004.020	White	216
Cadet® Pedestal Leg	27 lb 12.3 kg	731100-400.020	White	81



Cadet® 8 in. Widespread Pedestal Sink Top and Leg Combination

- Faucet/soap/accessory ledge with generous shelf area
- Rear overflow
- Supplied with mounting kit
- Design coordinates with Cadet® toilets
- Made of vitreous china

Nominal Dimensions:

24-1/2 in x 20 in x 35 in (622 mm x 508 mm x 889 mm)

Bowl Size:

20 in (wide) 12 in (front to back) 6 in (deep)

Description	Net Wt	SKU	Color	List Price
Cadet® 8 in. Widespread Pedestal Sink Top and Leg Combination		0236811.020	White	297

Separate Components:

Cadet® 8 in. Widespread Pedestal Sink Top	35 lb 15.9 kg	0236008.020	White	216
Cadet® Pedestal Leg	27 lb 12.3 kg	731100-400.020	White	81



Cadet® Center Hole Only Pedestal Sink Top and Leg Combination

- Faucet/soap/accessory ledge with generous shelf area
- Rear overflow
- Supplied with mounting kit
- Design coordinates with Cadet® toilets
- Made of vitreous china

Nominal Dimensions:

24-1/2 in x 20 in x 35 in (622 mm x 508 mm x 889 mm)

Bowl Size:

20 in (wide) 12 in (front to back) 6 in (deep)

Description	Net Wt	SKU	Color	List Price
Cadet® Center Hole Only Pedestal Sink Top and Leg Combination		0236111.020	White	297

Separate Components:

Cadet® Center Hole Only Pedestal Sink Top	35 lb 15.9 kg	0236001.020	White	216
Cadet® Pedestal Leg	27 lb 12.3 kg	731100-400.020	White	81



Cornice™ 4-Inch Centerset Pedestal Sink Top and Leg Combination

- Corner sink and pedestal
- Corner sink without pedestal can also be wall-hung. Supplied with wall hanger
- Rim slants toward drain for quick drainage
- Twin front concealed overflows
- Made of vitreous china

Nominal Dimensions:

18-7/8 in x 18-7/8 in x 33-3/8 in (479 mm x 479 mm x 847 mm)

Bowl Size:

14 in (wide) 12 in (front to back) 6-1/2 in (deep)

Description	Net Wt	SKU	Color	List Price
Cornice™ 4-Inch Centerset Pedestal Sink Top and Leg Combination		0611400.020	White	473

Separate Components:

Cornice® Pedestal Leg	23 lb 10.7 kg	0028000.020	White	96
Cornice™ 4-Inch Centerset Pedestal Sink Top	32 lb 14.9 kg	0611004.020	White	377



Cornice™ Center Hole Only Pedestal Sink Top and Leg Combination

- Corner sink and pedestal
- Corner sink without pedestal can also be wall-hung. Supplied with wall hanger
- Rim slants toward drain for quick drainage
- Twin front concealed overflows
- Made of vitreous china

Nominal Dimensions:

18-7/8 in x 18-7/8 in x 33-3/8 in (479 mm x 479 mm x 847 mm)

Bowl Size:

14 in (wide) 12 in (front to back) 6-1/2 in (deep)

Description	Net Wt	SKU	Color	List Price
Cornice™ Center Hole Only Pedestal Sink Top and Leg Combination		0611100.020	White	473

Separate Components:

Cornice® Pedestal Leg	23 lb 10.7 kg	0028000.020	White	96
Cornice™ Center Hole Only Pedestal Sink Top	32 lb 14.9 kg	0611001.020	White	377



Edgemere® 4-Inch Centerset Pedestal Sink Top and Leg Combination

- Faucet/soap/accessory ledge with generous shelf area
- Rear overflow
- Supplied with mounting kit
- Design coordinates with Edgemere® collection
- Fine fireclay construction

Nominal Dimensions:

25 in x 19-1/2 in x 35-5/8 in (635 mm x 495 mm x 904 mm)

Bowl Size:

17-1/8 in (wide) 12 in (front to back) 5-1/4 in (deep)



Description	Net Wt	SKU	Color	List Price
Edgemere® 4-Inch Centerset Pedestal Sink Top and Leg Combination		0445400.020	White	314

Separate Components:

Edgemere® Pedestal Leg	34 lb 15.6 kg	0039000.020	White	110
Edgemere® 4-Inch Centerset Pedestal Sink Top	40 lb 18.5 kg	0445004.020	White	204



Edgemere® 8-Inch Widespread Pedestal Sink Top and Leg Combination

- Faucet/soap/accessory ledge with generous shelf area
- Rear overflow
- Supplied with mounting kit
- Design coordinates with Edgemere® collection
- Fine fireclay construction

Nominal Dimensions:

25 in x 19-1/2 in x 35-5/8 in (635 mm x 495 mm x 904 mm)

Bowl Size:

17-1/8 in (wide) 12 in (front to back) 5-1/4 in (deep)



Description	Net Wt	SKU	Color	List Price
Edgemere® 8-Inch Widespread Pedestal Sink Top and Leg Combination		0445800.020	White	314

Separate Components:

Edgemere® Pedestal Leg	34 lb 15.6 kg	0039000.020	White	110
Edgemere® 8-Inch. Widespread Pedestal Sink Top	40 lb 18.5 kg	0445008.020	White	204



Edgemere® Center Hole Only Pedestal Sink Top and Leg Combination

- Faucet/soap/accessory ledge with generous shelf area
- Rear overflow
- Supplied with mounting kit
- Design coordinates with Edgemere® collection
- Fine fireclay construction

Nominal Dimensions:

25 in x 19-1/2 in x 35-5/8 in (635 mm x 495 mm x 904 mm)

Bowl Size:

17-1/8 in (wide) 12 in (front to back) 5-1/4 in (deep)



Description	Net Wt	SKU	Color	List Price
Edgemere® Center Hole Only Pedestal Sink Top and Leg Combination		0445100.020	White	314

Separate Components:

Edgemere® Pedestal Leg	34 lb 15.6 kg	0039000.020	White	110
Edgemere® Center Hole Only Pedestal Sink Top	40 lb 18.5 kg	0445001.020	White	204



24-Inch Evolution® 4-Inch Centerset Pedestal Sink Top and Leg Combination

- Faucet ledge with generous shelf area
- Rear overflow
- Soap/accessory ledge
- Supplied with mounting kit
- Made of vitreous china

Nominal Dimensions:

24 in x 18-3/4 in x 34-1/4 in (609 mm x 476 mm x 869 mm)

Bowl Size:

19-3/4 in (wide) 12 in (front to back) 6 in (deep)

Description	Net Wt	SKU	Color	List Price
24-Inch Evolution® 4-Inch Centerset Pedestal Sink Top and Leg Combination		0468400.020	White	218

Separate Components:

24-Inch Evolution® 4-Inch Centerset Pedestal Sink Top	34 lb 15.4 kg	0468004.020	White	135
Evolution® Pedestal Leg	23 lb 10.5 kg	731150-400.020	White	83



24-Inch Evolution® 8-Inch Widespread Pedestal Sink Top and Leg Combination

- Faucet ledge with generous shelf area
- Rear overflow
- Soap/accessory ledge
- Supplied with mounting kit
- Made of vitreous china

Nominal Dimensions:

24 in x 18-3/4 in x 34-1/4 in (609 mm x 476 mm x 869 mm)

Bowl Size:

19-3/4 in (wide) 12 in (front to back) 6 in (deep)

Description	Net Wt	SKU	Color	List Price
24-Inch Evolution® 8-Inch Widespread Pedestal Sink Top and Leg Combination		0468800.020	White	218

Separate Components:

24-Inch Evolution 8-Inch Widespread Pedestal Sink Top	34 lb 15.4 kg	0468008.020	White	135
Evolution® Pedestal Leg	23 lb 10.5 kg	731150-400.020	White	83



24 in. Evolution® Center Hole Only Pedestal Sink Top and Leg Combination

- Faucet ledge with generous shelf area
- Rear overflow
- Soap/accessory ledge
- Supplied with mounting kit
- Made of vitreous china

Nominal Dimensions:

24 in x 18-3/4 in x 34-1/4 in (609 mm x 476 mm x 869 mm)

Bowl Size:

19-3/4 in (wide) 12 in (front to back) 6 in (deep)

Description	Net Wt	SKU	Color	List Price
24 in. Evolution® Center Hole Only Pedestal Sink Top and Leg Combination		0468100.020	White	218

Separate Components:

24-Inch Evolution® Center Hole Only Pedestal Sink Top	34 lb 15.4 kg	0468001.020	White	135
Evolution® Pedestal Leg	23 lb 10.5 kg	731150-400.020	White	83



22 in. Evolution® 4-Inch Centerset Pedestal Sink Top and Leg Combination

- Faucet ledge with generous shelf area
- Rear overflow
- Soap/accessory ledge
- Supplied with mounting kit
- Made of vitreous china

Nominal Dimensions:

22 in x 17-1/2 in x 34-1/4 in (558 mm x 444 mm x 869 mm)

Bowl Size:

18-1/4 in (wide) 11 in (front to back) 6 in (deep)

Description	Net Wt	SKU	Color	List Price
22 in. Evolution® 4-Inch Centerset Pedestal Sink Top and Leg Combination		0467400.020	White	206

Separate Components:

22-Inch Evolution® 4-Inch Centerset Pedestal Sink Top	34 lb 15.7 kg	0467004.020	White	123
Evolution® Pedestal Leg	23 lb 10.5 kg	731150-400.020	White	83



22-Inch Evolution® 8-Inch Widespread Pedestal Sink Top and Leg Combination

- Faucet ledge with generous shelf area
- Rear overflow
- Soap/accessory ledge
- Supplied with mounting kit
- Made of vitreous china

Nominal Dimensions:

22 in x 17-1/2 in x 34-1/4 in (558 mm x 444 mm x 869 mm)

Bowl Size:

18-1/4 in (wide) 11 in (front to back) 6 in (deep)

Description	Net Wt	SKU	Color	List Price
22-Inch Evolution® 8-Inch Widespread Pedestal Sink Top and Leg Combination		0467800.020	White	206

Separate Components:

22-Inch Evolution® 8-Inch Widespread Pedestal Sink Top	34 lb 15.7 kg	0467008.020	White	123
Evolution® Pedestal Leg	23 lb 10.5 kg	731150-400.020	White	83



22-Inch Evolution® Center Hole Only Pedestal Sink Top and Leg Combination

- Faucet ledge with generous shelf area
- Rear overflow
- Soap/accessory ledge
- Supplied with mounting kit
- Made of vitreous china

Nominal Dimensions:

22 in x 17-1/2 in x 34-1/4 in (558 mm x 444 mm x 869 mm)

Bowl Size:

18-1/4 in (wide) 11 in (front to back) 6 in (deep)

Description	Net Wt	SKU	Color	List Price
22-Inch Evolution® Center Hole Only Pedestal Sink Top and Leg Combination		0467100.020	White	206

Separate Components:

22-Inch. Evolution® Center Hole Only Pedestal Sink Top	34 lb 15.7 kg	0467001.020	White	123
Evolution® Pedestal Leg	23 lb 10.5 kg	731150-400.020	White	83



Portsmouth® 8-Inch Widespread Pedestal Sink Top and Leg Combination

- Turn-of-the-century detailing on sink and pedestal leg
- Faucet ledge with large deck area
- Rear overflow
- Supplied with mounting kit
- Right height for greater comfort during use
- Design coordinates with Portsmouth® Champion® PRO toilets
- Made of vitreous china

Nominal Dimensions:

24-3/8 in x 19-1/2 in x 35-7/16 in (619 mm x 495 mm x 900 mm)

Bowl Size:

19-1/4 in (wide) 11-3/8 in (front to back) 5-3/4 in (deep)



Description	Net Wt	SKU	Color	List Price
Portsmouth® 8-Inch Widespread Pedestal Sink Top and Leg Combination		0555801.020	White	427

Separate Components:

Portsmouth® 8-Inch Widespread Pedestal Sink Top	54 lb 24.9 kg	0555108.020	White	252
Portsmouth® Pedestal Leg	26 lb 12.0 kg	734906-401.020	White	175



Ravenna® 4-Inch Centerset Pedestal Sink Top and Leg Combination

- Contemporary design
- Faucet ledge with generous shelf area
- Rear overflow
- Soap/accessory ledge
- Available integral mounted towel bar (order separately)
- Supplied with mounting kit
- Made of vitreous china

Nominal Dimensions:

24-1/4 in x 20 in x 34 in (615 mm x 508 mm x 863 mm)

Bowl Size:

19-3/8 in (wide) 12.0 in (front to back) 6 in (deep)



Description	Net Wt	SKU	Color	List Price
Ravenna® 4-Inch Centerset Pedestal Sink Top and Leg Combination		0268400.020	White	360

Separate Components:

Ravenna® Pedestal Leg	27 lb 12.3 kg	0041000.020	White	114
Ravenna® 4-Inch Centerset Pedestal Sink Top	41 lb 18.8 kg	0268004.020	White	246
Ravenna® Towel Bar Mounting Kit	0 lb 0.1 kg	▷738520-0070A	No Finish	30

Optional Components:

Ravenna® Semi-Pedestal Sink Integral Towel Bar	1 lb	3520000.002	Polished Chrome	91
	0.8 kg	3520000.295	Brushed Nickel	112



Ravenna® 8-Inch Widespread Pedestal Sink Top and Leg Combination

- Contemporary design
- Faucet ledge with generous shelf area
- Rear overflow
- Soap/accessory ledge
- Available integral mounted towel bar (order separately)
- Supplied with mounting kit
- Made of vitreous china

Nominal Dimensions:

24-1/4 in x 20 in x 34 in (615 mm x 508 mm x 863 mm)

Bowl Size:

19-3/8 in (wide) 12 in (front to back) 6 in (deep)



Description	Net Wt	SKU	Color	List Price
Ravenna® 8-Inch Widespread Pedestal Sink Top and Leg Combination		0268800.020	White	360

Separate Components:

Ravenna® Pedestal Leg	27 lb 12.3 kg	0041000.020	White	114
Ravenna® 8-Inch Widespread Pedestal Sink Top	41 lb 18.8 kg	0268008.020	White	246
Ravenna® Towel Bar Mounting Kit	0 lb 0.1 kg	▷738520-0070A	No Finish	30

Optional Components:

Ravenna® Semi-Pedestal Sink Integral Towel Bar	1 lb 0.8 kg	3520000.002	Polished Chrome	91
		3520000.295	Brushed Nickel	112



Ravenna® Center Hole Only Pedestal Sink Top and Leg Combination

- Contemporary design
- Faucet ledge with generous shelf area
- Rear overflow
- Soap/accessory ledge
- Available integral mounted towel bar (order separately)
- Supplied with mounting kit
- Made of vitreous china

Nominal Dimensions:

24-1/4 in x 20 in x 34 in (615 mm x 508 mm x 863 mm)

Bowl Size:

19-3/8 in (wide) 12.0 in (front to back) 6 in (deep)



Description	Net Wt	SKU	Color	List Price
Ravenna® Center Hole Only Pedestal Sink Top and Leg Combination		0268100.020	White	360

Separate Components:

Ravenna® Pedestal Leg	27 lb 12.3 kg	0041000.020	White	114
Ravenna® Center Hole Only Pedestal Sink Top	41 lb 18.8 kg	0268001.020	White	246
Ravenna® Towel Bar Mounting Kit	0 lb 0.1 kg	▷738520-0070A	No Finish	30

Optional Components:

Ravenna® Semi-Pedestal Sink Integral Towel Bar	1 lb 0.8 kg	3520000.002	Polished Chrome	91
		3520000.295	Brushed Nickel	112

▷ Parts Program (Non-Premier)



Retrospect® 8-Inch Widespread Pedestal Sink Top and Leg Combination

- Authentically styled pedestal
- Hidden front overflow
- Supplied with mounting kit
- Right height for greater comfort during use
- Made of vitreous china

Nominal Dimensions:

27 in x 19-3/4 in x 36 in (685 mm x 501 mm x 914 mm)

Bowl Size:

15-1/2 in (wide) 12 in (front to back) 6-1/8 in (deep)



Description	Net Wt	SKU	Color	List Price
Retrospect® 8-Inch Widespread Pedestal Sink Top and Leg Combination		0282800.020	White	601

Separate Components:

Retrospect® Pedestal Leg	30 lb 13.6 kg	0066000.020	White	219
Retrospect® 8-Inch Widespread Pedestal Sink Top	37 lb 17.1 kg	0282008.020	White	382



Town Square® S 4-Inch Centerset Pedestal Sink Top and Leg Combination

- Raised faucet ledge
- Rear overflow
- Supplied with mounting kit
- Design coordinates with Town Square® S collection
- Right height for greater comfort during use
- Open back pedestal
- Fine fireclay construction

Nominal Dimensions:

30 in x 22-1/2 in x 35 in (762 mm x 571 mm x 889 mm)

Bowl Size:

17-1/2 in (wide) 12-1/4 in (front to back) 5-1/4 in (deep)



Description	Net Wt	SKU	Color	List Price
Town Square® S 4-Inch Centerset Pedestal Sink Top and Leg Combination		0297400.020	White	560

Separate Components:

Town Square® S Pedestal Leg	25 lb 11.3 kg	0056001.020	White	203
Town Square® S 4-Inch Centerset Pedestal Sink Top	41 lb 18.6 kg	0297004.020	White	357



Town Square® S 8-Inch Widespread Pedestal Sink Top and Leg Combination

- Raised faucet ledge
- Rear overflow
- Supplied with mounting kit
- Design coordinates with Town Square® S collection
- Right height for greater comfort during use
- Open back pedestal
- Fine fireclay construction

Nominal Dimensions:

30 in x 22-1/2 in x 35 in (762 mm x 571 mm x 889 mm)

Bowl Size:

17-1/2 in (wide) 12-1/4 in (front to back) 5-1/4 in (deep)



Description	Net Wt	SKU	Color	List Price
Town Square® S 8-Inch Widespread Pedestal Sink Top and Leg Combination		0297800.020	White	568

Separate Components:

Town Square® S Pedestal Leg	25 lb 11.3 kg	0056001.020	White	203
Town Square® S 8-Inch Widespread Pedestal Sink Top	41 lb 18.6 kg	0297008.020	White	365



Town Square® S Center Hole Only Pedestal Sink Top and Leg Combination

- Raised faucet ledge
- Rear overflow
- Supplied with mounting kit
- Design coordinates with Town Square® S collection
- Right height for greater comfort during use
- Open back pedestal
- Fine fireclay construction

Nominal Dimensions:

30 in x 22-1/2 in x 35 in (762 mm x 571 mm x 889 mm)

Bowl Size:

17-1/2 in (wide) 12-1/4 in (front to back) 5-1/4 in (deep)



Description	Net Wt	SKU	Color	List Price
Town Square® S Center Hole Only Pedestal Sink Top and Leg Combination		0297100.020	White	568

Separate Components:

Town Square® S Pedestal Leg	25 lb 11.3 kg	0056001.020	White	203
Town Square® S Center Hole Only Pedestal Sink Top	41 lb 18.6 kg	0297001.020	White	365



Townsend® 8-Inch Widespread Pedestal Sink Top and Leg Combination

- Raised faucet ledge
- Rear overflow
- Supplied with mounting kit
- Design coordinates with Townsend® collection including new furniture offerings
- Right height for greater comfort during use
- Open back pedestal
- Fine fireclay construction

Nominal Dimensions:

30 in x 19-1/2 in x 35-1/4 in (762 mm x 495 mm x 895 mm)

Bowl Size:

19 in (wide) 12-3/4 in (front to back) 5 in (deep)



Description	Net Wt	SKU	Color	List Price
Townsend® 8-Inch Widespread Pedestal Sink Top and Leg Combination		0328800.020	White	507

Separate Components:

Townsend® Pedestal Leg	34 lb 15.6 kg	0039001.020	White	150
Townsend® 8-Inch Widespread Pedestal Sink Top	53 lb 24.1 kg	0328008.020	White	357



Townsend® Center Hole Only Pedestal Sink Top and Leg Combination

- Raised faucet ledge
- Rear overflow
- Supplied with mounting kit
- Design coordinates with Townsend® collection including new furniture offerings
- Right height for greater comfort during use
- Open back pedestal
- Fine fireclay construction

Nominal Dimensions:

30 in x 19-1/2 in x 35-1/4 in (762 mm x 495 mm x 895 mm)

Bowl Size:

19 in (wide) 12-3/4 in (front to back) 5 in (deep)



Description	Net Wt	SKU	Color	List Price
Townsend® Center Hole Only Pedestal Sink Top and Leg Combination		0328100.020	White	507

Separate Components:

Townsend® Pedestal Leg	34 lb 15.6 kg	0039001.020	White	150
Townsend® Center Hole Only Pedestal Sink Top	53 lb 24.1 kg	0328001.020	White	357



Boulevard® 4-Inch Centerset Pedestal Sink Top

- Top is used with pedestal leg 0010000 or countertop-by-others
- Refer to pedestal combo 0641400 for further product details

Nominal Dimensions:

24 in x 19 in (609 mm x 482 mm)

Bowl Size:

17 in (wide) 12-1/2 in (front to back) 5 in (deep)



Description	Net Wt	SKU	Color	List Price
Boulevard® 4-Inch Centerset Pedestal Sink Top	48 lb 22.0 kg	0641004.020	White	245



Boulevard® 8-Inch Widespread Pedestal Sink Top

- Top is used with pedestal leg 0010000 or countertop-by-others
- Refer to pedestal combo 0641800 for further product details

Nominal Dimensions:

24 in x 19 in (609 mm x 482 mm)

Bowl Size:

17 in (wide) 12-1/2 in (front to back) 5 in (deep)



Description	Net Wt	SKU	Color	List Price
Boulevard® 8-Inch Widespread Pedestal Sink Top	48 lb 22.0 kg	0641008.020	White	245



Boulevard® Center Hole Only Pedestal Sink Top

- Top is used with pedestal leg 0010000 or countertop-by-others
- Refer to pedestal combo 0641100 for further product details

Nominal Dimensions:

24 in x 19 in (609 mm x 482 mm)

Bowl Size:

17 in (wide) 12-1/2 in (front to back) 5 in (deep)



Description	Net Wt	SKU	Color	List Price
Boulevard® Center Hole Only Pedestal Sink Top	48 lb 22.0 kg	0641001.020	White	245



Loft® Above Counter Sink

- Above counter basin
- No faucet holes
- Cut-out template supplied
- Fine fireclay construction

Nominal Dimensions:

19-5/8 in x 15-3/4 in (498 mm x 400 mm)

Bowl Size:

18-9/16 in (wide) 14-5/8 in (front to back) 5 in (deep)



Description	Net Wt	SKU	Color	List Price
Loft® Above Counter Sink	28 lb 13.1 kg	0552000.020	White	293



Loft® Above Counter Sink With Center Hole Only

- Above counter sink
- Integral faucet deck for single hole faucet
- Rear overflow
- No glaze on back wall
- Cut-out template supplied
- Fine fireclay construction

Nominal Dimensions:

19-5/8 in x 15-3/4 in (498 mm x 400 mm)

Bowl Size:

18-9/16 in (wide) 14-5/8 in (front to back) 5 in (deep)



Description	Net Wt	SKU	Color	List Price
Loft® Above Counter Sink With Center Hole Only	38 lb 17.4 kg	0552001.020	White	305



Studio® 22 x 18-1/2-Inch Above Counter Sink With Center Hole Only

- Contemporary above countertop rectangular sink design
- Integral faucet deck for single hole faucet
- Rear overflow
- Fits most standard 22" (559 mm) vanities
- No glaze on back wall
- Made of vitreous china

Nominal Dimensions:

22 in x 18-1/2 in (558 mm x 469 mm)

Bowl Size:

19-1/4 in (wide) 12-5/8 in (front to back) 2-5/8 in (deep)



Description	Net Wt	SKU	Color	List Price
Studio® 22 x 18-1/2-Inch Above Counter Sink With Center Hole Only	36 lb 16.7 kg	0621001.020	White	393



Studio® S Above Counter Oval Sink

- Vitreous china top
- Oval shape with center drain
- Design coordinates with Studio S collection
- Supplied with countertop template
- Sink can be used with or without optional furniture

Nominal Dimensions:

14 in x 22-1/2 in (355 mm x 571 mm)

Bowl Size:

21-9/16 in (wide) 13-1/16 in (front to back) 4 in (deep)



Description	Net Wt	SKU	Color	List Price
Studio® S Above Counter Oval Sink	17 lb 7.9 kg	1296000.020	White	370



Studio® S 24-Inch Vitreous China Vanity Sink Top Center Hole Only

- Vitreous china top
- Rectangular vanity sink
- Front overflow
- Design coordinates with the Studio® S Collection of furniture, faucets and accessories
- Supplied with cut-out template
- Sink can be used with or without optional furniture

Nominal Dimensions:

20 in x 24 in (508 mm x 609 mm)

Bowl Size:

19-11/16 in (wide) 14-3/16 in (front to back) 4 in (deep)



Description	Net Wt	SKU	Color	List Price
Studio® S 24-Inch Vitreous China Vanity Sink Top Center Hole Only	26 lb 11.8 kg	1297001.020	White	408



Studio® S 24-Inch Vitreous China Vanity Sink Top 8-Inch Centers

- Vitreous china top
- Rectangular vanity sink
- Front overflow
- Design coordinates with the Studio® S Collection of furniture, faucets and accessories
- Supplied with cut-out template
- Sink can be used with or without optional furniture

Nominal Dimensions:

20 in x 24 in (508 mm x 609 mm)

Bowl Size:

19-11/16 in (wide) 14-3/16 in (front to back) 4 in (deep)



Description	Net Wt	SKU	Color	List Price
Studio® S 24-Inch Vitreous China Vanity Sink Top 8-Inch Centers	26 lb 11.8 kg	1297008.020	White	408



Studio® S 33-Inch Vitreous China Vanity Sink Top Center Hole Only

- Vitreous china top
- Rectangular vanity sink
- Front overflow
- Design coordinates with the Studio® S Collection of furniture, faucets and accessories
- Supplied with cut-out template
- Sink can be used with or without optional furniture

Nominal Dimensions:

20 in x 33 in (508 mm x 838 mm)

Bowl Size:

22-7/16 in (wide) 14-3/16 in (front to back) 4 in (deep)



Description	Net Wt	SKU	Color	List Price
Studio® S 33-Inch Vitreous China Vanity Sink Top Center Hole Only	35 lb 16.2 kg	1298001.020	White	437



Studio® S 33-Inch Vitreous China Vanity Sink Top 8-Inch Centers

- Vitreous china top
- Rectangular vanity sink
- Front overflow
- Design coordinates with the Studio® S Collection of furniture, faucets and accessories
- Supplied with cut-out template
- Sink can be used with or without optional furniture

Nominal Dimensions:

20 in x 33 in (508 mm x 838 mm)

Bowl Size:

22-7/16 in (wide) 14-3/16 in (front to back) 4 in (deep)



Description	Net Wt	SKU	Color	List Price
Studio® S 33-Inch Vitreous China Vanity Sink Top 8-Inch Centers	35 lb 16.2 kg	1298008.020	White	437



Town Square® S Console Vanity Sink Top Center Hole Only

- Faucet holes – center hole only
- Vitreous china top
- Rectangular above counter vanity sink
- Rear overflow
- Design coordinates with Town Square S collection
- Supplied with cut-out template
- Sink can be used with washstand furniture or counter by others including furniture offerings

Nominal Dimensions:

22-3/8 in x 31 in (568 mm x 787 mm)

Bowl Size:

17-1/2 in (wide) 11-15/16 in (front to back) 4-5/8 in (deep)



Description	Net Wt	SKU	Color	List Price
Town Square® S Console Vanity Sink Top Center Hole Only	26 lb 11.8 kg	0298001.020	White	393



Town Square® S Vanity Top with 8-Inch Widespread

- Faucet holes on 8" (203 mm) centers
- Vitreous china top
- Rectangular above counter vanity sink
- Rear overflow
- Design coordinates with Town Square® S collection
- Supplied with cut-out template
- Sink can be used with washstand furniture or counter by others including furniture offerings

Nominal Dimensions:

22-3/8 in x 31 in (568 mm x 787 mm)

Bowl Size:

17-1/2 in (wide) 11-15/16 in (front to back) 4-5/8 in (deep)



Description	Net Wt	SKU	Color	List Price
Town Square® S Vanity Top with 8-Inch Widespread	26 lb 11.8 kg	0298008.020	White	393



Aqualyn® Drop-In Sink With 4-Inch Centerset

- Self-rimming oval drop-in sink
- Tapered edges for style
- Front overflow
- Supplied with cut-out template
- Made of vitreous china

Nominal Dimensions:

20-3/8 in x 17-3/8 in (517 mm x 441 mm)

Bowl Size:

16 in (wide) 10 in (front to back) 5-5/8 in (deep)



Description	Net Wt	SKU	Color	List Price
Aqualyn® Drop-In Sink With 4-Inch Centerset	17 lb 8.0 kg	0476028.020	White	90



Aqualyn® Drop-In Sink With 4-Inch Centerset Less Overflow

- Countertop sink less overflow
- Self-rimming with cut-out template
- Made of vitreous china

Nominal Dimensions:

20-3/8 in x 17-3/8 in (517 mm x 441 mm)

Bowl Size:

16 in (wide) 10 in (front to back) 5-5/8 in (deep)



Description	Net Wt	SKU	Color	List Price
Aqualyn® Drop-In Sink With 4-Inch Centerset Less Overflow	19 lb 9.0 kg	0476928.020	White	114



Aqualyn® Drop-In Sink With 8-Inch Widespread

- Self-rimming oval drop-in sink
- Tapered edges for style
- Front overflow
- Supplied with cut-out template
- Made of vitreous china

Nominal Dimensions:

20-3/8 in x 17-3/8 in (517 mm x 441 mm)

Bowl Size:

16 in (wide) 10 in (front to back) 5-5/8 in (deep)



Description	Net Wt	SKU	Color	List Price
Aqualyn® Drop-In Sink With 8-Inch Widespread	19 lb 9.0 kg	0475020.020	White	90



Aqualyn® Drop-In Sink With Center Hole Only

- Self-rimming oval drop-in sink
- Tapered edges for style
- Front overflow
- Supplied with cut-out template
- Made of vitreous china

Nominal Dimensions:

20-3/8 in x 17-3/8 in (517 mm x 441 mm)

Bowl Size:

16 in (wide) 10 in (front to back) 5-5/8 in (deep)



Description	Net Wt	SKU	Color	List Price
Aqualyn® Drop-In Sink With Center Hole Only	19 lb 9.0 kg	0475047.020	White	89



Rondalyn® Drop-In Sink With 4-Inch Centerset

- Self-rimming round drop-in sink
- Tapered edges for style
- Front overflow
- Supplied with cut-out template
- Made of vitreous china

Nominal Dimensions:

19-1/8 in x 19-1/8 in (485 mm x 485 mm)

Bowl Size:

15 in (wide) 12-1/8 in (front to back) 5-3/4 in (deep)



Description	Net Wt	SKU	Color	List Price
Rondalyn® Drop-In Sink With 4-Inch Centerset	19 lb 9.0 kg	0491019.020	White	90



Studio Carre® Drop-In Sink With Center Hole Only

- Square self-rimming, drop-in sink with rectangular curved bottom bowl
- Rear overflow
- Supplied with cut-out template
- Made of vitreous china

Nominal Dimensions:

16-1/4 in x 16-1/4 in (412 mm x 412 mm)

Bowl Size:

12-1/2 in (wide) 9-3/8 in (front to back) 4-3/4 in (deep)



Description	Net Wt	SKU	Color	List Price
Studio Carre® Drop-In Sink With Center Hole Only	17 lb 7.7 kg	0642001.020	White	247



Studio® Drop-In Sink With 8-Inch Widespread

- Rectangular self-rimming, drop-in sink with rectangular curved bottom bowl
- Front overflow
- Supplied with cut-out template
- Made of vitreous china

Nominal Dimensions:

21 in x 17-3/4 in (533 mm x 450 mm)

Bowl Size:

18 in (wide) 12 in (front to back) 4-1/2 in (deep)



Description	Net Wt	SKU	Color	List Price
Studio® Drop-In Sink With 8-Inch Widespread	27 lb 12.5 kg	0643008.020	White	324



Studio® Drop-In Sink With Center Hole Only

- Rectangular self-rimming, drop-in sink with rectangular curved bottom bowl
- Front overflow
- Supplied with cut-out template
- Made of vitreous china

Nominal Dimensions:

21 in x 17-3/4 in (533 mm x 450 mm)

Bowl Size:

18 in (wide) 12 in (front to back) 4-1/2 in (deep)



Description	Net Wt	SKU	Color	List Price
Studio® Drop-In Sink With Center Hole Only	27 lb 12.5 kg	0643001.020	White	324



Town Square® S Drop-In Sink With 4-Inch Centerset

- Self-rimming fireclay drop-in sink
- Decorative rim detailing with tapered interior bowl design
- Front overflow
- Supplied with cut-out template
- Design coordinated to Town Square® S suite

Nominal Dimensions:

24 in x 19-1/16 in (609 mm x 484 mm)

Bowl Size:

17-7/16 in (wide) 11-7/8 in (front to back) 5-1/2 in (deep)



Description	Net Wt	SKU	Color	List Price
Town Square® S Drop-In Sink With 4-Inch Centerset	34 lb 15.7 kg	1203004.020	White	316



Town Square® S Drop-In Sink With 8-Inch Widespread

- Self-rimming fireclay drop-in sink
- Decorative rim detailing with tapered interior bowl design
- Front overflow
- Supplied with cut-out template
- Design coordinated to Town Square® S suite

Nominal Dimensions:

24 in x 19-1/16 in (609 mm x 484 mm)

Bowl Size:

17-7/16 in (wide) 11-7/8 in (front to back) 5-1/2 in (deep)



Description	Net Wt	SKU	Color	List Price
Town Square® S Drop-In Sink With 8-Inch Widespread	34 lb 15.7 kg	1203008.020	White	316



Town Square® S Drop-In Sink With Center Hole Only

- Self-rimming fireclay drop-in sink
- Decorative rim detailing with tapered interior bowl design
- Front overflow
- Supplied with cut-out template
- Design coordinated to Town Square® S suite

Nominal Dimensions:

24 in x 19-1/16 in (609 mm x 484 mm)

Bowl Size:

17-7/16 in (wide) 11-7/8 in (front to back) 5-1/2 in (deep)



Description	Net Wt	SKU	Color	List Price
Town Square® S Drop-In Sink With Center Hole Only	34 lb 15.7 kg	1203001.020	White	316



Boulevard® Under Counter Sink

- Rectangular under counter mount sink with unique tapered interior bowl
- Unglazed rim
- Front overflow
- Supplied with under counter mounting kit and template
- Made of vitreous china

Nominal Dimensions:

20-1/4 in x 16 in (514 mm x 406 mm x 8 in)

Bowl Size:

17 in (wide) 13 in (front to back) 6 in (deep)



Description	Net Wt	SKU	Color	List Price
Boulevard® Under Counter Sink	23 lb 10.4 kg	0610000.020	White	339

Separate Components:

Under Counter Mounting Kit	0 lb 0.1 kg	▷047194-0070A	No Finish	21
----------------------------	----------------	---------------	-----------	----



Edgemere® Under Counter Sink

- Rectangular under counter mount sink
- Unglazed rim
- Front overflow
- Supplied with kit for under counter installation
- Made of vitreous china

Nominal Dimensions:

18-1/2 in x 16-1/8 in (469 mm x 409 mm)

Bowl Size:

16-3/4 in (wide) 14-3/8 in (front to back) 3 in (deep)



Description	Net Wt	SKU	Color	List Price
Edgemere® Under Counter Sink	14 lb 6.5 kg	0545000.020	White	186

Separate Components:

Under Counter Mounting Kit	0 lb 0.1 kg	▷047194-0070A	No Finish	21
----------------------------	----------------	---------------	-----------	----



Orbit® Under Counter Sink

- Round under counter mount sink
- Unglazed rim
- Front overflow
- Supplied with under counter mounting kit and template
- Made of vitreous china

Nominal Dimensions:

15-1/2 in x 15-1/2 in (393 mm x 393 mm x 6-1/8 in)

Bowl Size:

12-3/4 in (wide) 12-3/4 in (front to back) 4-3/8 in (deep)



Description	Net Wt	SKU	Color	List Price
Orbit® Under Counter Sink	17 lb 8.0 kg	0630000.020	White	257

Separate Components:

Under Counter Mounting Kit	0 lb 0.1 kg	▷047194-0070A	No Finish	21
----------------------------	----------------	---------------	-----------	----

▷ Parts Program (Non-Premier)



Ovalyn™ Large Under Counter Sink

- Under counter mount sink
- Unglazed rim
- Front overflow
- Supplied with mounting kit and template
- Made of vitreous china

Nominal Dimensions:

17-3/8 in x 21-1/2 in (441 mm x 546 mm)

Bowl Size:

19 in (wide) 15-3/8 in (front to back) 5-1/2 in (deep)

Description	Net Wt	SKU	Color	List Price
Ovalyn™ Large Under Counter Sink	23 lb 10.4 kg	0497221.020	White	93
		0497221.021	Bone	255
		0497221.222	Linen	255

Separate Components:

Under Counter Mounting Kit	0 lb 0.1 kg	▷047194-0070A	No Finish	21
----------------------------	----------------	---------------	-----------	----



Ovalyn™ Large Under Counter Sink With Glazed Underside

- Under counter mount sink with glazed underside
- Unglazed rim
- Front overflow
- Supplied with mounting kit and template
- Made of vitreous china

Nominal Dimensions:

17-3/8 in x 21-1/2 in (441 mm x 546 mm)

Bowl Size:

19 in (wide) 15-3/8 in (front to back) 4 in (deep)

Description	Net Wt	SKU	Color	List Price
Ovalyn™ Large Under Counter Sink With Glazed Underside	23 lb 10.4 kg	0497300.020	White	136

Separate Components:

Under Counter Mounting Kit	0 lb 0.1 kg	▷047194-0070A	No Finish	21
----------------------------	----------------	---------------	-----------	----



Ovalyn™ Medium Under Counter Sink

- Under counter mount sink
- Unglazed rim
- Front overflow
- Supplied with mounting kit and template
- Made of vitreous china

Nominal Dimensions:

16 in x 19-1/4 in (406 mm x 488 mm)

Bowl Size:

17 in (wide) 14 in (front to back) 5-1/2 in (deep)

Description	Net Wt	SKU	Color	List Price
Ovalyn™ Medium Under Counter Sink	18 lb 8.5 kg	0496221.020	White	89
		0496221.021	Bone	161
		0496221.222	Linen	161

Separate Components:

Under Counter Mounting Kit	0 lb 0.1 kg	▷047194-0070A	No Finish	21
----------------------------	----------------	---------------	-----------	----

▷ Parts Program (Non-Premier)



Ovalyn™ Medium Under Counter Sink With Glazed Underside

- Under counter mount sink with glazed underside
- Unglazed rim
- Front overflow
- Supplied with mounting kit and template
- Made of vitreous china

Nominal Dimensions:

16 in x 19-1/4 in (406 mm x 488 mm)

Bowl Size:

17 in (wide) 14 in (front to back) 5-1/2 in (deep)

Description	Net Wt	SKU	Color	List Price
Ovalyn™ Medium Under Counter Sink With Glazed Underside	18 lb 8.5 kg	0496300.020	White	133

Separate Components:

Under Counter Mounting Kit	0 lb 0.1 kg	▷047194-0070A	No Finish	21
----------------------------	----------------	---------------	-----------	----



Ovalyn™ Small Under Counter Sink

- Under counter mount sink
- Unglazed rim
- Front overflow
- Supplied with mounting kit and template
- Made of vitreous china

Nominal Dimensions:

14-1/8 in x 17-1/8 in (358 mm x 434 mm)

Bowl Size:

15-1/16 in (wide) 12-1/16 in (front to back) 5-1/2 in (deep)

Description	Net Wt	SKU	Color	List Price
Ovalyn™ Small Under Counter Sink	17 lb 7.7 kg	0495221.020	White	89
		0495221.021	Bone	161
		0495221.222	Linen	161

Separate Components:

Under Counter Mounting Kit	0 lb 0.1 kg	▷047194-0070A	No Finish	21
----------------------------	----------------	---------------	-----------	----



Ovalyn™ Small Under Counter Sink With Glazed Underside

- Under counter mount sink with glazed underside
- Unglazed rim
- Front overflow
- Supplied with mounting kit and template
- Made of vitreous china

Nominal Dimensions:

14-3/16 in x 17-1/8 in (360 mm x 434 mm)

Bowl Size:

15-1/16 in (wide) 12-1/16 in (front to back) 5-1/2 in (deep)

Description	Net Wt	SKU	Color	List Price
Ovalyn™ Small Under Counter Sink With Glazed Underside	17 lb 7.7 kg	0495300.020	White	133

Separate Components:

Under Counter Mounting Kit	0 lb 0.1 kg	▷047194-0070A	No Finish	21
----------------------------	----------------	---------------	-----------	----



Ovalyn™ Universal Access Undermount Sink

- Under counter mount sink
- Unglazed rim
- Rear overflow
- Supplied with under counter mounting kit and template
- Made of vitreous china

Nominal Dimensions:

15-3/4 in x 19-1/2 in (400 mm x 495 mm)

Bowl Size:

16-3/4 in (wide) 13-1/4 in (front to back) 4 in (deep)

Description	Net Wt	SKU	Color	List Price
Ovalyn™ Universal Access Undermount Sink	15 lb 6.8 kg	9482000.020	White	126

Separate Components:

Under Counter Mounting Kit	0 lb 0.1 kg	▷047194-0070A	No Finish	21
----------------------------	----------------	---------------	-----------	----



Studio Carre® Under Counter Sink

- Square under counter mount sink
- Sink less faucet deck
- Position overflow as either front or rear
- Supplied with under counter mounting kit and template
- Made of vitreous china

Nominal Dimensions:

16 in x 16 in (406 mm x 406 mm)

Bowl Size:

13-1/2 in (wide) 13-1/2 in (front to back) 4-3/4 in (deep)



Description	Net Wt	SKU	Color	List Price
Studio Carre® Under Counter Sink	17 lb 7.7 kg	0426000.020	White	239

Separate Components:

Under Counter Mounting Kit	0 lb 0.1 kg	▷047194-0070A	No Finish	21
----------------------------	----------------	---------------	-----------	----



Studio® Large Under Counter Sink

- Rectangular under counter mount sink
- Unglazed rim
- Front overflow
- Supplied with under counter mounting kit and template
- Made of vitreous china

Nominal Dimensions:

23-5/8 in x 16-5/8 in (600 mm x 422 mm)

Bowl Size:

21-1/16 in (wide) 14 in (front to back) 6-1/4 in (deep)



Description	Net Wt	SKU	Color	List Price
Studio® Large Under Counter Sink	23 lb 10.4 kg	0618000.020	White	309

Separate Components:

Under Counter Mounting Kit	0 lb 0.1 kg	▷047194-0070A	No Finish	21
----------------------------	----------------	---------------	-----------	----

▷ Parts Program (Non-Premier)



Studio® Under Counter Sink

- Rectangular under counter mount sink
- Unglazed rim
- Front overflow
- Supplied with under counter mounting kit and template
- Made of vitreous china

Nominal Dimensions:

19-3/4 in x 13-3/4 in (501 mm x 349 mm)

Bowl Size:

18 in (wide) 12 in (front to back) 6-7/16 in (deep)



Description	Net Wt	SKU	Color	List Price
Studio® Under Counter Sink	22 lb 10.0 kg	0614000.020	White	274

Separate Components:

Under Counter Mounting Kit	0 lb 0.1 kg	▷047194-0070A	No Finish	21
----------------------------	----------------	---------------	-----------	----



Studio® Under Counter Sink With Glazed Underside

- Rectangular under counter mount sink
- Unglazed rim
- Front overflow
- Supplied with under counter mounting kit and template
- Made of vitreous china

Nominal Dimensions:

19-3/4 in x 13-3/4 in (501 mm x 349 mm)

Bowl Size:

18 in (wide) 12 in (front to back) 6-7/16 in (deep)



Description	Net Wt	SKU	Color	List Price
Studio® Under Counter Sink With Glazed Underside	22 lb 10.0 kg	0614300.020	White	338

Separate Components:

Under Counter Mounting Kit	0 lb 0.1 kg	▷047194-0070A	No Finish	21
----------------------------	----------------	---------------	-----------	----



Townsend® Under Counter Sink

- Rectangular under counter mount sink
- Unglazed rim
- Front overflow
- Supplied with under counter mounting kit and template
- Design coordinates with Townsend® collection including furniture offerings
- Made of vitreous china

Nominal Dimensions:

19-1/2 in x 13-5/8 in (495 mm x 346 mm)

Bowl Size:

17-3/4 in (wide) 11-5/8 in (front to back) 4-1/2 in (deep)



Description	Net Wt	SKU	Color	List Price
Townsend® Under Counter Sink	17 lb 7.7 kg	0330000.020	White	258

Separate Components:

Under Counter Mounting Kit	0 lb 0.1 kg	▷047194-0070A	No Finish	21
----------------------------	----------------	---------------	-----------	----

▷ Parts Program (Non-Premier)



Ravenna® 4-Inch Centerset Wall-Hung Sink and Semi-Pedestal Leg Combination

- Contemporary wall-hung design
- Semi-pedestal P-trap cover for ease of cleaning
- Faucet ledge with generous shelf area for accessories
- Rear overflow
- Available integral mounted towel bar (order separately)
- Supplied with mounting kit
- Made of vitreous china

Nominal Dimensions:

24-1/4 in x 20 in x 34 in (615 mm x 508 mm x 863 mm)

Bowl Size:

19-3/8 in (wide) 12.0 in (front to back) 6 in (deep)



Description	Net Wt	SKU	Color	List Price
Ravenna® 4-Inch Centerset Wall-Hung Sink and Semi-Pedestal Leg Combination		0268444.020	White	438

Separate Components:

Ravenna® Semi-Pedestal Leg	14 lb 6.4 kg	0044000.020	White	192
Ravenna® 4-Inch Centerset Pedestal Sink Top	41 lb 18.8 kg	0268004.020	White	246
Ravenna® Towel Bar Mounting Kit	0 lb 0.1 kg	▷738520-0070A	No Finish	30

Optional Components:

Ravenna® Semi-Pedestal Sink Integral Towel Bar	1 lb 0.8 kg	3520000.002	Polished Chrome	91
		3520000.295	Brushed Nickel	112



Ravenna® 8-Inch Widespread Wall-Hung Sink and Semi-Pedestal Leg Combination

- Contemporary wall-hung design
- Semi-pedestal P-trap cover for ease of cleaning
- Faucet ledge with generous shelf area for accessories
- Rear overflow
- Available integral mounted towel bar (order separately)
- Supplied with mounting kit
- Made of vitreous china

Nominal Dimensions:

24-1/4 in x 20 in x 34 in (615 mm x 508 mm x 863 mm)

Bowl Size:

19-3/8 in (wide) 12.0 in (front to back) 6 in (deep)



Description	Net Wt	SKU	Color	List Price
Ravenna® 8-Inch Widespread Wall-Hung Sink and Semi-Pedestal Leg Combination		0268888.020	White	438

Separate Components:

Ravenna® Semi-Pedestal Leg	14 lb 6.4 kg	0044000.020	White	192
Ravenna® 8-Inch Widespread Pedestal Sink Top	41 lb 18.8 kg	0268008.020	White	246
Ravenna® Towel Bar Mounting Kit	0 lb 0.1 kg	▷738520-0070A	No Finish	30

Optional Components:

Ravenna® Semi-Pedestal Sink Integral Towel Bar	1 lb 0.8 kg	3520000.002	Polished Chrome	91
		3520000.295	Brushed Nickel	112

▷ Parts Program (Non-Premier)



Ravenna® Center Hole Only Wall-Hung Sink and Semi-Pedestal Leg Combination

- Contemporary wall-hung design
- Semi-pedestal P-trap cover for ease of cleaning
- Faucet ledge with generous shelf area for accessories
- Rear overflow
- Available integral mounted towel bar (order separately)
- Supplied with mounting kit
- Made of vitreous china

Nominal Dimensions:

24-1/4 in x 20 in x 34 in (615 mm x 508 mm x 863 mm)

Bowl Size:

19-3/8 in (wide) 12 in (front to back) 6 in (deep)



Description	Net Wt	SKU	Color	List Price
Ravenna® Center Hole Only Wall-Hung Sink and Semi-Pedestal Leg Combination		0268144.020	White	438
Separate Components:				
Ravenna® Semi-Pedestal Leg	14 lb 6.4 kg	0044000.020	White	192
Ravenna® Center Hole Only Pedestal Sink Top	41 lb 18.8 kg	0268001.020	White	246
Ravenna® Towel Bar Mounting Kit	0 lb 0.1 kg	▷738520-0070A	No Finish	30
Optional Components:				
Ravenna® Semi-Pedestal Sink Integral Towel Bar	1 lb 0.8 kg	3520000.002	Polished Chrome	91
		3520000.295	Brushed Nickel	112

Toilets

When considering a toilet, technology reigns. Does it meet your functional needs? Is it efficient? Does it have additional features to make daily maintenance easy? The American Standard collection includes a vast array of toilet designs to meet every requirement you demand.



Toilets

No-Touch Flush for Home and Business

Cadet® Touchless Toilets are chair height, elongated styles designed for comfort and ease of use. Available with smooth, skirted sides to conceal trapway for easy cleaning, or with exposed trapway less seat, both feature our exclusive EverClean® surface to inhibit the growth of bacteria, and use 1.28 gpf volume to conserve water without sacrificing performance.



2989709



Optional Tank Cover Lock Device (TCLD) tank 4000769 with locking sensor tab now available for “vandal resistant” commercial bathroom applications.



215AA709



2-1/2 inch diameter sensor module can be installed on wall within 3 feet of toilet or on top of toilet tank with supplied screws or backing tape.



When installed with recommended seats listed below, top of seat is 17" to 19" (432 to 483 mm) from the finished floor.



TOUCHLESS FLUSH — Wave hand slowly within 1-1/2 inches of sensor face for approximately two seconds to trigger a powerful flush



MANUAL FLUSH — Push and hold the left side actuator button for approximately two seconds ensuring continual operation in the event batteries need replacing



BATTERIES INCLUDED — One-year battery life powered by 3 AAA sensor and 4 AA control module batteries, based on an average of 12 flushes per day



Includes signage to educate users how to activate the no-touch flush technology.

Fixture Color



020 White

CADET TOUCHLESS TOILET COMBINATION	COMBINATION	BOWL	TANK	SLOW-CLOSE SEAT
Concealed Trap Elongated With Seat	2989709	3075000	4000709	502465G (packed with bowl)
Concealed Trap Elongated With TCLD Option and Seat	2989769	3075000	4000769	502465G (packed with bowl)
Exposed Trap Elongated Less Seat	215AA709	3517A101	4000709	5503A00B (order separately)
Exposed Trap Elongated With TCLD Option Less Seat	215AA769	3517A101	4000769	5503A00B (order separately)

Toilets

Studio[®] S Low Profile One-Piece Toilet – Powerful Yet Quiet Flush



Ultra-High Efficiency Toilet (UHET) uses a water saving, MaP PREMIUM listed, 1.0 gallon per flush (gpf) volume and obtains the best 1,000 g flush score*



PowerFlo™ technology requires no batteries or electrical power and uses a standard bathroom inlet water connection



CleanCurve® rim eliminates dirt buildup and smooth-sided, concealed trapway cleans easily



Slow-close seat included

12-inch rough configuration

Fits in the space of a traditional elongated toilet

Hidden supply-line installation option



Limited Lifetime Warranty on chinaware, 5-year warranty on all mechanical parts



How Does the PowerFlo™ Technology Work?

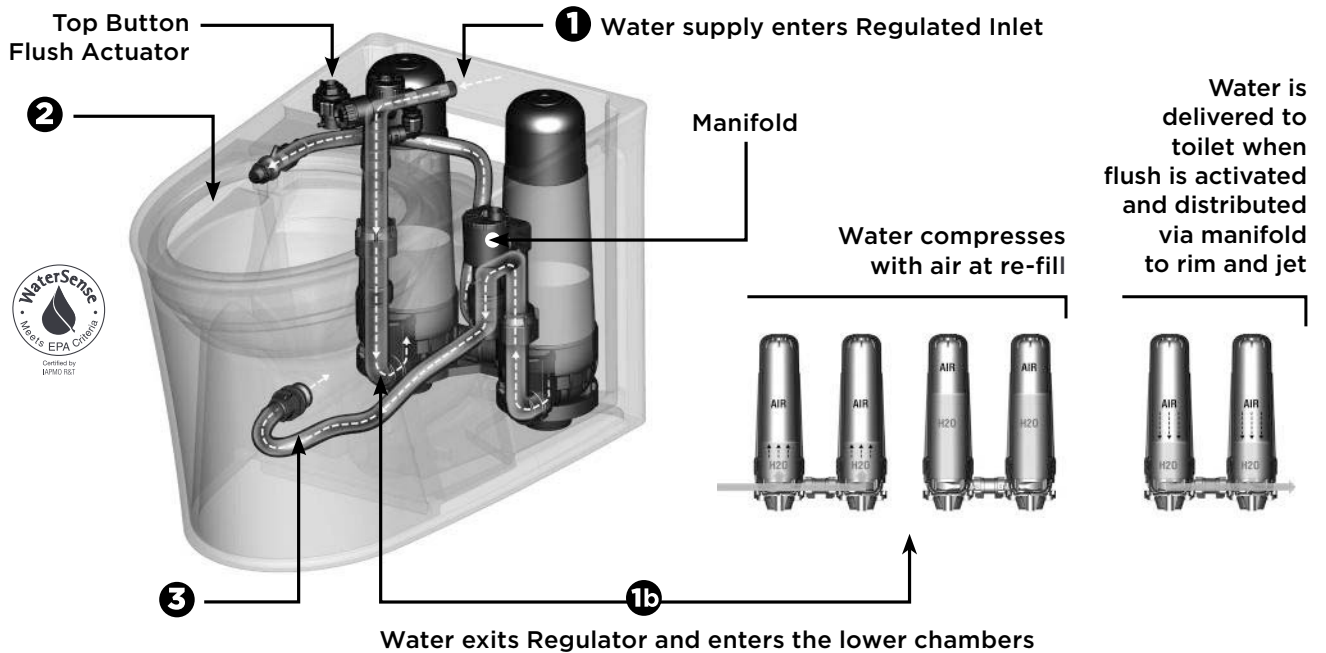

The water from the water supply line enters **1** at the regulated inlet and flows to the self-contained flushing chambers located strategically behind the toilet bowl area, compresses with air, and is directed to the toilet via manifold and two water pathways.







As soon as the toilet's top flush actuator is pressed, water from **2** one pathway is directed into the rim providing a thorough CleanCurve rim wash while water in the second pathway goes directly to the **3** bowl jet which initiates the powerful siphon based flush that completely evacuates the bowl each and every time.

*MaP testing performed by IAPMO R&T Lab. MaP report conducted by Gauley Associates Ltd and Koeller and Company.

Toilets

Standard Toilets Overview

One-Piece Toilets

 Studio® S	 Boulevard®	 Town Square® S	 Tropic®	 Townsend® VorMax®	 Champion® 4	 Loft®
 Compact Cadet® 3	 Colony®	 Cadet® Bidet	 Advanced Clean®			

Two-Piece Toilets

 Cadet® Touchless Concealed	 Cadet® Touchless Exposed	 Studio® S	 VorMax®	 Heritage® VorMax®	 Town Square® S Concealed	 Town Square® S
 Portsmouth® Champion® PRO	 Retrospect® Champion® PRO	 Champion® PRO	 Studio® Dual Flush	 H2Option® Dual Flush	 H2Optimum®	 Triangle Cadet® PRO
 Edgemere® SpaLet® Bundle	 Cadet® PRO	 Cadet® Ovation	 Edgemere® Dual Flush	 Edgemere®	 Colony®3	

High Efficiency (1.28 gpf/4.8 Lpf) Toilet



Boulevard® One-Piece 1.28 gpf/4.8 Lpf Chair Height Elongated Toilet With Seat

- LXP® (Luxury Performance) toilet
- 12" (305 mm) rough-in
- Chair Height elongated siphon action bowl with smooth-sided, concealed trapway
- High efficiency, ultra-low consumption (1.28 gpf/4.8 Lpf), utilizes 20% less water
- Meets EPA WaterSense® criteria
- EverClean® Antimicrobial Surface
- PowerWash® rim helps clean bowl with each flush
- 16-1/2" (419 mm) rim height for accessible applications
- 2" (51 mm) trapway
- 3" (76 mm) flush valve
- Includes slow-close seat and cover with concealed seat ring and easy lift-off feature
- Two color-matched bolt hole covers
- 10-year warranty
- Design coordinates with Studio® and Boulevard® lavatories

Nominal Dimensions:

29-1/16 in x 14-1/2 in x 30-1/2 in (738 mm x 368 mm x 774 mm)



Description	Net Wt	SKU	Color	List Price
Boulevard® One-Piece 1.28 gpf/4.8 Lpf Chair Height Elongated Toilet With Seat	105 lb 47.7 kg	2891128.020	White	1,128
Boulevard® One-Piece 1.28 gpf/4.8 Lpf Chair Height Right-Hand Trip Lever Elongated Toilet With Seat	106 lb 48.4 kg	2891813.020	White	1,133

Separate Components:

Telescoping Slow-Close Easy Lift-Off Elongated Toilet Seat	4 lb 2.0 kg	5025A65G.020	White	131
Boulevard® One-Piece Toilet Tank Cover	7 lb 3.3 kg	735148-400.020	White	119
Left-Hand Trip Lever	0 lb 0.3 kg	▷7381064-2240A	Oil Rubbed Bronze	113
		▷7381064-2430A	Matte Black	84
		▷7381064-2950A	Brushed Nickel	67
Right-Hand Trip Lever	0 lb 0.1 kg	▷7381847-200.0020A	Polished Chrome	54
		▷7381847-200.2950A	Brushed Nickel	90

▷ Parts Program (Non-Premier)

ADA when installed with provided seat, top of seat is 17" to 19" (432 to 483 mm) from the finished floor.

Meets all ANSI/ASME Low Consumption, Water Conservation Requirements.

High Efficiency (1.6 gpf/6.0 Lpf) Full Flush and (1.1 gpf/4.4 Lpf) Conserving Flush Toilet



Boulevard® One-Piece Dual Flush 1.6 gpf/6.0 Lpf and 1.1 gpf/4.2 Lpf Chair Height Elongated Toilet With Seat

- LXP® (Luxury Performance) toilet
- 12" (305 mm) rough-in
- Chair Height elongated siphon action dual flush bowl with smooth-sided, concealed trapway
- High efficiency, low consumption, full flush (1.6 gpf/6.0 Lpf) or conserving flush (1.1 gpf/4.2 Lpf), utilizes 31% less water
- Meets EPA WaterSense® criteria
- EverClean® Antimicrobial Surface
- PowerWash® rim helps clean bowl with each flush
- 16-1/2" (419 mm) rim height
- 2" (51 mm) trapway
- 3" (76 mm) flush valve
- 9" x 8" (229 x 203 mm) water surface area
- Includes slow-close seat and cover with concealed seat ring and easy lift-off feature
- Chrome plated top-mounted push button actuator
- Two color-matched bolt hole covers
- 10-year warranty
- Design coordinates with Studio® and Boulevard® lavatories

Nominal Dimensions:

29-3/4 in x 14-1/2 in x 30-1/2 in (755 mm x 368 mm x 774 mm)



Description	Net Wt	SKU	Color	List Price
Boulevard® One-Piece Dual Flush 1.6 gpf/6.0 Lpf and 1.1 gpf/4.2 Lpf Chair Height Elongated Toilet With Seat	106 lb 48.4 kg	2891200.020	White	1,234

Separate Components:

Telescoping Slow-Close Easy Lift-Off Elongated Toilet Seat	4 lb 2.0 kg	5025A65G.020	White	131
Boulevard® One-Piece Dual Flush Toilet Tank Cover	10 lb 4.5 kg	735169-400.020	White	113
Top-of-Tank Actuator, Dual Flush	0 lb 0.1 kg	▷7381203-200.2950A	Brushed Nickel	109
		▷7381203-200.2430A	Matte Black	132
		▷7381203-200.0020A	Polished Chrome	15

▷ Parts Program (Non-Premier)

Meets all ANSI/ASME Low Consumption, Water Conservation Requirements.

High Efficiency (1.28 gpf/4.8 Lpf) Toilet



Compact Cadet® 3 One-Piece 1.28 gpf/4.8 Lpf Chair Height Elongated Toilet With Seat

- Chair Height elongated bowl
- Space saving compact elongated bowl fits in the space of a round front
- 12" (305 mm) rough-in
- High efficiency, ultra-low consumption (1.28 gpf/4.8 Lpf), utilizes 20% less water
- Meets EPA WaterSense® criteria
- 16-½" (419 mm) bowl rim height for accessible application
- EverClean® Antimicrobial Surface
- Includes slow-close seat and cover with EverClean® Surface
- Seat features unique sanitary seat lift tab
- 3" (76 mm) flush valve
- 9" x 8" (229 x 203 mm) water surface area
- 2-1/8" (54 mm) trapway
- Two color-matched bolt caps
- Five-year warranty

Nominal Dimensions:

27-11/16 in x 15 in x 27-3/8 in (703 mm x 381 mm x 695 mm)



Description	Net Wt	SKU	Color	List Price
Compact Cadet® 3 One-Piece 1.28 gpf/4.8 Lpf Chair Height Elongated Toilet With Seat	92 lb 41.9 kg	2403128.020	White	630
		2403128.021	Bone	921
		2403128.222	Linen	921
Compact Cadet® 3 One-Piece 1.28 gpf/4.8 Lpf Chair Height Right-Hand Trip Lever Elongated Toilet With Seat		2403813.020	White	769
Separate Components:				
Cadet® 3 Slow-Close Elongated Toilet Seat	4 lb 2.0 kg	5350110.020	White	81
		5350110.021	Bone	110
		5350110.222	Linen	110
Compact Cadet® 3 One-Piece Toilet Tank Cover	15 lb 6.8 kg	735125-400.020	White	151
		735125-400.021	Bone	188
		735125-400.222	Linen	188
Left-Hand Trip Lever	0 lb 0.0 kg	▷738903-0020A	Polished Chrome	25
		▷738903-0200A	White	41
		▷738903-2220A	Linen	47
		▷738903-2430A	Matte Black	100
		▷738903-2950A	Brushed Nickel	35
Right-Hand Trip Lever		▷738919-0020A	Polished Chrome	25

▷ Parts Program (Non-Premier)

ADA when installed with provided seat, top of seat is 17" to 19" (432 to 483 mm) from the finished floor.

Meets all ANSI/ASME Low Consumption, Water Conservation Requirements.

Low Consumption (1.6 gpf/6.0 Lpf) Toilets ✦



Champion® 4 One-Piece 1.6 gpf/6.0 Lpf Chair Height Elongated Toilet With Seat

- Chair Height elongated siphon action jetted bowl
- EverClean® Antimicrobial Surface
- Low consumption (1.6 gpf/6.0 Lpf)
- 4" (102 mm) piston-action Accelerator™ flush valve
- 12" (305 mm) rough-in
- 2-3/8" (60 mm) fully-glazed trapway
- 16-1/2" (419 mm) rim height
- 100% factory flush tested
- Two color-matched bolt caps
- Includes color-matched Champion slow-close toilet seat
- 10-year warranty

Nominal Dimensions:

28-13/16 in x 16-3/4 in x 29-1/2 in (731 mm x 425 mm x 749 mm)



Description	Net Wt	SKU	Color	List Price
Champion® 4 One-Piece 1.6 gpf/6.0 Lpf Chair Height Elongated Toilet With Seat	115 lb	2034314.020	White	838
	52.2 kg	2034314.021	Bone	1,048
		2034314.222	Linen	1,048

Separate Components:

Champion® Slow-Close & Easy Lift-Off Elongated Toilet Seat	3 lb	5321A65CT.020	White	98
	1.6 kg	5321A65CT.021	Bone	123
		5321A65CT.222	Linen	123
Champion® 4 One-Piece Toilet Tank Cover	7 lb	735105-400.020	White	79
	3.6 kg	735105-400.021	Bone	101
		735105-400.222	Linen	101
Left-Hand Trip Lever	0 lb	▷738772-0020A	Polished Chrome	27
	0.1 kg	▷738772-0990A	Polished Brass	43
		▷738772-2950A	Brushed Nickel	44

▷ Parts Program (Non-Premier)

ADA when installed with provided seat, top of seat is 17" to 19" (432 to 483 mm) from the finished floor.

Meets all ANSI/ASME Low Consumption, Water Conservation Requirements.

✦Check your local codes to determine if 1.6 gpf/6.0 Lpf toilets are allowed in your area.

Low Consumption (1.6 gpf/6.0 Lpf) Toilets ✦



Champion® 4 One-Piece 1.6 gpf/6.0 Lpf Standard Height Elongated Toilet With Seat

- Elongated siphon action jetted bowl
- EverClean® Antimicrobial Surface
- Low consumption (1.6 gpf/6.0 Lpf)
- 4" (102 mm) piston-action Accelerator™ flush valve
- 12" (305 mm) rough-in
- 2-3/8" (60 mm) fully-glazed trapway
- 15" (381 mm) rim height
- 100% factory flush tested
- Two color-matched bolt caps
- Includes color-matched Champion slow-close toilet seat
- 10-year warranty

Nominal Dimensions:

29-3/4 in x 17-3/4 in x 29-1/2 in (755 mm x 450 mm x 749 mm)



Description	Net Wt	SKU	Color	List Price
Champion® 4 One-Piece 1.6 gpf/6.0 Lpf Standard Height Elongated Toilet With Seat	109 lb 49.5 kg	2004314.020	White	772
Separate Components:				
Champion® Slow-Close & Easy Lift-Off Elongated Toilet Seat	3 lb 1.6 kg	5321A65CT.020	White	98
Champion® 4 One-Piece Toilet Tank Cover	7 lb 3.6 kg	735105-400.020	White	79
Left-Hand Trip Lever	0 lb 0.1 kg	▷738772-0020A	Polished Chrome	27
		▷738772-0990A	Polished Brass	43
		▷738772-2950A	Brushed Nickel	44

▷ Parts Program (Non-Premier)

Meets all ANSI/ASME Low Consumption, Water Conservation Requirements.

✦ Check your local codes to determine if 1.6 gpf/6.0 Lpf toilets are allowed in your area.

High Efficiency (1.28 gpf/4.8 Lpf) Toilet



Colony® One-Piece 1.28 gpf/4.8 Lpf Chair Height Elongated Toilet With Seat

- Chair Height elongated bowl
- 12" (305 mm) rough-in
- High efficiency, ultra-low consumption (1.28 gpf/4.8 Lpf), utilizes 20% less water
- Meets EPA WaterSense® criteria
- 16-1/2" (419 mm) bowl rim height for accessible application
- Includes slow-close seat and cover
- 3" (76 mm) flush valve
- 9" x 8" (229 x 203 mm) water surface area
- 2" (51 mm) trapway
- Chrome plated trip lever
- Two color-matched bolt caps
- Two-year warranty

Nominal Dimensions:

28-7/8 in x 16-3/8 in x 26-3/16 in (733 mm x 415 mm x 665 mm)



Description	Net Wt	SKU	Color	List Price
Colony® One-Piece 1.28 gpf/4.8 Lpf Chair Height Elongated Toilet With Seat	71 lb 32.3 kg	2961A104SC.020	White	588

Separate Components:

Cardiff™ Slow-Close Elongated Toilet Seat	3 lb 1.5 kg	5257A65MT.020	White	71
Colony® One-Piece Toilet Tank Cover	7 lb 3.4 kg	735228-400.020	White	
Left-Hand Trip Lever	1 lb 0.5 kg	▷7381951-200.0020A	Polished Chrome	12

▷ Parts Program (Non-Premier)

ADA when installed with provided seat, top of seat is 17" to 19" (432 to 483 mm) from the finished floor.

Meets all ANSI/ASME Low Consumption, Water Conservation Requirements.

High Efficiency (1.28 gpf/4.8 Lpf) Toilet



Loft® One-Piece 1.28 gpf/4.8 Lpf Chair Height Elongated Toilet With Seat

- Chair Height elongated bowl
- Space saving compact design with side trip lever
- 12" (305 mm) rough-in
- High efficiency, ultra-low consumption (1.28 gpf/4.8 Lpf), utilizes 20% less water
- Meets EPA WaterSense® criteria
- 16-½" (419 mm) bowl rim height for accessible application
- EverClean® Antimicrobial Surface
- Includes slow-close telescoping toilet seat and cover with EverClean® Surface
- 3" (76 mm) flush valve
- 9" x 8" (229 x 203 mm) water surface area
- 2-1/8" (54 mm) trapway
- Two color-matched bolt caps
- Five-year warranty

Nominal Dimensions:

27-11/16 in x 14 in x 28-5/8 in (703 mm x 355 mm x 727 mm)



Description	Net Wt	SKU	Color	List Price
Loft® One-Piece 1.28 gpf/4.8 Lpf Chair Height Elongated Toilet With Seat	89 lb 40.6 kg	2535128.020	White	750

Separate Components:

Telescoping Slow-Close Easy Lift-Off Elongated Toilet Seat	4 lb 2.0 kg	5025A65G.020	White	131
Loft® One-Piece Toilet Tank Cover	10 lb 4.5 kg	735182-400.020	White	139
Left-Hand Trip Lever	0 lb 0.1 kg	▷7381286-200.0020A	Polished Chrome	32

▷ Parts Program (Non-Premier)

ADA when installed with provided seat, top of seat is 17" to 19" (432 to 483 mm) from the finished floor.

Meets all ANSI/ASME Low Consumption, Water Conservation Requirements.

Ultra-High Efficiency (1.0 gpf/3.8 Lpf) Toilet



Studio® S One-Piece 1.0 gpf/3.8 Lpf Chair Height Elongated Toilet With Seat

- High performance, quiet PowerFlo™ flushing system requires no electrical power and uses standard inlet water connection
- 12" (305 mm) rough-in
- Chair Height elongated siphon action bowl with smooth-sided, concealed trapway
- Ultra-High Efficiency Toilet (UHET) 1.0 gpf/3.8 Lpf
- Meets EPA WaterSense® and MaP PREMIUM criteria
- CleanCurve® rim eliminates area where dirt and build-up hide
- Generous 8-1/4" x 9-1/4" (210 x 235 mm) water surface area
- 2" (51 mm) fully glazed trapway
- Color-matched tank top actuator
- Includes slow-close seat and cover with easy lift-off feature



Nominal Dimensions:

29-1/2 in x 15-7/8 in x 16-3/4 in (749 mm x 403 mm x 425 mm)

Description	Net Wt	SKU	Color	List Price
Studio® S One-Piece 1.0 gpf/3.8 Lpf Chair Height Elongated Toilet With Seat	109 lb 49.7 kg	2548A100.020	White	1,469

Separate Components:

Studio® S Elongated Toilet Seat	3 lb 1.7 kg	▷5041A65G.0200A	White	127
---------------------------------	----------------	-----------------	-------	-----

▷ Parts Program (Non-Premier)

ADA when installed with provided seat, top of seat is 17" to 19" (432 to 483 mm) from the finished floor.

Meets all ANSI/ASME Low Consumption, Water Conservation Requirements.

*MaP testing performed by IAPMO R&T Lab. MaP report conducted by Gauley Associates Ltd. and Koeller and Company.

High Efficiency (1.28 gpf/4.8 Lpf) Toilet



Town Square® S One-Piece 1.28 gpf/4.8 Lpf Chair Height Elongated Toilet With Seat

- LXP® (Luxury Performance) toilet
- 12" (305 mm) rough-in
- Chair Height elongated siphon action bowl with smooth-sided, concealed trapway
- High efficiency, ultra-low consumption (1.28 gpf/4.8 Lpf), utilizes 20% less water
- Meets EPA WaterSense® criteria
- Classic American traditional styling
- EverClean® Antimicrobial Surface
- PowerWash® rim helps clean bowl with each flush
- 16-1/2" (419 mm) rim height for accessible applications
- 2" (51 mm) trapway
- 3" (76 mm) flush valve
- Chrome trip lever matches Town Square® S faucets and accessories
- Includes slow-close seat and cover with concealed seat ring and easy lift-off feature
- Two color-matched bolt hole covers
- 10-year warranty
- Design coordinates with Town Square® S suite

Nominal Dimensions:

30-1/2 in x 16-3/8 in x 30-9/16 in (774 mm x 415 mm x 776 mm)



Description	Net Wt	SKU	Color	List Price
Town Square® S One-Piece 1.28 gpf/4.8 Lpf Chair Height Elongated Toilet With Seat	107 lb 48.6 kg	2851A104.020	White	1,058
		2851A104.222	Linen	1,322
Town Square® S One-Piece 1.28 gpf/4.8 Lpf Chair Height Right-Hand Trip Lever Elongated Toilet With Seat		2851A105.020	White	1,064

Separate Components:

Traditional Slow-Close & Easy Lift-Off Elongated Toilet Seat	6 lb 3.0 kg	5020A65G.020	White	131
		5020A65G.222	Linen	162
Town Square® S One-Piece Toilet Tank Cover	9 lb 4.3 kg	735226-400.020	White	117
		735226-400.222	Linen	146
Left-Hand Trip Lever	0 lb 0.3 kg	▷7381105-0020A	Polished Chrome	44
		▷7381105-0130A	Polished Nickel	58
		▷7381105-2240A	Oil Rubbed Bronze	109
		▷7381105-2780A	Legacy Bronze	72
		▷7381105-2950A	Brushed Nickel	63
Right-Hand Trip Lever	0 lb 0.2 kg	▷7381020-0020A	Polished Chrome	44

▷ Parts Program (Non-Premier)

ADA when installed with provided seat, top of seat is 17" to 19" (432 to 483 mm) from the finished floor.

Meets all ANSI/ASME Low Consumption, Water Conservation Requirements.

High Efficiency (1.28 gpf/4.8 Lpf) Toilet



Townsend VorMax One-Piece 1.28 gpf/4.8 Lpf Chair Height Elongated Toilet with Seat

- Two patented flush valves and maximum rinsing power for the cleanest flush*
- 12" (305 mm) rough-in
- Chair Height elongated siphon action bowl
- High efficiency, ultra-low consumption (1.28 gpf/4.8 Lpf), utilizes 20% less water
- Meets EPA WaterSense® criteria
- EverClean® Antimicrobial Surface
- CleanCurve® rim eliminates rim area where dirt and build-up hide
- 16-1/2" (419 mm) rim height for accessible applications
- 2-1/16" (52 mm) trapway
- Dual injection flush valves
- Includes slow-close seat and cover
- Two color-matched bolt caps
- 10-year warranty
- Design coordinates with Townsend® suite

Nominal Dimensions:

29-1/2 in x 16-7/8 in x 29-3/4 in (749 mm x 428 mm x 755 mm)



Description	Net Wt	SKU	Color	List Price
Townsend VorMax One-Piece 1.28 gpf/4.8 Lpf Chair Height Elongated Toilet with Seat	100 lb 45.8 kg	2922A104.020	White	886

Separate Components:

Contemporary Slow-Close & Easy Lift-Off Elongated Toilet Seat for VorMax® CleanCurve® Style Rims	3 lb 1.7 kg	5055A65C.020	White	108
Townsend® VorMax® One-Piece Toilet Tank Cover	7 lb 3.5 kg	735212-400.020	White	111
Left-Hand Trip Lever	0 lb 0.1 kg	▷7381735-200.0020A	Polished Chrome	79
		▷7381735-200.0130A	Polished Nickel	74
		▷7381735-200.2430A	Matte Black	101
		▷7381735-200.2780A	Legacy Bronze	105
		▷7381735-200.2950A	Brushed Nickel	85

▷ Parts Program (Non-Premier)

ADA when installed with provided seat, top of seat is 17" to 19" (432 to 483 mm) from the finished floor.

Meets all ANSI/ASME Low Consumption, Water Conservation Requirements.

*Compared to American Standard Champion toilets.

High Efficiency (1.28 gpf/4.8 Lpf) Toilet



Tropic® One-Piece 1.28 gpf/4.8 Lpf Chair Height Elongated Toilet With Seat

- LXP® (Luxury Performance) toilet
- 12" (305 mm) rough-in
- Chair Height elongated siphon action bowl with smooth-sided, concealed trapway
- High efficiency, ultra-low consumption (1.28 gpf/4.8 Lpf), utilizes 20% less water
- Meets EPA WaterSense® criteria
- EverClean® Antimicrobial Surface
- PowerWash® rim helps clean bowl with each flush
- 16-1/2" (419 mm) rim height for accessible applications
- 2" (51 mm) trapway
- 3" (76 mm) flush valve
- Chrome trip lever
- Includes slow-close seat and cover with concealed seat ring and easy lift-off feature
- Two color-matched bolt hole covers
- 10-year warranty
- Transitional design coordinates with Tropic® lavatories and faucets

Nominal Dimensions:

29-3/4 in x 16-3/4 in x 30-1/2 in (755 mm x 425 mm x 774 mm)



Description	Net Wt	SKU	Color	List Price
Tropic® One-Piece 1.28 gpf/4.8 Lpf Chair Height Elongated Toilet With Seat	97 lb 44.4 kg	2786128.020	White	1,128

Separate Components:

Transitional Slow-Close & Easy Lift-Off Elongated Toilet Seat	6 lb 3.0 kg	5024A65G.020	White	131
Tropic® One-Piece Toilet Tank Cover	7 lb 3.3 kg	735147-400.020	White	119
Left-Hand Trip Lever	0 lb 0.4 kg	▷7381097-2950A	Brushed Nickel	89

▷ Parts Program (Non-Premier)

ADA when installed with provided seat, top of seat is 17" to 19" (432 to 483 mm) from the finished floor.

Meets all ANSI/ASME Low Consumption, Water Conservation Requirements.

High Efficiency (1.28 gpf/4.8 Lpf) Toilet



Cadet® Touchless Chair Height Elongated Toilet With Concealed Trapway

- Simple hand wave touchless flush technology
- 2-1/2" (64 mm) diameter sensor module can be installed on wall within 3 feet of toilet or on top of toilet tank itself
- Siphon action jetted bowl with smooth-sided, concealed trapway
- Ultra-low consumption (1.28 gpf/4.8 Lpf) utilizes 20% less water
- Meets EPA WaterSense® criteria
- 12" (305 mm) rough installation
- 3" (76 mm) flush valve with integrated fill valve
- 2-1/8" (54 mm) trapway bowl with EverClean® surface included
- Obtains best 1,000g MaP flush score*
- Includes top mount, slow-close seat and cover with easy lift-off feature for cleaning
- Powered by 3AAA sensor and 4AA control module batteries (included)
- Convenient, manual Polished Chrome override flush actuator on side of tank
- Limited lifetime warranty on chinaware, limited five-year warranty on all mechanical parts, and limited one-year warranty on electronic parts and seat

Nominal Dimensions:

30-3/16 in x 15-13/16 in x 30-11/16 in (766 mm x 401 mm x 779 mm)



Description	Net Wt	SKU	Color	List Price
Cadet® Touchless Chair Height Elongated Toilet With Concealed Trapway		2989709.020	White	726
Cadet® Touchless Chair Height Elongated Skirted Toilet with Seat and Locking Device		2989769.020	White	762

Separate Components:

Cadet® 3 FloWise® Skirted Chair Height Elongated Bowl With Seat	72 lb 33.1 kg	3075000.020	White	471
Cadet® Touchless 1.28 gpf Single Flush Toilet Tank Only	29 lb 13.3 kg	4000709.020	White	255
Cadet Touchless 1.28 gpf Single Flush Toilet Tank Only with Locking Device		4000769.020	White	291
Studio 12-Inch Rough Tank Cover	7 lb 3.3 kg	735158-400.020	White	71
Touchless Sensor	0 lb 0.2 kg	▷7381981-201.0070A	No Finish	97
Manual Override Button	0 lb 0.0 kg	▷7381982-201.0020A	Polished Chrome	9
		▷7381982-201.0200A	White	9

Optional Components:

Transitional Slow-Close & Easy Lift-Off Elongated Toilet Seat	6 lb 3.0 kg	5024A65G.020	White	131
---	----------------	--------------	-------	-----

▷ Parts Program (Non-Premier)

ADA when installed with provided seat, top of seat is 17" to 19" (432 to 483 mm) from the finished floor.

Meets all ANSI/ASME Low Consumption, Water Conservation Requirements.

High Efficiency (1.28 gpf/4.8 Lpf) Toilets



Cadet®3 FloWise™ Skirted Two-Piece 1.28 gpf/4.8 Lpf Chair Height Elongated Toilet With Seat

- Combination bowl and tank, with seat
- 12" (305 mm) rough-in
- High efficiency, ultra-low consumption (1.28 gpf/4.8 Lpf), utilizes 20% less water
- Meets EPA WaterSense® criteria
- EverClean® Antimicrobial Surface
- 16-1/2" (419 mm) rim height for accessible application
- Siphon action jetted bowl with smooth-sided, concealed trapway
- 2-1/8" (54 mm) fully glazed trapway
- 9" x 8" (229 x 203 mm) water surface area
- PowerWash® rim helps clean bowl with each flush
- 3" (76 mm) flush valve
- Chrome plated trip lever
- Includes top-mount slow-close seat and cover with easy lift off feature
- Two color-matched bolt hole covers
- Five-year warranty

Nominal Dimensions:

30-1/4 in x 15-3/4 in x 30-3/4 in (768 mm x 400 mm x 781 mm)



Description	Net Wt	SKU	Color	List Price
Cadet®3 FloWise™ Skirted Two-Piece 1.28 gpf/4.8 Lpf Chair Height Elongated Toilet With Seat		2989101.020	White	607
Cadet® 3 FloWise® Skirted Two-Piece 1.28 gpf/4.8 Lpf Chair Height Right-Hand Trip Lever Elongated Toilet With Seat		2989813.020	White	614

Separate Components:

Cadet® 3 FloWise® Skirted Chair Height Elongated Bowl With Seat	72 lb 33.1 kg	3075000.020	White	471
Cadet® 3 FloWise® 1.28 gpf/4.8 Lpf 12-Inch Rough Tank	29 lb 13.3 kg	4000101.020	White	136
Cadet® 3 FloWise® 1.28 gpf/4.8 Lpf 12-Inch Rough Right Hand Trip Lever Tank		4000813.020	White	143
Cadet® 3 FloWise® 12-Inch Rough Toilet Tank Cover	7 lb 3.3 kg	735154-400.020	White	75
Transitional Slow-Close & Easy Lift-Off Elongated Toilet Seat	6 lb 3.0 kg	5024A65G.020	White	131
Left-Hand Trip Lever	0 lb 0.0 kg	▷738903-0020A	Polished Chrome	25
		▷738903-0200A	White	41
		▷738903-2430A	Matte Black	100
		▷738903-2950A	Brushed Nickel	35
Right-Hand Trip Lever		▷738919-0020A	Polished Chrome	25

▷ Parts Program (Non-Premier)

ADA when installed with provided seat, top of seat is 17" to 19" (432 to 483 mm) from the finished floor.

Meets all ANSI/ASME Low Consumption, Water Conservation Requirements.

High Efficiency (1.28 gpf/4.8 Lpf) Toilets



Cadet® 3 FloWise™ Skirted Two-Piece 1.28 gpf/4.8 Lpf Chair Height Round Front Toilet With Seat

- Combination bowl and tank, with seat
- 12" (305 mm) rough-in
- High efficiency, ultra-low consumption (1.28 gpf/4.8 Lpf), utilizes 20% less water
- Meets EPA WaterSense® criteria
- EverClean® Antimicrobial Surface
- 16-½" (419 mm) rim height for accessible application
- Siphon action jetted bowl with smooth-sided, concealed trapway
- 2-1/8" (54 mm) fully glazed trapway
- 9" x 8" (229 x 203 mm) water surface area
- PowerWash® rim scrubs bowl with each flush
- 3" (76 mm) flush valve
- Chrome plated trip lever
- Includes top-mount slow-close seat and cover with easy lift off feature
- Two color-matched bolt hole covers
- Five-year warranty

Nominal Dimensions:

28-1/4 in x 15-3/4 in x 30-3/4 in (717 mm x 400 mm x 781 mm)



Description	Net Wt	SKU	Color	List Price
Cadet® 3 FloWise™ Skirted Two-Piece 1.28 gpf/4.8 Lpf Chair Height Round Front Toilet With Seat		2988101.020	White	577
Cadet® 3 FloWise® Skirted Two-Piece 1.28 gpf/4.8 Lpf Chair Height Right-Hand Trip Lever Round Front Toilet With Seat		2988813.020	White	584

Separate Components:

Cadet® 3 FloWise® Skirted Chair Height Round Front Bowl With Seat	68 lb 31.1 kg	3053000.020	White	441
Cadet® 3 FloWise® 1.28 gpf/4.8 Lpf 12-Inch Rough Tank	29 lb 13.3 kg	4000101.020	White	136
Cadet® 3 FloWise® 1.28 gpf/4.8 Lpf 12-Inch Rough Right Hand Trip Lever Tank		4000813.020	White	143
Cadet® 3 FloWise® 12-Inch Rough Toilet Tank Cover	7 lb 3.3 kg	735154-400.020	White	75
Transitional Slow-Close & Easy Lift-Off Round Front Toilet Seat	4 lb 2.1 kg	5024B65G.020	White	120
Left-Hand Trip Lever	0 lb 0.0 kg	▷738903-0020A	Polished Chrome	25
		▷738903-0200A	White	41
		▷738903-2430A	Matte Black	100
		▷738903-2950A	Brushed Nickel	35
Right-Hand Trip Lever		▷738919-0020A	Polished Chrome	25

▷ Parts Program (Non-Premier)

ADA when installed with provided seat, top of seat is 17" to 19" (432 to 483 mm) from the finished floor.

Meets all ANSI/ASME Low Consumption, Water Conservation Requirements.

High Efficiency (1.28 gpf/4.8 Lpf) Toilet



Cadet® Touchless Chair Height Elongated Toilet Less Seat

- Combination tank and bowl, less seat
- Simple hand wave touchless flush technology
- 2-1/2" (64 mm) diameter sensor module can be installed on wall within 3 feet of toilet or on top of toilet tank itself
- Siphon action jetted bowl
- Ultra-low consumption (1.28 gpf/4.8 Lpf) utilizes 20% less water
- Meets EPA WaterSense® criteria
- 12" (305 mm) rough installation
- 3" (76 mm) flush valve with integrated fill valve
- 2-1/8" (54 mm) trapway bowl with EverClean® surface included
- Obtains best 1,000g MaP flush score*
- Powered by 3AAA sensor and 4AA control module batteries (included)
- Convenient, manual Polished Chrome override flush actuator on side of tank
- Limited lifetime warranty on chinaware, limited five-year warranty on all mechanical parts, and limited one-year warranty on electronic parts

Nominal Dimensions:

30-3/16 in x 15-13/16 in x 30-11/16 in (766 mm x 401 mm x 779 mm)



Description	Net Wt	SKU	Color	List Price
Cadet® Touchless Chair Height Elongated Toilet Less Seat		215AA709.020	White	519
Cadet® Touchless Chair Height Elongated Toilet with Locking Device - Less Seat		215AA769.020	White	555
Separate Components:				
Cadet® PRO Chair Height Elongated Toilet Bowl Only	55 lb 25.0 kg	3517A101.020	White	264
* Cadet® Touchless 1.28 gpf Single Flush Toilet Tank Only	29 lb 13.3 kg	4000709.020	White	255
* Cadet Touchless 1.28 gpf Single Flush Toilet Tank Only with Locking Device		4000769.020	White	291
* Studio 12-Inch Rough Tank Cover	7 lb 3.3 kg	735158-400.020	White	71
Touchless Sensor	0 lb 0.2 kg	▷7381981-201.0070A	No Finish	97
Manual Override Button	0 lb 0.0 kg	▷7381982-201.0020A	Polished Chrome	9
		▷7381982-201.0200A	White	9
Optional Components:				
* Transitional Slow-Close Elongated Toilet Seat	2 lb 1.3 kg	5503A00B.020	White	57

▷ Parts Program (Non-Premier)

* Tank and seat only are Premier

ADA when installed with provided seat, top of seat is 17" to 19" (432 to 483 mm) from the finished floor.

Meets all ANSI/ASME Low Consumption, Water Conservation Requirements.

Cadet® PRO

High Efficiency (1.28 gpf/4.8 Lpf) Toilets



Cadet® PRO Two-Piece 1.28 gpf/4.8 Lpf Chair Height Elongated Toilet Less Seat

- Combination bowl and tank, less seat
- 12" (305 mm) rough-in
- High efficiency, ultra-low consumption (1.28 gpf/4.8 Lpf), utilizes 20% less water
- Meets EPA WaterSense® criteria
- Trade specific tank
- PowerWash® rim helps clean bowl with each flush
- Metal trip lever
- Metal shank fill valve
- Includes EZ-Install Tools
- EverClean® Antimicrobial Surface
- 16-1/2" (419 mm) rim height for accessible application
- 2-1/8" (54 mm) fully glazed trapway
- 9" x 8" (229 x 203 mm) water surface area
- 3" (76 mm) flush valve
- Five-year warranty

Nominal Dimensions:

30-1/4 in x 17-1/4 in x 30-1/4 in (768 mm x 438 mm x 768 mm)



Description	Net Wt	SKU	Color	List Price
Cadet® PRO Two-Piece 1.28 gpf/4.8 Lpf Chair Height Elongated Toilet Less Seat		215AA104.020	White	413
		215AA104.021	Bone	509
		215AA104.222	Linen	509
Cadet® PRO Two-Piece 1.28 gpf/4.8 Lpf Chair Height Elongated Right-Hand Trip Lever Toilet Less Seat		215AA105.020	White	421

Separate Components:

Cadet® PRO Chair Height Elongated Toilet Bowl Only	55 lb 25.0 kg	3517A101.020	White	264
		3517A101.021	Bone	327
		3517A101.222	Linen	327
Cadet® PRO 1.28 gpf/4.8 Lpf 12-Inch Rough Tank	27 lb 12.6 kg	4188A104.020	White	149
		4188A104.021	Bone	182
		4188A104.222	Linen	182
Cadet® PRO 1.28 gpf/4.8 Lpf 12-Inch Rough Right-Hand Trip Lever Tank		4188A105.020	White	157
Cadet PRO® 12-Inch Rough Toilet Tank Cover	7 lb 3.3 kg	735172-400.020	White	94
		735172-400.021	Bone	119
		735172-400.222	Linen	119
Left-Hand Trip Lever	0 lb 0.2 kg	▷7381231-200.0020A	Polished Chrome	37
		▷7381231-200.0130A	Polished Nickel	46
		▷7381231-200.0200A	White	45
		▷7381231-200.0990A	Polished Brass	45
		▷7381231-200.2240A	Oil Rubbed Bronze	67
		▷7381231-200.2780A	Legacy Bronze	108
Right-Hand Trip Lever	0 lb 0.0 kg	▷7381231-200.2950A	Brushed Nickel	54
		▷7381231-201.0020A	Polished Chrome	37
		▷7381231-201.2950A	Brushed Nickel	54

▷ Parts Program (Non-Premier)

Other seat options

Additional tanks

ADA when installed with provided seat, top of seat is 17" to 19" (432 to 483 mm) from the finished floor.

Meets all ANSI/ASME Low Consumption, Water Conservation Requirements.

Low Consumption (1.6 gpf/6.0 Lpf) Toilets ✦



Cadet® PRO Two-Piece 1.6 gpf/6.0 Lpf Chair Height Elongated Toilet Less Seat

- Combination bowl and tank, less seat
- 12" (305 mm) rough-in
- Low consumption (1.6 gpf/6.0 Lpf)
- Trade specific tank
- PowerWash® rim helps clean bowl with each flush
- Metal trip lever
- Metal shank fill valve
- Includes EZ-Install Tools
- EverClean® Antimicrobial Surface
- 16-1/2" (419 mm) rim height for accessible application
- 2-1/8" (54 mm) fully glazed trapway
- 9" x 8" (229 x 203 mm) water surface area
- 3" (76 mm) flush valve
- Five-year warranty

Nominal Dimensions:

29-1/8 in x 17-3/8 in x 30-3/8 in (739 mm x 441 mm x 771 mm)



Description	Net Wt	SKU	Color	List Price
Cadet® PRO Two-Piece 1.6 gpf/6.0 Lpf Chair Height Elongated Toilet Less Seat		215AA004.020	White	413
		215AA004.021	Bone	509
		215AA004.222	Linen	509
Cadet® PRO Two-Piece 1.6 gpf/6.0 Lpf Chair Height Elongated Right-Hand Trip Lever Toilet Less Seat		215AA005.020	White	421

Separate Components:

Cadet® PRO Chair Height Elongated Toilet Bowl Only	55 lb 25.0 kg	3517A101.020	White	264
		3517A101.021	Bone	327
		3517A101.222	Linen	327
Cadet® PRO 1.6 gpf/6.0 Lpf 12-Inch Rough Tank	27 lb 12.6 kg	4188A004.020	White	149
		4188A004.021	Bone	182
		4188A004.222	Linen	182
Cadet® PRO 1.6 gpf/6.0 Lpf 12-Inch Rough Right-Hand Trip Lever Tank		4188A005.020	White	157
Cadet PRO® 12-Inch Rough Toilet Tank Cover	7 lb 3.3 kg	735172-400.020	White	94
		735172-400.021	Bone	119
		735172-400.222	Linen	119
Left-Hand Trip Lever	0 lb 0.2 kg	▷7381231-200.0020A	Polished Chrome	37
		▷7381231-200.0130A	Polished Nickel	46
		▷7381231-200.0200A	White	45
		▷7381231-200.0990A	Polished Brass	45
		▷7381231-200.2240A	Oil Rubbed Bronze	67
	0 lb 0.1 kg	▷7381231-200.2780A	Legacy Bronze	108
		▷7381231-200.2950A	Brushed Nickel	54
Right-Hand Trip Lever	0 lb 0.2 kg	▷7381231-201.2950A	Brushed Nickel	54

Optional Components:

Cardiff™ Slow-Close Elongated Toilet Seat	3 lb 1.5 kg	5257A65MT.020	White	71
		5257A65MT.021	Bone	78
		5257A65MT.222	Linen	78

▷ Parts Program (Non-Premier)

Other seat options

Additional tanks

ADA when installed with provided seat, top of seat is 17" to 19" (432 to 483 mm) from the finished floor.

Meets all ANSI/ASME Low Consumption, Water Conservation Requirements.

✦ Check your local codes to determine if 1.6 gpf/6.0 Lpf toilets are allowed in your area.

High Efficiency (1.28 gpf/4.8 Lpf) Toilets



Cadet® PRO Two-Piece 1.28 gpf/4.8 Lpf Chair Height Round Front Toilet Less Seat

- Combination bowl and tank, less seat
- 12" (305 mm) rough-in
- High efficiency, ultra-low consumption (1.28 gpf/4.8 Lpf), utilizes 20% less water
- Meets EPA WaterSense® criteria
- Trade specific tank
- PowerWash® rim helps clean bowl with each flush
- Metal trip lever
- Metal shank fill valve
- Includes EZ-Install Tools
- EverClean® Antimicrobial Surface
- 16-1/2" (419 mm) rim height for accessible application
- 2-1/8" (54 mm) fully glazed trapway
- 9" x 8" (229 x 203 mm) water surface area
- 3" (76 mm) flush valve
- Five-year warranty

Nominal Dimensions:

28-1/4 in x 17-1/4 in x 30-1/4 in (717 mm x 438 mm x 768 mm)



Description	Net Wt	SKU	Color	List Price
Cadet® PRO Two-Piece 1.28 gpf/4.8 Lpf Chair Height Round Front Toilet Less Seat		215BA104.020	White	396
		215BA104.021	Bone	489
		215BA104.222	Linen	489
Cadet® PRO Two-Piece 1.28 gpf/4.8 Lpf Chair Height Round Front Right-Hand Trip Lever Toilet Less Seat		215BA105.020	White	404

Separate Components:

Cadet® PRO Chair Height Round Front Bowl	52 lb 23.9 kg	3517B101.020	White	247
		3517B101.021	Bone	307
		3517B101.222	Linen	307
Cadet® PRO 1.28 gpf/4.8 Lpf 12-Inch Rough Tank	27 lb 12.6 kg	4188A104.020	White	149
		4188A104.021	Bone	182
		4188A104.222	Linen	182
Cadet® PRO 1.28 gpf/4.8 Lpf 12-Inch Rough Right-Hand Trip Lever Tank		4188A105.020	White	157
Cadet PRO® 12-Inch Rough Toilet Tank Cover	7 lb 3.3 kg	735172-400.020	White	94
		735172-400.021	Bone	119
		735172-400.222	Linen	119
Left-Hand Trip Lever	0 lb 0.2 kg	▷7381231-200.0020A	Polished Chrome	37
		▷7381231-200.0130A	Polished Nickel	46
		▷7381231-200.0200A	White	45
		▷7381231-200.0990A	Polished Brass	45
		▷7381231-200.2240A	Oil Rubbed Bronze	67
Right-Hand Trip Lever	0 lb 0.0 kg	▷7381231-200.2780A	Legacy Bronze	108
		▷7381231-200.2950A	Brushed Nickel	54
		▷7381231-201.2950A	Brushed Nickel	54

Optional Components:

Cardiff™ Slow-Close Round Front Toilet Seat	3 lb 1.4 kg	5259B65MT.020	White	65
		5259B65MT.021	Bone	71
		5259B65MT.222	Linen	71

▷ Parts Program (Non-Premier)

Other seat options

Additional tanks

ADA when installed with provided seat, top of seat is 17" to 19" (432 to 483 mm) from the finished floor.

Meets all ANSI/ASME Low Consumption, Water Conservation Requirements.

Low Consumption (1.6 gpf/6.0 Lpf) Toilets ✦



Cadet® PRO Two-Piece 1.6 gpf/6.0 Lpf Chair Height Round Front Toilet Less Seat

- Combination bowl and tank, less seat
- 12" (305 mm) rough-in
- Low consumption (1.6 gpf/6.0 Lpf)
- Trade specific tank
- PowerWash® rim helps clean bowl with each flush
- Metal trip lever
- Metal shank fill valve
- Includes EZ-Install Tools
- EverClean® Antimicrobial Surface
- 16-1/2" (419 mm) rim height for accessible application
- 2-1/8" (54 mm) fully glazed trapway
- 9" x 8" (229 x 203 mm) water surface area
- 3" (76 mm) flush valve
- Five-year warranty

Nominal Dimensions:

28-1/4 in x 17-1/4 in x 30-1/4 in (717 mm x 438 mm x 768 mm)



Description	Net Wt	SKU	Color	List Price
Cadet® PRO Two-Piece 1.6 gpf/6.0 Lpf Chair Height Round Front Toilet Less Seat		215BA004.020	White	396
		215BA004.021	Bone	489
		215BA004.222	Linen	489
Cadet® PRO Two-Piece 1.6 gpf/6.0 Lpf Chair Height Round Front Right-Hand Trip Lever Toilet Less Seat		215BA005.020	White	404

Separate Components:

Cadet® PRO Chair Height Round Front Bowl	52 lb 23.9 kg	3517B101.020	White	247
		3517B101.021	Bone	307
		3517B101.222	Linen	307
Cadet® PRO 1.6 gpf/6.0 Lpf 12-Inch Rough Tank	27 lb 12.6 kg	4188A004.020	White	149
		4188A004.021	Bone	182
		4188A004.222	Linen	182
Cadet® PRO 1.6 gpf/6.0 Lpf 12-Inch Rough Right-Hand Trip Lever Tank		4188A005.020	White	157
Cadet PRO® 12-Inch Rough Toilet Tank Cover	7 lb 3.3 kg	735172-400.020	White	94
		735172-400.021	Bone	119
		735172-400.222	Linen	119
Left-Hand Trip Lever	0 lb 0.2 kg	▷7381231-200.0020A	Polished Chrome	37
		▷7381231-200.0130A	Polished Nickel	46
		▷7381231-200.0200A	White	45
		▷7381231-200.0990A	Polished Brass	45
		▷7381231-200.2240A	Oil Rubbed Bronze	67
	0 lb 0.1 kg	▷7381231-200.2780A	Legacy Bronze	108
		▷7381231-200.2950A	Brushed Nickel	54
Right-Hand Trip Lever	0 lb 0.2 kg	▷7381231-201.2950A	Brushed Nickel	54

Optional Components:

Cardiff™ Slow-Close Round Front Toilet Seat	3 lb 1.4 kg	5259B65MT.020	White	65
		5259B65MT.021	Bone	71
		5259B65MT.222	Linen	71

▷ Parts Program (Non-Premier)

Other seat options

Additional tanks

ADA when installed with provided seat, top of seat is 17" to 19" (432 to 483 mm) from the finished floor.

Meets all ANSI/ASME Low Consumption, Water Conservation Requirements

✦ Check your local codes to determine if 1.6 gpf/6.0 Lpf toilets are allowed in your area.

High Efficiency (1.28 gpf/4.8 Lpf) Toilet



Cadet® PRO Two-Piece 1.28 gpf/4.8 Lpf Chair Height Elongated 10-Inch Rough Toilet Less Seat

- Combination bowl and tank, less seat
- 10" (254 mm) rough-in
- High efficiency, ultra-low consumption (1.28 gpf/4.8 Lpf), utilizes 20% less water
- Meets EPA WaterSense® criteria
- Trade specific tank
- PowerWash® rim helps clean bowl with each flush
- Metal trip lever
- Metal shank fill valve
- Includes EZ-Install Tools
- EverClean® Antimicrobial Surface
- 16-1/2" (419 mm) rim height for accessible application
- 2-1/8" (54 mm) fully glazed trapway
- 9" x 8" (229 x 203 mm) water surface area
- 3" (76 mm) flush valve
- Five-year warranty

Nominal Dimensions:

28-1/2 in x 18 in x 30-1/4 in (723 mm x 457 mm x 768 mm)



Description	Net Wt	SKU	Color	List Price
Cadet® PRO Two-Piece 1.28 gpf/4.8 Lpf Chair Height Elongated 10-Inch Rough Toilet Less Seat		215AB104.020	White	467
		215AB104.021	Bone	669
		215AB104.222	Linen	669

Separate Components:

Cadet® PRO Chair Height Elongated Toilet Bowl Only	55 lb 25.0 kg	3517A101.020	White	264
		3517A101.021	Bone	327
		3517A101.222	Linen	327
Cadet® PRO 1.28 gpf/4.8 Lpf 10-Inch Rough Tank	27 lb 12.3 kg	4188B104.020	White	203
		4188B104.021	Bone	342
		4188B104.222	Linen	342
Cadet® PRO 10-Inch Rough Toilet Tank Cover	6 lb 2.9 kg	735173-400.020	White	107
		735173-400.021	Bone	124
		735173-400.222	Linen	124
Left-Hand Trip Lever	0 lb 0.2 kg	▷7381231-200.0020A	Polished Chrome	37
		▷7381231-200.0130A	Polished Nickel	46
		▷7381231-200.0200A	White	45
		▷7381231-200.0990A	Polished Brass	45
		▷7381231-200.2240A	Oil Rubbed Bronze	67
		▷7381231-200.2780A	Legacy Bronze	108
		▷7381231-200.2950A	Brushed Nickel	54

Optional Components:

Cardiff™ Slow-Close Elongated Toilet Seat	3 lb 1.5 kg	5257A65MT.020	White	71
		5257A65MT.021	Bone	78
		5257A65MT.222	Linen	78

▷ Parts Program (Non-Premier)

Other seat options

Additional tanks

ADA when installed with provided seat, top of seat is 17" to 19" (432 to 483 mm) from the finished floor.

Meets all ANSI/ASME Low Consumption, Water Conservation Requirements.

High Efficiency (1.28 gpf/4.8 Lpf) Toilet



Cadet® PRO Two-Piece 1.28 gpf/4.8 Lpf Chair Height Round Front 10-Inch Rough Toilet Less Seat

- Combination bowl and tank, less seat
- 10" (254 mm) rough-in
- High efficiency, ultra-low consumption (1.28 gpf/4.8 Lpf), utilizes 20% less water
- Meets EPA WaterSense® criteria
- Trade specific tank
- PowerWash® rim helps clean bowl with each flush
- Metal trip lever
- Metal shank fill valve
- Includes EZ-Install Tools
- EverClean® Antimicrobial Surface
- 16-1/2" (419 mm) rim height for accessible application
- 2-1/8" (54 mm) fully glazed trapway
- 9" x 8" (229 x 203 mm) water surface area
- 3" (76 mm) flush valve
- Five-year warranty

Nominal Dimensions:

26-1/4 in x 18 in x 30-1/4 in (666 mm x 457 mm x 768 mm)



Description	Net Wt	SKU	Color	List Price
Cadet® PRO Two-Piece 1.28 gpf/4.8 Lpf Chair Height Round Front 10-Inch Rough Toilet Less Seat		215BB104.020	White	450
		215BB104.021	Bone	649
		215BB104.222	Linen	649

Separate Components:

Cadet® PRO Chair Height Round Front Bowl	52 lb 23.9 kg	3517B101.020	White	247
		3517B101.021	Bone	307
		3517B101.222	Linen	307
Cadet® PRO 1.28 gpf/4.8 Lpf 10-Inch Rough Tank	27 lb 12.3 kg	4188B104.020	White	203
		4188B104.021	Bone	342
		4188B104.222	Linen	342
Cadet® PRO 10-Inch Rough Toilet Tank Cover	6 lb 2.9 kg	735173-400.020	White	107
		735173-400.021	Bone	124
		735173-400.222	Linen	124
Left-Hand Trip Lever	0 lb 0.2 kg	▷7381231-200.0020A	Polished Chrome	37
		▷7381231-200.0130A	Polished Nickel	46
		▷7381231-200.0200A	White	45
		▷7381231-200.0990A	Polished Brass	45
		▷7381231-200.2240A	Oil Rubbed Bronze	67
		▷7381231-200.2780A	Legacy Bronze	108
		▷7381231-200.2950A	Brushed Nickel	54

Optional Components:

Cardiff™ Slow-Close Round Front Toilet Seat	3 lb 1.4 kg	5259B65MT.020	White	65
		5259B65MT.021	Bone	71
		5259B65MT.222	Linen	71

▷ Parts Program (Non-Premier)

Other seat options

Additional tanks

ADA when installed with provided seat, top of seat is 17" to 19" (432 to 483 mm) from the finished floor.

Meets all ANSI/ASME Low Consumption, Water Conservation Requirements.

Low Consumption (1.6 gpf/6.0 Lpf) Toilet ✦



Cadet® PRO Two-Piece 1.6 gpf/6.0 Lpf Chair Height Elongated 10-Inch Rough Toilet Less Seat

- Combination bowl and tank, less seat
- 10" (254 mm) rough-in
- Low consumption (1.6 gpf/6.0 Lpf)
- Trade specific tank
- PowerWash® rim helps clean bowl with each flush
- Metal trip lever
- Metal shank fill valve
- Includes EZ-Install Tools
- EverClean® Antimicrobial Surface
- 16-1/2" (419 mm) rim height for accessible application
- 2-1/8" (54 mm) fully glazed trapway
- 9" x 8" (229 x 203 mm) water surface area
- 3" (76 mm) flush valve
- Five-year warranty

Nominal Dimensions:

28-1/2 in x 18 in x 30-1/4 in (723 mm x 457 mm x 768 mm)



Description	Net Wt	SKU	Color	List Price
Cadet® PRO Two-Piece 1.6 gpf/6.0 Lpf Chair Height Elongated 10-Inch Rough Toilet Less Seat		215AB004.020	White	467
		215AB004.021	Bone	669
		215AB004.222	Linen	669
Separate Components:				
Cadet® PRO Chair Height Elongated Toilet Bowl Only	55 lb 25.0 kg	3517A101.020	White	264
		3517A101.021	Bone	327
		3517A101.222	Linen	327
Cadet® PRO 1.6 gpf/6.0 Lpf 10-Inch Rough Tank	27 lb 12.3 kg	4188B004.020	White	203
		4188B004.021	Bone	342
		4188B004.222	Linen	342
Cadet® PRO 10-Inch Rough Toilet Tank Cover	6 lb 2.9 kg	735173-400.020	White	107
		735173-400.021	Bone	124
		735173-400.222	Linen	124
Left-Hand Trip Lever	0 lb 0.2 kg	▷7381231-200.0020A	Polished Chrome	37
		▷7381231-200.0130A	Polished Nickel	46
		▷7381231-200.0200A	White	45
		▷7381231-200.0990A	Polished Brass	45
		▷7381231-200.2240A	Oil Rubbed Bronze	67
		▷7381231-200.2780A	Legacy Bronze	108
		▷7381231-200.2950A	Brushed Nickel	54
Optional Components:				
Cardiff™ Slow-Close Elongated Toilet Seat	3 lb 1.5 kg	5257A65MT.020	White	71
		5257A65MT.021	Bone	78
		5257A65MT.222	Linen	78

▷ Parts Program (Non-Premier)

Other seat options

Additional tanks

ADA when installed with provided seat, top of seat is 17" to 19" (432 to 483 mm) from the finished floor.

Meets all ANSI/ASME Low Consumption, Water Conservation Requirements.

✦ Check your local codes to determine if 1.6 gpf/6.0 Lpf toilets are allowed in your area.

Low Consumption (1.6 gpf/6.0 Lpf) Toilet ✦



Cadet® PRO Two-Piece 1.6 gpf/6.0 Lpf Chair Height Round Front 10-Inch Rough Toilet Less Seat

- Combination bowl and tank, less seat
- 10" (254 mm) rough-in
- Low consumption (1.6 gpf/6.0 Lpf)
- Trade specific tank
- PowerWash® rim helps clean bowl with each flush
- Metal trip lever
- Metal shank fill valve
- Includes EZ-Install Tools
- EverClean® Antimicrobial Surface
- 16-1/2" (419 mm) rim height for accessible application
- 2-1/8" (54 mm) fully glazed trapway
- 9" x 8" (229 x 203 mm) water surface area
- 3" (76 mm) flush valve
- Five-year warranty

Nominal Dimensions:

26-1/4 in x 18 in x 30-1/4 in (666 mm x 457 mm x 768 mm)



Description	Net Wt	SKU	Color	List Price
Cadet® PRO Two-Piece 1.6 gpf/6.0 Lpf Chair Height Round Front 10-Inch Rough Toilet Less Seat		215BB004.020	White	450
		215BB004.021	Bone	649
		215BB004.222	Linen	649

Separate Components:

Cadet® PRO Chair Height Round Front Bowl	52 lb 23.9 kg	3517B101.020	White	247
		3517B101.021	Bone	307
		3517B101.222	Linen	307
Cadet® PRO 1.6 gpf/6.0 Lpf 10-Inch Rough Tank	27 lb 12.3 kg	4188B004.020	White	203
		4188B004.021	Bone	342
		4188B004.222	Linen	342
Cadet® PRO 10-Inch Rough Toilet Tank Cover	6 lb 2.9 kg	735173-400.020	White	107
		735173-400.021	Bone	124
		735173-400.222	Linen	124
Left-Hand Trip Lever	0 lb 0.2 kg	▷7381231-200.0020A	Polished Chrome	37
		▷7381231-200.0130A	Polished Nickel	46
		▷7381231-200.0200A	White	45
		▷7381231-200.0990A	Polished Brass	45
		▷7381231-200.2240A	Oil Rubbed Bronze	67
		▷7381231-200.2780A	Legacy Bronze	108
		▷7381231-200.2950A	Brushed Nickel	54

Optional Components:

Cardiff™ Slow-Close Round Front Toilet Seat	3 lb 1.4 kg	5259B65MT.020	White	65
		5259B65MT.021	Bone	71
		5259B65MT.222	Linen	71

▷ Parts Program (Non-Premier)

Other seat options

Additional tanks

ADA when installed with provided seat, top of seat is 17" to 19" (432 to 483 mm) from the finished floor.

Meets all ANSI/ASME Low Consumption, Water Conservation Requirements.

✦Check your local codes to determine if 1.6 gpf/6.0 Lpf toilets are allowed in your area.

High Efficiency (1.28 gpf/4.8 Lpf) Toilet



Cadet® PRO Two-Piece 1.28 gpf/4.8 Lpf Compact Chair Height Elongated Toilet Less Seat

- Combination bowl and tank, less seat
- Space saving elongated bowl fits in the space of a round front
- 12" (305 mm) rough-in
- High efficiency, ultra-low consumption (1.28 gpf/4.8 Lpf), utilizes 20% less water
- Meets EPA WaterSense® criteria
- PowerWash® rim helps clean bowl with each flush
- Trade specific tank
- Metal trip lever
- Metal shank fill valve
- Includes EZ-Install Tools
- EverClean® Antimicrobial Surface
- 16-1/2" (419 mm) rim height for accessible application
- 2-1/8" (54 mm) fully glazed trapway
- 9" x 8" (229 x 203 mm) water surface area
- 3" (76 mm) flush valve
- Five-year warranty

Nominal Dimensions:

28-1/4 in x 18 in x 30-3/8 in (717 mm x 457 mm x 771 mm)



Description	Net Wt	SKU	Color	List Price
Cadet® PRO Two-Piece 1.28 gpf/4.8 Lpf Compact Chair Height Elongated Toilet Less Seat		215FA104.020	White	481
		215FA104.021	Bone	817
		215FA104.222	Linen	817
Separate Components:				
Cadet® PRO Compact Chair Height Elongated Bowl	55 lb 25.0 kg	3517F101.020	White	278
		3517F101.021	Bone	475
		3517F101.222	Linen	475
Cadet® PRO 1.28 gpf/4.8 Lpf 10-Inch Rough Tank	27 lb 12.3 kg	4188B104.020	White	203
		4188B104.021	Bone	342
		4188B104.222	Linen	342
Cadet® PRO 10-Inch Rough Toilet Tank Cover	6 lb 2.9 kg	735173-400.020	White	107
		735173-400.021	Bone	124
		735173-400.222	Linen	124
Left-Hand Trip Lever	0 lb 0.2 kg	▷7381231-200.0020A	Polished Chrome	37
		▷7381231-200.0130A	Polished Nickel	46
		▷7381231-200.0200A	White	45
		▷7381231-200.0990A	Polished Brass	45
		▷7381231-200.2240A	Oil Rubbed Bronze	67
		▷7381231-200.2780A	Legacy Bronze	108
		▷7381231-200.2950A	Brushed Nickel	54
Optional Components:				
Cardiff™ Slow-Close Elongated Toilet Seat	3 lb 1.5 kg	5257A65MT.020	White	71
		5257A65MT.021	Bone	78
		5257A65MT.222	Linen	78

▷ Parts Program (Non-Premier)

Other seat options

Additional tanks

ADA when installed with provided seat, top of seat is 17" to 19" (432 to 483 mm) from the finished floor.

Meets all ANSI/ASME Low Consumption, Water Conservation Requirements.

High Efficiency (1.28 gpf/4.8 Lpf) Toilet



Cadet® PRO Two-Piece 1.28 gpf/4.8 Lpf Compact Chair Height Elongated 14-Inch Rough Toilet Less Seat

- Combination bowl and tank, less seat
- Space saving elongated bowl fits in the space of a round front
- 14" (356 mm) rough-in
- High efficiency, ultra-low consumption (1.28 gpf/4.8 Lpf), utilizes 20% less water
- Meets EPA WaterSense® criteria
- PowerWash® rim helps clean bowl with each flush
- Trade specific tank
- Metal trip lever
- Metal shank fill valve
- Includes EZ-Install Tools
- EverClean® Antimicrobial Surface
- 16-1/2" (419 mm) rim height for accessible application
- 2-1/8" (54 mm) fully glazed trapway
- 9" x 8" (229 x 203 mm) water surface area
- 3" (76 mm) flush valve
- Five-year warranty

Nominal Dimensions:

30 in x 17-3/8 in x 30-3/8 in (762 mm x 441 mm x 771 mm)



Description	Net Wt	SKU	Color	List Price
Cadet® PRO Two-Piece 1.28 gpf/4.8 Lpf Compact Chair Height Elongated 14-Inch Rough Toilet Less Seat		215FC104.020	White	427
		215FC104.021	Bone	657
		215FC104.222	Linen	657
Separate Components:				
Cadet® PRO Compact Chair Height Elongated Bowl	55 lb 25.0 kg	3517F101.020	White	278
		3517F101.021	Bone	475
		3517F101.222	Linen	475
Cadet® PRO 1.28 gpf/4.8 Lpf 12-Inch Rough Tank	27 lb 12.6 kg	4188A104.020	White	149
		4188A104.021	Bone	182
		4188A104.222	Linen	182
Cadet PRO® 12-Inch Rough Toilet Tank Cover	7 lb 3.3 kg	735172-400.020	White	94
		735172-400.021	Bone	119
		735172-400.222	Linen	119
Left-Hand Trip Lever	0 lb 0.2 kg	▷7381231-200.0020A	Polished Chrome	37
		▷7381231-200.0130A	Polished Nickel	46
		▷7381231-200.0200A	White	45
		▷7381231-200.0990A	Polished Brass	45
		▷7381231-200.2240A	Oil Rubbed Bronze	67
		▷7381231-200.2780A	Legacy Bronze	108
		▷7381231-200.2950A	Brushed Nickel	54
Optional Components:				
Cardiff™ Slow-Close Elongated Toilet Seat	3 lb 1.5 kg	5257A65MT.020	White	71
		5257A65MT.021	Bone	78
		5257A65MT.222	Linen	78

▷ Parts Program (Non-Premier)

Other seat options

Additional tanks

ADA when installed with provided seat, top of seat is 17" to 19" (432 to 483 mm) from the finished floor.

Meets all ANSI/ASME Low Consumption, Water Conservation Requirements.

Low Consumption (1.6 gpf/6.0 Lpf) Toilet ✦



Cadet® PRO Two-Piece 1.6 gpf/6.0 Lpf Compact Chair Height Elongated Toilet Less Seat

- Combination bowl and tank, less seat
- Space saving elongated bowl fits in the space of a round front
- 12" (305 mm) rough-in
- Low consumption (1.6 gpf/6.0 Lpf)
- Trade specific tank
- PowerWash® rim helps clean bowl with each flush
- Metal trip lever
- Metal shank fill valve
- Includes EZ-Install Tools
- EverClean® Antimicrobial Surface
- 16-1/2" (419 mm) rim height for accessible application
- 2-1/8" (54 mm) fully glazed trapway
- 9" x 8" (229 x 203 mm) water surface area
- 3" (76 mm) flush valve
- Five-year warranty

Nominal Dimensions:

28-1/4 in x 18 in x 30-3/8 in (717 mm x 457 mm x 771 mm)



Description	Net Wt	SKU	Color	List Price
Cadet® PRO Two-Piece 1.6 gpf/6.0 Lpf Compact Chair Height Elongated Toilet Less Seat		215FA004.020	White	481
		215FA004.021	Bone	817
		215FA004.222	Linen	817
Separate Components:				
Cadet® PRO Compact Chair Height Elongated Bowl	55 lb 25.0 kg	3517F101.020	White	278
		3517F101.021	Bone	475
		3517F101.222	Linen	475
Cadet® PRO 1.6 gpf/6.0 Lpf 10-Inch Rough Tank	27 lb 12.3 kg	4188B004.020	White	203
		4188B004.021	Bone	342
		4188B004.222	Linen	342
Cadet® PRO 10-Inch Rough Toilet Tank Cover	6 lb 2.9 kg	735173-400.020	White	107
		735173-400.021	Bone	124
		735173-400.222	Linen	124
Left-Hand Trip Lever	0 lb 0.2 kg	▷7381231-200.0020A	Polished Chrome	37
		▷7381231-200.0130A	Polished Nickel	46
		▷7381231-200.0200A	White	45
		▷7381231-200.0990A	Polished Brass	45
		▷7381231-200.2240A	Oil Rubbed Bronze	67
		▷7381231-200.2780A	Legacy Bronze	108
Optional Components:	3 lb 1.5 kg	5257A65MT.020	White	71
		5257A65MT.021	Bone	78
		5257A65MT.222	Linen	78

▷ Parts Program (Non-Premier)

Other seat options

Additional tanks

ADA when installed with provided seat, top of seat is 17" to 19" (432 to 483 mm) from the finished floor.

Meets all ANSI/ASME Low Consumption, Water Conservation Requirements.

✦ Check your local codes to determine if 1.6 gpf/6.0 Lpf toilets are allowed in your area.

Low Consumption (1.6 gpf/6.0 Lpf) Toilet ✦



Cadet® PRO Two-Piece 1.6 gpf/6.0 Lpf Compact Chair Height Elongated 14-Inch Rough Toilet Less Seat

- Combination bowl and tank, less seat
- Space saving elongated bowl fits in the space of a round front
- 14" (356 mm) rough-in
- Low consumption (1.6 gpf/6.0 Lpf)
- Trade specific tank
- PowerWash® rim helps clean bowl with each flush
- Metal trip lever
- Metal shank fill valve
- Includes EZ-Install Tools
- EverClean® Antimicrobial Surface
- 16-1/2" (419 mm) rim height for accessible application
- 2-1/8" (54 mm) fully glazed trapway
- 9" x 8" (229 x 203 mm) water surface area
- 3" (76 mm) flush valve
- Five-year warranty

Nominal Dimensions:

30 in x 17-3/8 in x 30-3/8 in (762 mm x 441 mm x 771 mm)



Description	Net Wt	SKU	Color	List Price
Cadet® PRO Two-Piece 1.6 gpf/6.0 Lpf Compact Chair Height Elongated 14-Inch Rough Toilet Less Seat		215FC004.020	White	427
		215FC004.021	Bone	657
		215FC004.222	Linen	657

Separate Components:

Cadet® PRO Compact Chair Height Elongated Bowl	55 lb 25.0 kg	3517F101.020	White	278
		3517F101.021	Bone	475
		3517F101.222	Linen	475
Cadet® PRO 1.6 gpf/6.0 Lpf 12-Inch Rough Tank	27 lb 12.6 kg	4188A004.020	White	149
		4188A004.021	Bone	182
		4188A004.222	Linen	182
Cadet PRO® 12-Inch Rough Toilet Tank Cover	7 lb 3.3 kg	735172-400.020	White	94
		735172-400.021	Bone	119
		735172-400.222	Linen	119
Left-Hand Trip Lever	0 lb 0.2 kg	▷7381231-200.0020A	Polished Chrome	37
		▷7381231-200.0130A	Polished Nickel	46
		▷7381231-200.0200A	White	45
		▷7381231-200.0990A	Polished Brass	45
		▷7381231-200.2240A	Oil Rubbed Bronze	67
		▷7381231-200.2780A	Legacy Bronze	108
0 lb 0.1 kg	▷7381231-200.2950A	Brushed Nickel	54	

Optional Components:

Cardiff™ Slow-Close Elongated Toilet Seat	3 lb 1.5 kg	5257A65MT.020	White	71
		5257A65MT.021	Bone	78
		5257A65MT.222	Linen	78

▷ Parts Program (Non-Premier)

Other seat options

Additional tanks

ADA when installed with provided seat, top of seat is 17" to 19" (432 to 483 mm) from the finished floor.

Meets all ANSI/ASME Low Consumption, Water Conservation Requirements.

✦ Check your local codes to determine if 1.6 gpf/6.0 Lpf toilets are allowed in your area.

High Efficiency (1.28 gpf/4.8 Lpf) Toilets



Cadet® PRO Two-Piece 1.28 gpf/4.8 Lpf Standard Height Elongated Toilet Less Seat

- Combination bowl and tank, less seat
- 12" (305 mm) rough-in
- High efficiency, ultra-low consumption (1.28 gpf/4.8 Lpf), utilizes 20% less water
- Meets EPA WaterSense® criteria
- Trade specific tank
- PowerWash® rim helps clean bowl with each flush
- Metal trip lever
- Metal shank fill valve
- Includes EZ-Install Tools
- EverClean® Antimicrobial Surface
- 2-1/8" (54 mm) fully glazed trapway
- 9" x 8" (229 x 203 mm) water surface area
- 3" (76 mm) flush valve
- Five-year warranty

Nominal Dimensions:

30-1/4 in x 17-1/4 in x 28-7/8 in (768 mm x 438 mm x 733 mm)



Description	Net Wt	SKU	Color	List Price
Cadet® PRO Two-Piece 1.28 gpf/4.8 Lpf Standard Height Elongated Toilet Less Seat		215CA104.020	White	366
		215CA104.021	Bone	451
		215CA104.222	Linen	451

Separate Components:

Cadet® PRO Standard Height Elongated Bowl	50 lb 23.1 kg	3517C101.020	White	217
		3517C101.021	Bone	269
		3517C101.222	Linen	269
Cadet® PRO 1.28 gpf/4.8 Lpf 12-Inch Rough Tank	27 lb 12.6 kg	4188A104.020	White	149
		4188A104.021	Bone	182
		4188A104.222	Linen	182
Cadet PRO® 12-Inch Rough Toilet Tank Cover	7 lb 3.3 kg	735172-400.020	White	94
		735172-400.021	Bone	119
		735172-400.222	Linen	119
Left-Hand Trip Lever	0 lb 0.2 kg	▷7381231-200.0020A	Polished Chrome	37
		▷7381231-200.0130A	Polished Nickel	46
		▷7381231-200.0200A	White	45
		▷7381231-200.0990A	Polished Brass	45
		▷7381231-200.2240A	Oil Rubbed Bronze	67
		▷7381231-200.2780A	Legacy Bronze	108
		▷7381231-200.2950A	Brushed Nickel	54

Optional Components:

Cardiff™ Slow-Close Elongated Toilet Seat	3 lb 1.5 kg	5257A65MT.020	White	71
		5257A65MT.021	Bone	78
		5257A65MT.222	Linen	78

▷ Parts Program (Non-Premier)

Other seat options

Additional tanks

Meets all ANSI/ASME Low Consumption, Water Conservation Requirements.

High Efficiency (1.28 gpf/4.8 Lpf) Toilet



Cadet® PRO Two-Piece 1.28 gpf/4.8 Lpf Standard Height Round Front Toilet Less Seat

- Combination bowl and tank, less seat
- 12" (305 mm) rough-in
- High efficiency, ultra-low consumption (1.28 gpf/4.8 Lpf), utilizes 20% less water
- Meets EPA WaterSense® criteria
- Trade specific tank
- PowerWash® rim helps clean bowl with each flush
- Metal trip lever
- Metal shank fill valve
- Includes EZ-Install Tools
- EverClean® Antimicrobial Surface
- 2-1/8" (54 mm) fully glazed trapway
- 9" x 8" (229 x 203 mm) water surface area
- 3" (76 mm) flush valve
- Five-year warranty

Nominal Dimensions:

28-1/4 in x 17-1/4 in x 28-7/8 in (717 mm x 438 mm x 733 mm)



Description	Net Wt	SKU	Color	List Price
Cadet® PRO Two-Piece 1.28 gpf/4.8 Lpf Standard Height Round Front Toilet Less Seat		215DA104.020	White	325
		215DA104.021	Bone	401
		215DA104.222	Linen	401

Separate Components:

Cadet® PRO Standard Height Round Front Bowl	46 lb 21.3 kg	3517D101.020	White	176
		3517D101.021	Bone	219
		3517D101.222	Linen	219
Cadet® PRO 1.28 gpf/4.8 Lpf 12-Inch Rough Tank	27 lb 12.6 kg	4188A104.020	White	149
		4188A104.021	Bone	182
		4188A104.222	Linen	182
Cadet PRO® 12-Inch Rough Toilet Tank Cover	7 lb 3.3 kg	735172-400.020	White	94
		735172-400.021	Bone	119
		735172-400.222	Linen	119
Left-Hand Trip Lever	0 lb 0.2 kg	▷7381231-200.0020A	Polished Chrome	37
		▷7381231-200.0130A	Polished Nickel	46
		▷7381231-200.0200A	White	45
		▷7381231-200.0990A	Polished Brass	45
		▷7381231-200.2240A	Oil Rubbed Bronze	67
		▷7381231-200.2780A	Legacy Bronze	108
		▷7381231-200.2950A	Brushed Nickel	54

Optional Components:

Cardiff™ Slow-Close Round Front Toilet Seat	3 lb 1.4 kg	5259B65MT.020	White	65
		5259B65MT.021	Bone	71
		5259B65MT.222	Linen	71

▷ Parts Program (Non-Premier)

Other seat options

Additional tanks

Meets all ANSI/ASME Low Consumption, Water Conservation Requirements.

Low Consumption (1.6 gpf/6.0 Lpf) Toilet ✦



Cadet® PRO Two-Piece 1.6 gpf/6.0 Lpf Standard Height Elongated Toilet Less Seat

- Combination bowl and tank, less seat
- 12" (305 mm) rough-in
- Low consumption (1.6 gpf/6.0 Lpf)
- Trade specific tank
- PowerWash® rim helps clean bowl with each flush
- Metal trip lever
- Metal shank fill valve
- Includes EZ-Install Tools
- EverClean® Antimicrobial Surface
- 2-1/8" (54 mm) fully glazed trapway
- 9" x 8" (229 x 203 mm) water surface area
- 3" (76 mm) flush valve
- Five-year warranty

Nominal Dimensions:

30-1/4 in x 17-1/4 in x 28-7/8 in (768 mm x 438 mm x 733 mm)

Description	Net Wt	SKU	Color	List Price
Cadet® PRO Two-Piece 1.6 gpf/6.0 Lpf Standard Height Elongated Toilet Less Seat		215CA004.020	White	366
		215CA004.021	Bone	451
		215CA004.222	Linen	451

Separate Components:

Cadet® PRO Standard Height Elongated Bowl	50 lb 23.1 kg	3517C101.020	White	217
		3517C101.021	Bone	269
		3517C101.222	Linen	269
Cadet® PRO 1.6 gpf/6.0 Lpf 12-Inch Rough Tank	27 lb 12.6 kg	4188A004.020	White	149
		4188A004.021	Bone	182
		4188A004.222	Linen	182
Cadet PRO® 12-Inch Rough Toilet Tank Cover	7 lb 3.3 kg	735172-400.020	White	94
		735172-400.021	Bone	119
		735172-400.222	Linen	119
Left-Hand Trip Lever	0 lb 0.2 kg	▷7381231-200.0020A	Polished Chrome	37
		▷7381231-200.0130A	Polished Nickel	46
		▷7381231-200.0200A	White	45
		▷7381231-200.0990A	Polished Brass	45
		▷7381231-200.2240A	Oil Rubbed Bronze	67
		▷7381231-200.2780A	Legacy Bronze	108
		▷7381231-200.2950A	Brushed Nickel	54

Optional Components:

Cardiff™ Slow-Close Elongated Toilet Seat	3 lb 1.5 kg	5257A65MT.020	White	71
		5257A65MT.021	Bone	78
		5257A65MT.222	Linen	78

▷ Parts Program (Non-Premier)

Other seat options

Additional tanks

Meets all ANSI/ASME Low Consumption, Water Conservation Requirements.

✦ Check your local codes to determine if 1.6 gpf/6.0 Lpf toilets are allowed in your area.

Low Consumption (1.6 gpf/6.0 Lpf) Toilet ✦



Cadet® PRO Two-Piece 1.6 gpf/6.0 Lpf Standard Height Round Front Toilet Less Seat

- Combination bowl and tank, less seat
- 12" (305 mm) rough-in
- Low consumption (1.6 gpf/6.0 Lpf)
- Trade specific tank
- PowerWash® rim helps clean bowl with each flush
- Metal trip lever
- Metal shank fill valve
- Includes EZ-Install Tools
- EverClean® Antimicrobial Surface
- 2-1/8" (54 mm) fully glazed trapway
- 9" x 8" (229 x 203 mm) water surface area
- 3" (76 mm) flush valve
- Five-year warranty
- Round Front Toilet Less Seat

Nominal Dimensions:

28-1/4 in x 17-1/4 in x 28-7/8 in (717 mm x 438 mm x 733 mm)

Description	Net Wt	SKU	Color	List Price
Cadet® PRO Two-Piece 1.6 gpf/6.0 Lpf Standard Height Round Front Toilet Less Seat		215DA004.020	White	325
		215DA004.021	Bone	401
		215DA004.222	Linen	401

Separate Components:

Cadet® PRO Standard Height Round Front Bowl	46 lb 21.3 kg	3517D101.020	White	176
		3517D101.021	Bone	219
		3517D101.222	Linen	219
Cadet® PRO 1.6 gpf/6.0 Lpf 12-Inch Rough Tank	27 lb 12.6 kg	4188A004.020	White	149
		4188A004.021	Bone	182
		4188A004.222	Linen	182
Cadet PRO® 12-Inch Rough Toilet Tank Cover	7 lb 3.3 kg	735172-400.020	White	94
		735172-400.021	Bone	119
		735172-400.222	Linen	119
Left-Hand Trip Lever	0 lb 0.2 kg	▷7381231-200.0020A	Polished Chrome	37
		▷7381231-200.0130A	Polished Nickel	46
		▷7381231-200.0200A	White	45
		▷7381231-200.0990A	Polished Brass	45
		▷7381231-200.2240A	Oil Rubbed Bronze	67
		▷7381231-200.2780A	Legacy Bronze	108
		▷7381231-200.2950A	Brushed Nickel	54

Optional Components:

Cardiff™ Slow-Close Round Front Toilet Seat	3 lb 1.4 kg	5259B65MT.020	White	65
		5259B65MT.021	Bone	71
		5259B65MT.222	Linen	71

▷ Parts Program (Non-Premier)

Other seat options

Additional tanks

Meets all ANSI/ASME Low Consumption, Water Conservation Requirements.

✦ Check your local codes to determine if 1.6 gpf/6.0 Lpf toilets are allowed in your area.

High Efficiency (1.28 gpf/4.8 Lpf) Toilets



Cadet® PRO Two-Piece 1.28 gpf/4.8 Lpf Standard Height Elongated 10-Inch Rough Toilet Less Seat

- Combination bowl and tank, less seat
- 10" (254 mm) rough-in
- High efficiency, ultra-low consumption (1.28 gpf/4.8 Lpf), utilizes 20% less water
- Meets EPA WaterSense® criteria
- Trade specific tank
- PowerWash® rim helps clean bowl with each flush
- Metal trip lever
- Metal shank fill valve
- Includes EZ-Install Tools
- EverClean® Antimicrobial Surface
- 2-1/8" (54 mm) fully glazed trapway
- 9" x 8" (229 x 203 mm) water surface area
- 3" (76 mm) flush valve
- Five-year warranty

Nominal Dimensions:

28-1/2 in x 18 in x 29 in (723 mm x 457 mm x 736 mm)



Description	Net Wt	SKU	Color	List Price
Cadet® PRO Two-Piece 1.28 gpf/4.8 Lpf Standard Height Elongated 10-Inch Rough Toilet Less Seat		215CB104.020	White	420
		215CB104.021	Bone	611
		215CB104.222	Linen	611

Separate Components:

Cadet® PRO Standard Height Elongated Bowl	50 lb 23.1 kg	3517C101.020	White	217
		3517C101.021	Bone	269
		3517C101.222	Linen	269
Cadet® PRO 1.28 gpf/4.8 Lpf 10-Inch Rough Tank	27 lb 12.3 kg	4188B104.020	White	203
		4188B104.021	Bone	342
		4188B104.222	Linen	342
Cadet® PRO 10-Inch Rough Toilet Tank Cover	6 lb 2.9 kg	735173-400.020	White	107
		735173-400.021	Bone	124
		735173-400.222	Linen	124
Left-Hand Trip Lever	0 lb 0.2 kg	▷7381231-200.0020A	Polished Chrome	37
		▷7381231-200.0130A	Polished Nickel	46
		▷7381231-200.0200A	White	45
		▷7381231-200.2240A	Oil Rubbed Bronze	67
		▷7381231-200.2780A	Legacy Bronze	108
		▷7381231-200.2950A	Brushed Nickel	54

Optional Components:

Cardiff™ Slow-Close Elongated Toilet Seat	3 lb 1.5 kg	5257A65MT.020	White	71
		5257A65MT.021	Bone	78
		5257A65MT.222	Linen	78

▷ Parts Program (Non-Premier)

Other seat options

Additional tanks

Meets all ANSI/ASME Low Consumption, Water Conservation Requirements.

High Efficiency (1.28 gpf/4.8 Lpf) Toilet



Cadet® PRO Two-Piece 1.28 gpf/4.8 Lpf Standard Height Round Front 10-Inch Rough Toilet Less Seat

- Combination bowl and tank, less seat
- 10" (254 mm) rough-in
- High efficiency, ultra-low consumption (1.28 gpf/4.8 Lpf), utilizes 20% less water
- Meets EPA WaterSense® criteria
- Trade specific tank
- PowerWash® rim helps clean bowl with each flush
- Metal trip lever
- Metal shank fill valve
- Includes EZ-Install Tools
- EverClean® Antimicrobial Surface
- 2-1/8" (54 mm) fully glazed trapway
- 9" x 8" (229 x 203 mm) water surface area
- 3" (76 mm) flush valve
- Five-year warranty
- Round Front Toilet Less Seat

Nominal Dimensions:

26-1/4 in x 18 in x 29 in (666 mm x 457 mm x 736 mm)



Description	Net Wt	SKU	Color	List Price
Cadet® PRO Two-Piece 1.28 gpf/4.8 Lpf Standard Height Round Front 10-Inch Rough Toilet Less Seat		215DB104.020	White	379
		215DB104.021	Bone	561
		215DB104.222	Linen	561

Separate Components:

Cadet® PRO Standard Height Round Front Bowl	46 lb 21.3 kg	3517D101.020	White	176
		3517D101.021	Bone	219
		3517D101.222	Linen	219
Cadet® PRO 1.28 gpf/4.8 Lpf 10-Inch Rough Tank	27 lb 12.3 kg	4188B104.020	White	203
		4188B104.021	Bone	342
		4188B104.222	Linen	342
Cadet® PRO 10-Inch Rough Toilet Tank Cover	6 lb 2.9 kg	735173-400.020	White	107
		735173-400.021	Bone	124
		735173-400.222	Linen	124
Left-Hand Trip Lever	0 lb 0.2 kg	▷7381231-200.0020A	Polished Chrome	37
		▷7381231-200.0130A	Polished Nickel	46
		▷7381231-200.0200A	White	45
		▷7381231-200.0990A	Polished Brass	45
		▷7381231-200.2240A	Oil Rubbed Bronze	67
		▷7381231-200.2780A	Legacy Bronze	108
		▷7381231-200.2950A	Brushed Nickel	54

Optional Components:

Cardiff™ Slow-Close Round Front Toilet Seat	3 lb 1.4 kg	5259B65MT.020	White	65
		5259B65MT.021	Bone	71
		5259B65MT.222	Linen	71

▷ Parts Program (Non-Premier)

Other seat options

Additional tanks

Meets all ANSI/ASME Low Consumption, Water Conservation Requirements.

Low Consumption (1.6 gpf/6.0 Lpf) Toilets ✦



Cadet® PRO Two-Piece 1.6 gpf/6.0 Lpf Standard Height Elongated 10-Inch Rough Toilet Less Seat

- Combination bowl and tank, less seat
- 10" (254 mm) rough-in
- Low consumption (1.6 gpf/6.0 Lpf)
- Trade specific tank
- PowerWash® rim helps clean bowl with each flush
- Metal trip lever
- Metal shank fill valve
- Includes EZ-Install Tools
- EverClean® Antimicrobial Surface
- 2-1/8" (54 mm) fully glazed trapway
- 9" x 8" (229 x 203 mm) water surface area
- 3" (76 mm) flush valve
- Five-year warranty

Nominal Dimensions:

28-1/2 in x 18 in x 29 in (723 mm x 457 mm x 736 mm)

Description	Net Wt	SKU	Color	List Price
Cadet® PRO Two-Piece 1.6 gpf/6.0 Lpf Standard Height Elongated 10-Inch Rough Toilet Less Seat		215CB004.020	White	420
		215CB004.021	Bone	611
		215CB004.222	Linen	611
Separate Components:				
Cadet® PRO Standard Height Elongated Bowl	50 lb 23.1 kg	3517C101.020	White	217
		3517C101.021	Bone	269
		3517C101.222	Linen	269
Cadet® PRO 1.6 gpf/6.0 Lpf 10-Inch Rough Tank	27 lb 12.3 kg	4188B004.020	White	203
		4188B004.021	Bone	342
		4188B004.222	Linen	342
Cadet® PRO 10-Inch Rough Toilet Tank Cover	6 lb 2.9 kg	735173-400.020	White	107
		735173-400.021	Bone	124
		735173-400.222	Linen	124
Left-Hand Trip Lever	0 lb 0.2 kg	▷7381231-200.0020A	Polished Chrome	37
		▷7381231-200.0130A	Polished Nickel	46
		▷7381231-200.0200A	White	45
			Polished Brass	45
			Oil Rubbed Bronze	67
		▷7381231-200.2780A	Legacy Bronze	108
		▷7381231-200.2950A	Brushed Nickel	54
Optional Components:				
Cardiff™ Slow-Close Elongated Toilet Seat	3 lb 1.5 kg	5257A65MT.020	White	71
		5257A65MT.021	Bone	78
		5257A65MT.222	Linen	78

▷ Parts Program (Non-Premier)

Other seat options

Additional tanks

Meets all ANSI/ASME Low Consumption, Water Conservation Requirements.

✦Check your local codes to determine if 1.6 gpf/6.0 Lpf toilets are allowed in your area.

Low Consumption (1.6 gpf/6.0 Lpf) Toilet ✦



Cadet® PRO Two-Piece 1.6 gpf/6.0 Lpf Standard Height Round Front 10-Inch Rough Toilet Less Seat

- Combination bowl and tank, less seat
- 10" (254 mm) rough-in
- Low consumption (1.6 gpf/6.0 Lpf)
- Trade specific tank
- PowerWash® rim helps clean bowl with each flush
- Metal trip lever
- Metal shank fill valve
- Includes EZ-Install Tools
- EverClean® Antimicrobial Surface
- 2-1/8" (54 mm) fully glazed trapway
- 9" x 8" (229 x 203 mm) water surface area
- 3" (76 mm) flush valve
- Five-year warranty
- Round Front Toilet Less Seat

Nominal Dimensions:

26-1/4 in x 18 in x 29 in (666 mm x 457 mm x 736 mm)

Description	Net Wt	SKU	Color	List Price
Cadet® PRO Two-Piece 1.6 gpf/6.0 Lpf Standard Height Round Front 10-Inch Rough Toilet Less Seat		215DB004.020	White	379
		215DB004.021	Bone	561
		215DB004.222	Linen	561

Separate Components:

Cadet® PRO Standard Height Round Front Bowl	46 lb 21.3 kg	3517D101.020	White	176
		3517D101.021	Bone	219
		3517D101.222	Linen	219
Cadet® PRO 1.6 gpf/6.0 Lpf 10-Inch Rough Tank	27 lb 12.3 kg	4188B004.020	White	203
		4188B004.021	Bone	342
		4188B004.222	Linen	342
Cadet® PRO 10-Inch Rough Toilet Tank Cover	6 lb 2.9 kg	735173-400.020	White	107
		735173-400.021	Bone	124
		735173-400.222	Linen	124
Left-Hand Trip Lever	0 lb 0.2 kg	▷7381231-200.0020A	Polished Chrome	37
	0 lb 0.1 kg	▷7381231-200.0130A	Polished Nickel	46
	0 lb 0.2 kg	▷7381231-200.0200A	White	45
		▷7381231-200.0990A	Polished Brass	45
		▷7381231-200.2240A	Oil Rubbed Bronze	67
	0 lb 0.1 kg	▷7381231-200.2780A	Legacy Bronze	108
	0 lb 0.0 kg	▷7381231-200.2950A	Brushed Nickel	54

Optional Components:

Cardiff™ Slow-Close Round Front Toilet Seat	3 lb 1.4 kg	5259B65MT.020	White	65
		5259B65MT.021	Bone	71
		5259B65MT.222	Linen	71

▷ Parts Program (Non-Premier)

Other seat options

Additional tanks

Meets all ANSI/ASME Low Consumption, Water Conservation Requirements.

✦ Check your local codes to determine if 1.6 gpf/6.0 Lpf toilets are allowed in your area.

High Efficiency (1.28 gpf/4.8 Lpf) Toilet



Cadet® Ovation Two-Piece 1.28 gpf/4.8 Lpf Chair Height Elongated Toilet With Seat

- Toilet-To-Go (TTG) shipped in single carton
- 12" (305 mm) rough-in
- High efficiency, ultra-low consumption (1.28 gpf/4.8 Lpf), utilizes 20% less water
- Meets EPA WaterSense® criteria
- PowerWash® rim helps clean bowl with each flush
- Chrome trip lever
- Includes EZ-Install Tools
- EverClean® Antimicrobial Surface
- 16-1/2" (419 mm) rim height for accessible application
- 2-1/8" (54 mm) fully glazed trapway
- 9" x 8" (229 x 203 mm) water surface area
- 3" (76 mm) flush valve
- Includes wax ring and color-matched slow-close toilet seat and cover
- Limited Lifetime warranty on Chinaware, 5 year warranty on mechanical parts, 1 year warranty on seat

Nominal Dimensions:

30-3/4 in x 16-3/16 in x 30-3/16 in (781 mm x 411 mm x 766 mm)



Description	Net Wt	SKU	Color	List Price
Cadet® Ovation Two-Piece 1.28 gpf/4.8 Lpf Chair Height Elongated Toilet With Seat	85 lb 39.0 kg	760AA101.020	White	

Separate Components:

Cadet Ovation 12-Inch Rough Tank	27 lb 12.4 kg	4299A101R.020	White	
Transitional Slow-Close Elongated Toilet Seat	2 lb 1.3 kg	5503A00B.020	White	57
Left-Hand Trip Lever	0 lb 0.1 kg	▶7381919-200.0020A	Polished Chrome	9

▷ Parts Program (Non-Premier)

ADA when installed with provided seat, top of seat is 17" to 19" (432 to 483 mm) from the finished floor.

Meets all ANSI/ASME Low Consumption, Water Conservation Requirements.

High Efficiency (1.28 gpf/4.8 Lpf) Toilets



Champion PRO Two-Piece 1.28 gpf/4.8 Lpf Chair Height Elongated Toilet Less Seat

- Combination bowl and tank, less seat
- High efficiency, ultra-low consumption (1.28 gpf/4.8 Lpf), utilizes 20% less water
- Meets EPA WaterSense® criteria
- Trade specific tank
- PowerWash® rim helps clean bowl with each flush
- Metal trip lever
- Metal shank fill valve
- Includes EZ-Install Tools
- EverClean® Antimicrobial Surface
- 4" (102 mm) piston-action Accelerator™ flush valve
- 2-3/8" (60 mm) fully-glazed trapway
- 16-1/2" (419 mm) rim height for accessible applications
- 12" (305 mm) rough-in
- 10-year warranty

Nominal Dimensions:

30-1/4 in x 19 in x 31 in (768 mm x 482 mm x 787 mm)



Description	Net Wt	SKU	Color	List Price
Champion PRO Two-Piece 1.28 gpf/4.8 Lpf Chair Height Elongated Toilet Less Seat		211AA104.020	White	533
		211AA104.021	Bone	670
		211AA104.222	Linen	670
Champion PRO Two-Piece 1.28 gpf/4.8 Lpf Chair Height Elongated Right-Hand Trip Lever Toilet Less Seat		211AA105.020	White	563

Separate Components:

Champion® PRO Chair Height Elongated Bowl	57 lb 25.9 kg	3195A101.020	White	303
		3195A101.021	Bone	378
		3195A101.222	Linen	378
Champion® PRO 1.28 gpf/4.8 Lpf 12-Inch Rough Tank	31 lb 14.1 kg	4225A104.020	White	230
		4225A104.021	Bone	292
		4225A104.222	Linen	292
Champion® PRO 1.28 gpf/4.8 Lpf 12-Inch Rough Right Hand Trip Lever Tank		4225A105.020	White	260
Champion® PRO 12-Inch Rough Toilet Tank Cover	8 lb 3.7 kg	735171-400.020	White	98
		735171-400.021	Bone	124
		735171-400.222	Linen	124
Left-Hand Trip Lever	0 lb 0.2 kg	▷7381232-200.0020A	Polished Chrome	42
		▷7381232-200.0130A	Polished Nickel	46
		▷7381232-200.0200A	White	52
		▷7381232-200.2240A	Oil Rubbed Bronze	103
		▷7381232-200.2780A	Legacy Bronze	78
Right-Hand Trip Lever	0 lb 0.2 kg	▷7381232-200.2950A	Brushed Nickel	55
		▷7381232-201.2950A	Brushed Nickel	55

▷ Parts Program (Non-Premier)

Other seat options

Additional tanks

ADA when installed with provided seat, top of seat is 17" to 19" (432 to 483 mm) from the finished floor.

Meets all ANSI/ASME Low Consumption, Water Conservation Requirements.

Optional Components:

Champion® Slow-Close & Easy Lift-Off Elongated Toilet Seat	3 lb 1.6 kg	5321A65CT.020	White	98
		5321A65CT.021	Bone	123
		5321A65CT.222	Linen	123

High Efficiency (1.28 gpf/4.8 Lpf) Toilets



Champion® PRO Two-Piece 1.28 gpf/4.8 Lpf Chair Height Round Front Toilet Less Seat

- Combination bowl and tank, less seat
- High efficiency, ultra-low consumption (1.28 gpf/4.8 Lpf), utilizes 20% less water
- Meets EPA WaterSense® criteria
- Trade specific tank
- PowerWash® rim helps clean bowl with each flush
- Metal trip lever
- Metal shank fill valve
- Includes EZ-Install Tools
- EverClean® Antimicrobial Surface
- 4" (102 mm) piston-action Accelerator™ flush valve
- 2-3/8" (60 mm) fully-glazed trapway
- 16-1/2" (419 mm) rim height for accessible applications
- 12" (305 mm) rough-in
- 10-year warranty

Nominal Dimensions:

28-1/4 in x 19 in x 31 in (717 mm x 482 mm x 787 mm)



Description	Net Wt	SKU	Color	List Price
Champion® PRO Two-Piece 1.28 gpf/4.8 Lpf Chair Height Round Front Toilet Less Seat		211BA104.020	White	477
		211BA104.021	Bone	598
		211BA104.222	Linen	598
Champion® PRO Two-Piece 1.28 gpf/4.8 Lpf Chair Height Round Front Right-Hand Trip Lever Toilet Less Seat		211BA105.020	White	507

Separate Components:

Champion® PRO Chair Height Round Front Bowl	57 lb 25.9 kg	3195B101.020	White	247
		3195B101.021	Bone	306
		3195B101.222	Linen	306
Champion® PRO 1.28 gpf/4.8 Lpf 12-Inch Rough Tank	31 lb 14.1 kg	4225A104.020	White	230
		4225A104.021	Bone	292
		4225A104.222	Linen	292
Champion® PRO 1.28 gpf/4.8 Lpf 12-Inch Rough Right Hand Trip Lever Tank		4225A105.020	White	260
Champion® PRO 12-Inch Rough Toilet Tank Cover	8 lb 3.7 kg	735171-400.020	White	98
		735171-400.021	Bone	124
		735171-400.222	Linen	124
Left-Hand Trip Lever	0 lb 0.2 kg	▷7381232-200.0020A	Polished Chrome	42
		▷7381232-200.0130A	Polished Nickel	46
	0 lb 0.2 kg	▷7381232-200.0200A	White	52
		▷7381232-200.2240A	Oil Rubbed Bronze	103
	0 lb 0.1 kg	▷7381232-200.2780A	Legacy Bronze	78
		▷7381232-200.2950A	Brushed Nickel	55
Right-Hand Trip Lever	0 lb 0.2 kg	▷7381232-201.2950A	Brushed Nickel	55

▷ Parts Program (Non-Premier)

Other seat options

Additional tanks

ADA when installed with provided seat, top of seat is 17" to 19" (432 to 483 mm) from the finished floor.

Meets all ANSI/ASME Low Consumption, Water Conservation Requirements.

Optional Components:

Champion® Slow-Close & Easy Lift-Off Round Front Toilet Seat	3 lb 1.4 kg	5320B65CT.020	White	83
		5320B65CT.021	Bone	110
		5320B65CT.222	Linen	110

Low Consumption (1.6 gpf/6.0 Lpf) Toilets ✦



Champion® PRO Two-Piece 1.6 gpf/6.0 Lpf Chair Height Elongated Toilet Less Seat

- Combination bowl and tank, less seat
- Low consumption (1.6 gpf/6.0 Lpf)
- Trade specific tank
- PowerWash® rim helps clean bowl with each flush
- Metal trip lever and metal shank fill valve
- Includes EZ-Install Tools
- EverClean® Antimicrobial Surface
- 4" (102 mm) piston-action Accelerator™ flush valve
- 2-3/8" (60 mm) fully-glazed trapway
- 16-1/2" (419 mm) rim height for accessible applications
- 12" (305 mm) rough-in
- 10-year warranty

Nominal Dimensions:

29-3/16 in x 19 in x 30-7/8 in (741 mm x 482 mm x 784 mm)



Description	Net Wt	SKU	Color	List Price
Champion® PRO Two-Piece 1.6 gpf/6.0 Lpf Chair Height Elongated Toilet Less Seat		211AA004.020	White	533
		211AA004.021	Bone	670
		211AA004.222	Linen	670
Champion® PRO Two-Piece 1.6 gpf/6.0 Lpf Chair Height Elongated Right-Hand Trip Lever Toilet Less Seat		211AA005.020	White	563

Separate Components:

Champion® PRO Chair Height Elongated Bowl	57 lb 25.9 kg	3195A101.020	White	303
		3195A101.021	Bone	378
		3195A101.222	Linen	378
Champion® PRO 1.6 gpf/6.0 Lpf 12-Inch Rough Tank	31 lb 14.1 kg	4225A004.020	White	230
		4225A004.021	Bone	292
		4225A004.222	Linen	292
Champion® PRO 1.6 gpf/6.0 Lpf 12-Inch Rough Right-Hand Trip Lever Tank		4225A005.020	White	260
Champion® PRO 12-Inch Rough Toilet Tank Cover	8 lb 3.7 kg	735171-400.020	White	98
		735171-400.021	Bone	124
		735171-400.222	Linen	124
Left-Hand Trip Lever	0 lb 0.2 kg	▷7381232-200.0020A	Polished Chrome	42
		▷7381232-200.0130A	Polished Nickel	46
		▷7381232-200.0200A	White	52
		▷7381232-200.2240A	Oil Rubbed Bronze	103
		▷7381232-200.2780A	Legacy Bronze	78
		▷7381232-200.2950A	Brushed Nickel	55
Right-Hand Trip Lever	0.2 kg	▷7381232-201.2950A	Brushed Nickel	55

Optional Components:

Champion® Slow-Close & Easy Lift-Off Elongated Toilet Seat	3 lb 1.6 kg	5321A65CT.020	White	98
		5321A65CT.021	Bone	123
		5321A65CT.222	Linen	123

▷ Parts Program (Non-Premier)

Other seat options

Additional tanks

ADA when installed with provided seat, top of seat is 17" to 19" (432 to 483 mm) from the finished floor.

Meets all ANSI/ASME Low Consumption, Water Conservation Requirements.

✦ Check your local codes to determine if 1.6 gpf/6.0 Lpf toilets are allowed in your area.

Low Consumption (1.6 gpf/6.0 Lpf) Toilets ✦



Champion® PRO Two-Piece 1.6 gpf/6.0 Lpf Chair Height Round Front Toilet Less Seat

- Combination bowl and tank, less seat
- Low consumption (1.6 gpf/6.0 Lpf)
- Trade specific tank
- PowerWash® rim helps clean bowl with each flush
- Metal trip lever
- Metal shank fill valve
- Includes EZ-Install Tools
- EverClean® Antimicrobial Surface
- 4" (102 mm) piston-action Accelerator™ flush valve
- 2-3/8" (60 mm) fully-glazed trapway
- 12" (305 mm) rough-in
- 10-year warranty

Nominal Dimensions:

28-1/4 in x 19 in x 31 in (717 mm x 482 mm x 787 mm)



Description	Net Wt	SKU	Color	List Price
Champion® PRO Two-Piece 1.6 gpf/6.0 Lpf Chair Height Round Front Toilet Less Seat		211BA004.020	White	477
		211BA004.021	Bone	598
		211BA004.222	Linen	598
Champion PRO Two-Piece 1.6 gpf/6.0 Lpf Chair Height Round Front Right-Hand Trip Lever Toilet Less Seat		211BA005.020	White	507

Separate Components:

Champion® PRO Chair Height Round Front Bowl	57 lb 25.9 kg	3195B101.020	White	247
		3195B101.021	Bone	306
		3195B101.222	Linen	306
Champion® PRO 1.6 gpf/6.0 Lpf 12-Inch Rough Tank	31 lb 14.1 kg	4225A004.020	White	230
		4225A004.021	Bone	292
		4225A004.222	Linen	292
Champion® PRO 1.6 gpf/6.0 Lpf 12-Inch Rough Right-Hand Trip Lever Tank		4225A005.020	White	260
Champion® PRO 12-Inch Rough Toilet Tank Cover	8 lb 3.7 kg	735171-400.020	White	98
		735171-400.021	Bone	124
		735171-400.222	Linen	124
Left-Hand Trip Lever	0 lb 0.2 kg	▷7381232-200.0020A	Polished Chrome	42
		▷7381232-200.0130A	Polished Nickel	46
		▷7381232-200.0200A	White	52
		▷7381232-200.2240A	Oil Rubbed Bronze	103
		▷7381232-200.2780A	Legacy Bronze	78
		▷7381232-200.2950A	Brushed Nickel	55
Right-Hand Trip Lever	0.2 kg	▷7381232-201.2950A	Brushed Nickel	55

Optional Components:

Champion® Slow-Close & Easy Lift-Off Round Front Toilet Seat	3 lb 1.4 kg	5320B65CT.020	White	83
		5320B65CT.021	Bone	110
		5320B65CT.222	Linen	110

▷ Parts Program (Non-Premier)

Other seat options

Additional tanks

ADA when installed with provided seat, top of seat is 17" to 19" (432 to 483 mm) from the finished floor.

Meets all ANSI/ASME Low Consumption, Water Conservation Requirements.

✦ Check your local codes to determine if 1.6 gpf/6.0 Lpf toilets are allowed in your area.

High Efficiency (1.28 gpf/4.8 Lpf) Toilets



Champion® PRO Two-Piece 1.28 gpf/4.8 Lpf Standard Height Elongated Toilet Less Seat

- Combination bowl and tank, less seat
- High efficiency, ultra-low consumption (1.28 gpf/4.8 Lpf), utilizes 20% less water
- Meets EPA WaterSense® criteria
- Trade specific tank
- PowerWash® rim helps clean bowl with each flush
- Metal trip lever
- Metal shank fill valve
- Includes EZ-Install Tools
- EverClean® Antimicrobial Surface
- 4" (102 mm) piston-action Accelerator™ flush valve
- 2-3/8" (60 mm) fully-glazed trapway
- 12" (305 mm) rough-in
- 10-year warranty

Nominal Dimensions:

30-1/4 in x 19 in x 29-3/8 in (768 mm x 482 mm x 746 mm)



Description	Net Wt	SKU	Color	List Price
Champion® PRO Two-Piece 1.28 gpf/4.8 Lpf Standard Height Elongated Toilet Less Seat		211CA104.020	White	490
Champion® PRO Two-Piece 1.28 gpf/4.8 Lpf Standard Height Right-Hand Trip Lever Elongated Toilet Less Seat		211CA105.020	White	520
Separate Components:				
Champion® PRO Standard Height Elongated Bowl	55 lb 25.1 kg	3195C101.020	White	260
Champion® PRO 1.28 gpf/4.8 Lpf 12-Inch Rough Tank	31 lb 14.1 kg	4225A104.020	White	230
Champion® PRO 1.28 gpf/4.8 Lpf 12-Inch Rough Right Hand Trip Lever Tank	31 lb 14.3 kg	4225A105.020	White	260
Champion® PRO 12-Inch Rough Toilet Tank Cover	8 lb 3.7 kg	735171-400.020	White	98
Left-Hand Trip Lever	0 lb 0.2 kg	▷7381232-200.0020A	Polished Chrome	42
	0 lb 0.1 kg	▷7381232-200.0130A	Polished Nickel	46
	0 lb 0.2 kg	▷7381232-200.0200A	White	52
		▷7381232-200.2240A	Oil Rubbed Bronze	103
	0 lb 0.1 kg	▷7381232-200.2780A	Legacy Bronze	78
Right-Hand Trip Lever	0 lb 0.2 kg	▷7381232-200.2950A	Brushed Nickel	55
		▷7381232-201.2950A	Brushed Nickel	55
Optional Components:				
Champion® Slow-Close & Easy Lift-Off Elongated Toilet Seat	3 lb 1.6 kg	5321A65CT.020	White	98

▷ Parts Program (Non-Premier)

Other seat options

Additional tanks

Meets all ANSI/ASME Low Consumption, Water Conservation Requirements.

Low Consumption (1.6 gpf/6.0 Lpf) Toilets ✦



Champion® PRO Two-Piece 1.6 gpf/6.0 Lpf Standard Height Elongated Toilet Less Seat

- Combination bowl and tank, less seat
- Low consumption (1.6 gpf/6.0 Lpf)
- Trade specific tank
- PowerWash® rim helps clean bowl with each flush
- Metal trip lever
- Metal shank fill valve
- Includes EZ-Install Tools
- EverClean® Antimicrobial Surface
- 4" (102 mm) piston-action Accelerator™ flush valve
- 2-3/8" (60 mm) fully-glazed trapway
- 12" (305 mm) rough-in
- 10-year warranty

Nominal Dimensions:

30-1/4 in x 19 in x 29-3/8 in (768 mm x 482 mm x 746 mm)

Description	Net Wt	SKU	Color	List Price
Champion® PRO Two-Piece 1.6 gpf/6.0 Lpf Standard Height Elongated Toilet Less Seat		211CA004.020	White	490
Champion® PRO Two-Piece 1.6 gpf/6.0 Lpf Standard Height Right-Hand Trip Lever Elongated Toilet Less Seat		211CA005.020	White	520
Separate Components:				
Champion® PRO Standard Height Elongated Bowl	55 lb 25.1 kg	3195C101.020	White	260
Champion® PRO 1.6 gpf/6.0 Lpf 12-Inch Rough Tank	31 lb 14.1 kg	4225A004.020	White	230
Champion® PRO 1.6 gpf/6.0 Lpf 12-Inch Rough Right-Hand Trip Lever Tank		4225A005.020	White	260
Champion® PRO 12-Inch Rough Toilet Tank Cover	8 lb 3.7 kg	735171-400.020	White	98
Left-Hand Trip Lever	0 lb 0.2 kg	▷7381232-200.0020A	Polished Chrome	42
	0 lb 0.1 kg	▷7381232-200.0130A	Polished Nickel	46
	0 lb 0.2 kg	▷7381232-200.0200A	White	52
		▷7381232-200.2240A	Oil Rubbed Bronze	103
	0 lb 0.1 kg	▷7381232-200.2780A	Legacy Bronze	78
	0 lb 0.2 kg	▷7381232-200.2950A	Brushed Nickel	55
Right-Hand Trip Lever		▷7381232-201.2950A	Brushed Nickel	55
Optional Components:				
Champion® Slow-Close & Easy Lift-Off Elongated Toilet Seat	3 lb 1.6 kg	5321A65CT.020	White	98

▷ Parts Program (Non-Premier)

Other seat options

Additional tanks

Meets all ANSI/ASME Low Consumption, Water Conservation Requirements.

✦ Check your local codes to determine if 1.6 gpf/6.0 Lpf toilets are allowed in your area.

High Efficiency (1.28 gpf/4.8 Lpf) Toilets



Colony®3 Two-Piece 1.28 gpf/4.8 Lpf Chair-Height Elongated Toilet Less Seat

- Combination bowl and tank, less seat
- High efficiency toilet (HET), ultra-low consumption (1.28 gpf/4.8 Lpf), utilizes 20% less water
- Meets EPA WaterSense® criteria
- PowerWash® rim helps clean bowl with each flush
- 3" (76 mm) flush valve with 2" (51 mm) trapway for optimal flushing performance
- 16-½" (419 mm) rim height for accessible applications
- 12" (305 mm) rough-in
- Generous 9" x 8" (229 x 203 mm) water surface area
- Color-matched trip lever is supplied
- Limited lifetime warranty on chinaware, limited 2-year warranty on all mechanical parts, and limited 1-year warranty on seat which is purchased separately

Nominal Dimensions:

29-3/4 in x 17-15/16 in x 29-15/16 in (755 mm x 455 mm x 760 mm)



Description	Net Wt	SKU	Color	List Price
Colony®3 Two-Piece 1.28 gpf/4.8 Lpf Chair-Height Elongated Toilet Less Seat		250AA104.020	White	330

Separate Components:

Colony®3 Chair-Height Elongated Bowl	49 lb 22.4 kg	3437A101.020	White	223
Colony®3 1.28 gpf/4.8 Lpf Toilet Tank	27 lb 12.4 kg	4425A104.020	White	107
Colony/Evolution2/Colony®3 Toilet Tank Cover	7 lb 3.3 kg	735131-400.020	White	81
Left-Hand 30 Degree Plastic Toilet Trip Lever	0 lb 0.0 kg	▷047192-0020A	Polished Chrome	30
		▷047192-0200A	White	25

Optional Components:

Transitional Slow-Close Elongated Toilet Seat	2 lb 1.3 kg	5503A00B.020	White	57
---	----------------	--------------	-------	----

High Efficiency (1.28 gpf/4.8 Lpf) Toilets



Colony®3 Two-Piece 1.28 gpf/4.8 Lpf Elongated Toilet Less Seat

- Combination bowl and tank, less seat
- High efficiency toilet (HET), ultra-low consumption (1.28 gpf/4.8 Lpf), utilizes 20% less water
- Meets EPA WaterSense® criteria
- PowerWash® rim helps clean bowl with each flush
- 3" (76 mm) flush valve with 2" (51 mm) trapway for optimal flushing performance
- 12" (305 mm) rough-in
- Generous 9" x 8" (229 x 203 mm) water surface area
- Color-matched trip lever is supplied
- Limited lifetime warranty on chinaware, limited 2-year warranty on all mechanical parts, and limited 1-year warranty on seat which is purchased separately

Nominal Dimensions:

29-3/4 in x 17-15/16 in x 28-7/16 in (755 mm x 455 mm x 722 mm)



Description	Net Wt	SKU	Color	List Price
Colony®3 Two-Piece 1.28 gpf/4.8 Lpf Elongated Toilet Less Seat		250CA104.020	White	257

Separate Components:

Colony®3 Standard Height Elongated Bowl	43 lb 19.6 kg	3437C101.020	White	150
Colony®3 1.28 gpf/4.8 Lpf Toilet Tank	27 lb 12.4 kg	4425A104.020	White	107
Colony/Evolution2/Colony®3 Toilet Tank Cover	7 lb 3.3 kg	735131-400.020	White	81
Left-Hand 30 Degree Plastic Toilet Trip Lever	0 lb 0.0 kg	▷047192-0020A	Polished Chrome	30
		▷047192-0200A	White	25

Optional Components:

Transitional Slow-Close Elongated Toilet Seat	2 lb 1.3 kg	5503A00B.020	White	57
---	----------------	--------------	-------	----

High Efficiency (1.28 gpf/4.8 Lpf) Toilets



Colony®3 Two-Piece 1.28 gpf/4.8 Lpf Round-Front Toilet Less Seat

- Combination bowl and tank, less seat
- High efficiency toilet (HET), ultra-low consumption (1.28 gpf/4.8 Lpf), utilizes 20% less water
- Meets EPA WaterSense® criteria
- PowerWash® rim helps clean bowl with each flush
- 3" (76 mm) flush valve with 2" (51 mm) trapway for optimal flushing performance
- 12" (305 mm) rough-in
- Generous 9" x 8" (229 x 203 mm) water surface area
- Color-matched trip lever is supplied
- Limited lifetime warranty on chinaware, limited 2-year warranty on all mechanical parts, and limited 1-year warranty on seat which is purchased separately

Nominal Dimensions:

27-13/16 in x 17-15/16 in x 28-7/16 in (706 mm x 455 mm x 722 mm)



Description	Net Wt	SKU	Color	List Price
Colony®3 Two-Piece 1.28 gpf/4.8 Lpf Round-Front Toilet Less Seat		250DA104.020	White	214

Separate Components:

Colony®3 Standard Height Round-Front Bowl	40 lb 18.4 kg	3437D101.020	White	107
Colony®3 1.28 gpf/4.8 Lpf Toilet Tank	27 lb 12.4 kg	4425A104.020	White	107
Colony/Evolution2/Colony®3 Toilet Tank Cover	7 lb 3.3 kg	735131-400.020	White	81
Left-Hand 30 Degree Plastic Toilet Trip Lever	0 lb 0.0 kg	▷047192-0020A	Polished Chrome	30
		▷047192-0200A	White	25

Optional Components:

Transitional Slow-Close Round-Front Toilet Seat	2 lb 1.2 kg	5503B00B.020	White	51
---	----------------	--------------	-------	----

High Efficiency, Low Consumption – Full Flush (1.6 gpf/6.0 Lpf) – Conserving Flush (1.1 gpf/4.2 Lpf)



Edgemere® Two-Piece Dual Flush 1.6 gpf/6.0 Lpf and 1.1 gpf/4.2 Lpf Chair-Height Elongated Toilet Less Seat

- Combination bowl and tank, less seat
- 12" (305 mm) rough-in
- High efficiency, low consumption, full flush (1.6 gpf/6.0 Lpf), conserving flush (1.1 gpf/4.2 Lpf)
- Meets EPA WaterSense® criteria
- PowerWash® rim helps clean bowl with each flush
- Chrome top-of-tank push button actuator
- Includes EZ-Install Tools
- EverClean® Antimicrobial Surface
- 16-1/2" (419 mm) rim height for accessible application
- 2" (51 mm) fully glazed trapway
- 9" x 8" (229 x 203 mm) water surface area
- Five-year warranty
- Design coordinates with Edgemere® suite

Nominal Dimensions:

30-3/16 in x 17 in x 31-1/8 in (766 mm x 431 mm x 790 mm)



Description	Net Wt	SKU	Color	List Price
Edgemere® Two-Piece Dual Flush 1.6 gpf/6.0 Lpf and 1.1 gpf/4.2 Lpf Chair-Height Elongated Toilet Less Seat		204AA200.020	White	437

Separate Components:

Edgemere® Chair-Height Elongated Bowl	54 lb 24.7 kg	3519A101.020	White	224
Edgemere® Dual Flush 1.6 gpf/6.0 Lpf and 1.1 gpf/4.2 Lpf 12 in. Rough Tank	27 lb 12.4 kg	4519A200.020	White	213
Top-of-tank Actuator, Dual Flush	0 lb 0.1 kg	▷7381092-202.0020A	Polished Chrome	8

Optional Components:

Cardiff™ Slow-Close Elongated Toilet Seat	3 lb 1.5 kg	5257A65MT.020	White	71
---	----------------	---------------	-------	----

▷ Parts Program (Non-Premier)

Other seat options

Meets all ANSI/ASME Low Consumption, Water Conservation Requirements.

High Efficiency, Low Consumption – Full Flush (1.6 gpf/6.0 Lpf) – Conserving Flush (1.1 gpf/4.2 Lpf)



Edgemere® Two-Piece Dual Flush 1.6 gpf/6.0 Lpf and 1.1 gpf/4.2 Lpf Chair-Height Round-Front Toilet Less Seat

- Combination bowl and tank, less seat
- 12" (305 mm) rough-in
- High efficiency, low consumption, full flush (1.6 gpf/6.0 Lpf), conserving flush (1.1 gpf/4.2 Lpf)
- Meets EPA WaterSense® criteria
- PowerWash® rim helps clean bowl with each flush
- Chrome top-of-tank push button actuator
- Includes EZ-Install Tools
- EverClean® Antimicrobial Surface
- 16-1/2" (419 mm) rim height for accessible application
- 2" (51 mm) fully glazed trapway
- 9" x 8" (229 x 203 mm) water surface area
- Five-year warranty
- Design coordinates with Edgemere® suite

Nominal Dimensions:

28-3/16 in x 17 in x 31-1/8 in (715 mm x 431 mm x 790 mm)



Description	Net Wt	SKU	Color	List Price
Edgemere® Two-Piece Dual Flush 1.6 gpf/6.0 Lpf and 1.1 gpf/4.2 Lpf Chair-Height Round-Front Toilet Less Seat		204BA200.020	White	358

Separate Components:

Edgemere® Chair-Height Round-Front Bowl	52 lb 23.6 kg	3519B101.020	White	145
Edgemere® Dual Flush 1.6 gpf/6.0 Lpf and 1.1 gpf/4.2 Lpf 12 in. Rough Tank	27 lb 12.4 kg	4519A200.020	White	213
Top-of-tank Actuator, Dual Flush	0 lb 0.1 kg	▶7381092-202.0020A	Polished Chrome	8

Optional Components:

Cardiff™ Slow-Close Round Front Toilet Seat	3 lb 1.4 kg	5259B65MT.020	White	65
---	----------------	---------------	-------	----

▶ Parts Program (Non-Premier)

Other seat options

ADA when installed with provided seat, top of seat is 17" to 19" (432 to 483 mm) from the finished floor.

Meets all ANSI/ASME Low Consumption, Water Conservation Requirements.

High Efficiency (1.28 gpf/4.8 Lpf) Toilet



Edgemere® Two-Piece 1.28 gpf/4.8 Lpf Chair-Height Elongated Toilet Less Seat

- Combination bowl and tank, less seat
- 12" (305 mm) rough-in
- High efficiency, ultra-low consumption (1.28 gpf/4.8 Lpf), utilizes 20% less water
- Meets EPA WaterSense® criteria
- PowerWash® rim helps clean bowl with each flush
- Chrome trip lever
- Includes EZ-Install Tools
- EverClean® Antimicrobial Surface
- 16-1/2" (419 mm) rim height for accessible application
- 2" (51 mm) fully glazed trapway
- 9" x 8" (229 x 203 mm) water surface area
- 3" (76 mm) flush valve
- Five-year warranty
- Design coordinates with Edgemere® suite of fixtures

Nominal Dimensions:

30-3/16 in x 17 in x 31-1/8 in (766 mm x 431 mm x 790 mm)



Description	Net Wt	SKU	Color	List Price
Edgemere® Two-Piece 1.28 gpf/4.8 Lpf Chair-Height Elongated Toilet Less Seat		204AA104.020	White	360
Edgemere® Two-Piece 1.28 gpf/4.8 Lpf Chair-Height Elongated Right-Hand Trip Lever Toilet Less Seat		204AA105.020	White	380

Separate Components:

Edgemere® Chair-Height Elongated Bowl	54 lb 24.7 kg	3519A101.020	White	224
Edgemere® 1.28 gpf/4.8 Lpf 12 in. Rough Tank	27 lb 12.4 kg	4519A104.020	White	136
Edgemere® 1.28 gpf/4.8 Lpf 12 in. Rough Right-Hand Trip Lever Tank		4519A105.020	White	156
Edgemere® 12 in. Rough Toilet Tank Cover	6 lb 3.0 kg	735214-400.020	White	68
Left-Hand Trip Lever	0 lb 0.1 kg	▷7381741-200.0020A	Polished Chrome	42
		▷7381741-200.2430A	Matte Black	50
		▷7381741-200.2780A	Legacy Bronze	78
		▷7381741-200.2950A	Brushed Nickel	59
Right-Hand Trip Lever	0 lb 0.2 kg	▷7381232-201.2950A	Brushed Nickel	55

Optional Components:

Cardiff™ Slow-Close Elongated Toilet Seat	3 lb 1.5 kg	5257A65MT.020	White	71
---	----------------	---------------	-------	----

▷ Parts Program (Non-Premier)

Other seat options

ADA when installed with provided seat, top of seat is 17" to 19" (432 to 483 mm) from the finished floor.

Meets all ANSI/ASME Low Consumption, Water Conservation Requirements.

High Efficiency, Ultra-Low Consumption (1.28 gpf/4.8 Lpf)



AquaWash® 1.0 SpaLet® Bidet Seat and Edgemere® Chair Height Elongated 1.28 gpf/4.8 Lpf Toilet Combo

- Clean, graceful lines make it ideal for a powder room or a spa-like setting
- Chair height and elongated bowl for greater comfort
- High Efficiency Toilet (HET), ultra-low consumption (4.8 Lpf/1.28 gpf) utilizes 20% less water
- WaterSense® certified for water efficiency
- PowerWash® rim helps clean bowl with each flush
- Non-electric bidet feature with adjustable spray volume
- Independent self-cleaning dual nozzles for effective front and back cleansing
- "No Slam" slow-close seat and lid for user convenience
- One-push removable seat for easier cleaning of the seat and bowl
- Manual Side Lever : Easy to operate

Nominal Dimensions:

30-3/16 in x 17 in x 31-1/8 in (766 mm x 431 mm x 790 mm)



Description	Net Wt	SKU	Color	List Price
AquaWash® 1.0 SpaLet® Bidet Seat and Edgemere® Chair Height Elongated 1.28 gpf/4.8 Lpf Toilet Combo		602AA001.020	White	506
Separate Components:				
Edgemere® Chair-Height Elongated Bowl	54 lb 24.7 kg	3519A101.020	White	224
Edgemere® 1.28 gpf/4.8 Lpf 12 in. Rough Tank	27 lb 12.4 kg	4519A104.020	White	136
AquaWash® 1.0 Non-Electric SpaLet® Bidet Seat With Manual Operation	4 lb 2.0 kg	5900A05GT.020	White	146

ADA when installed with provided seat, top of seat is 17" to 19" (432 to 483 mm) from the finished floor.
Meets all ANSI/ASME Low Consumption, Water Conservation Requirements.

Edgemere® – SpaLet® Bundle

Two-Piece Toilets

High Efficiency, Ultra-Low Consumption (1.28 gpf/4.8 Lpf)



AquaWash® 2.0 SpaLet® Bidet Seat and Edgemere® Chair Height Elongated 1.28 gpf/4.8 Lpf Toilet Combo

- Clean, graceful lines make it ideal for a powder room or a spa-like setting
- Chair height and elongated bowl for greater comfort
- High Efficiency Toilet (HET), ultra-low consumption (4.8 Lpf/1.28 gpf) utilizes 20% less water
- WaterSense® certified for water efficiency
- PowerWash® rim helps clean bowl with each flush
- Independent self-cleaning dual nozzles for effective front and back cleansing
- Instant heating ensures constant availability of warm water
- Heated seat with two adjustable temperature for added comfort
- Adjustable water temperature of two temperature levels
- Soft night light guides you at night

Nominal Dimensions:

30-3/16 in x 17 in x 31-1/8 in (766 mm x 431 mm x 790 mm)



Description	Net Wt	SKU	Color	List Price
AquaWash® 2.0 SpaLet® Bidet Seat and Edgemere® Chair Height Elongated 1.28 gpf/4.8 Lpf Toilet Combo		602AA002.020	White	868
Separate Components:				
Edgemere® Chair-Height Elongated Bowl	54 lb 24.7 kg	3519A101.020	White	224
Edgemere® 1.28 gpf/4.8 Lpf 12 in. Rough Tank	27 lb 12.4 kg	4519A104.020	White	136
AquaWash® 2.0 Electric SpaLet® Bidet Seat With Manual Operation	7 lb 3.3 kg	8019A60GPC.020	White	508

Two-Piece Toilets

ADA when installed with provided seat, top of seat is 17" to 19" (432 to 483 mm) from the finished floor. Meets all ANSI/ASME Low Consumption, Water Conservation Requirements.

High Efficiency (1.28 gpf/4.8 Lpf) Toilets



Edgemere® Two-Piece 1.28 gpf/4.8 Lpf Chair-Height Round-Front Toilet Less Seat

- Combination bowl and tank, less seat
- 12" (305 mm) rough-in
- High efficiency, ultra-low consumption (1.28 gpf/4.8 Lpf), utilizes 20% less water
- Meets EPA WaterSense® criteria
- PowerWash® rim helps clean bowl with each flush
- Chrome trip lever
- Includes EZ-Install Tools
- EverClean® Antimicrobial Surface
- 16-1/2" (419 mm) rim height for accessible application
- 2" (51 mm) fully glazed trapway
- 9" x 8" (229 x 203 mm) water surface area
- 3" (76 mm) flush valve
- Five-year warranty
- Design coordinates with Edgemere® suite of fixtures

Nominal Dimensions:

28-3/16 in x 17 in x 31-1/8 in (715 mm x 431 mm x 790 mm)



Description	Net Wt	SKU	Color	List Price
Edgemere® Two-Piece 1.28 gpf/4.8 Lpf Chair-Height Round-Front Toilet Less Seat		204BA104.020	White	281
Edgemere® Two-Piece 1.28 gpf/4.8 Lpf Chair-Height Round-Front Right-Hand Trip Lever Toilet Less Seat		204BA105.020	White	281

Separate Components:

Edgemere® Chair-Height Round-Front Bowl	52 lb 23.6 kg	3519B101.020	White	145
Edgemere® 1.28 gpf/4.8 Lpf 12 in. Rough Tank	27 lb 12.4 kg	4519A104.020	White	136
Edgemere® 1.28 gpf/4.8 Lpf 12 in. Rough Right-Hand Trip Lever Tank		4519A105.020	White	156
Edgemere® 12 in. Rough Toilet Tank Cover	6 lb 3.0 kg	735214-400.020	White	68
Left-Hand Trip Lever	0 lb 0.1 kg	▷7381741-200.0020A	Polished Chrome	42
		▷7381741-200.2430A	Matte Black	50
		▷7381741-200.2780A	Legacy Bronze	78
		▷7381741-200.2950A	Brushed Nickel	59
Right-Hand Trip Lever	0 lb 0.2 kg	▷7381232-201.2950A	Brushed Nickel	55

Optional Components:

Cardiff™ Slow-Close Round Front Toilet Seat	3 lb 1.4 kg	5259B65MT.020	White	65
---	----------------	---------------	-------	----

▷ Parts Program (Non-Premier)

Other seat options

ADA when installed with provided seat, top of seat is 17" to 19" (432 to 483 mm) from the finished floor.

Meets all ANSI/ASME Low Consumption, Water Conservation Requirements.

High Efficiency (1.28 gpf/4.8 Lpf) Toilet



Edgemere® Two-Piece 1.28 gpf/4.8 Lpf Chair Height Elongated 10-Inch Rough Toilet Less Seat

- Combination bowl and tank, less seat
- 10" (254 mm) rough-in
- High efficiency, ultra-low consumption (1.28 gpf/4.8 Lpf), utilizes 20% less water
- Meets EPA WaterSense® criteria
- PowerWash® rim helps clean bowl with each flush
- Chrome trip lever
- Includes EZ-Install Tools
- EverClean® Antimicrobial Surface
- 16-1/2" (419 mm) rim height for accessible application
- 2" (51 mm) fully glazed trapway
- 9" x 8" (229 x 203 mm) water surface area
- 3" (76 mm) flush valve
- Five-year warranty
- Design coordinates with Edgemere® suite

Nominal Dimensions:

28-3/16 in x 18-7/8 in x 30-1/4 in (715 mm x 479 mm x 768 mm)



Description	Net Wt	SKU	Color	List Price
Edgemere® Two-Piece 1.28 gpf/4.8 Lpf Chair Height Elongated 10-Inch Rough Toilet Less Seat		204AB104.020	White	391
Separate Components:				
Edgemere® Chair-Height Elongated Bowl	54 lb 24.7 kg	3519A101.020	White	224
Edgemere® 1.28 gpf/4.8 Lpf 10 in. Rough Tank	27 lb 12.3 kg	4519B104.020	White	167
Edgemere® 10 in. Rough Toilet Tank Cover	8 lb 4.1 kg	735213-400.020	White	66
Left-Hand Trip Lever	0 lb 0.1 kg	▷7381741-200.0020A	Polished Chrome	42
		▷7381741-200.2430A	Matte Black	50
		▷7381741-200.2780A	Legacy Bronze	78
		▷7381741-200.2950A	Brushed Nickel	59
Optional Components:				
Cardiff™ Slow-Close Elongated Toilet Seat	3 lb 1.5 kg	5257A65MT.020	White	71

▷ Parts Program (Non-Premier)

Other seat options

ADA when installed with provided seat, top of seat is 17" to 19" (432 to 483 mm) from the finished floor.

Meets all ANSI/ASME Low Consumption, Water Conservation Requirements.

High Efficiency (1.28 gpf/4.8 Lpf) Toilet



Edgemere® Two-Piece 1.28 gpf/4.8 Lpf Chair-Height Round-Front 10-Inch Rough Toilet Less Seat

- Combination bowl and tank, less seat
- 10" (254 mm) rough-in
- High efficiency, ultra-low consumption (1.28 gpf/4.8 Lpf), utilizes 20% less water
- Meets EPA WaterSense® criteria
- PowerWash® rim helps clean bowl with each flush
- Chrome trip lever
- Includes EZ-Install Tools
- EverClean® Antimicrobial Surface
- 16-1/2" (419 mm) rim height for accessible application
- 2" (51 mm) fully glazed trapway
- 9" x 8" (229 x 203 mm) water surface area
- 3" (76 mm) flush valve
- Five-year warranty
- Design coordinates with Edgemere® suite

Nominal Dimensions:

26-3/16 in x 18-7/8 in x 30-5/16 in (665 mm x 479 mm x 769 mm)



Description	Net Wt	SKU	Color	List Price
Edgemere® Two-Piece 1.28 gpf/4.8 Lpf Chair-Height Round-Front 10 in. Rough Toilet Less Seat		204BB104.020	White	345

Separate Components:

Edgemere® Chair-Height Round-Front Bowl	52 lb 23.6 kg	3519B101.020	White	145
Edgemere® 1.28 gpf/4.8 Lpf 10 in. Rough Tank	27 lb 12.3 kg	4519B104.020	White	167
Edgemere® 10 in. Rough Toilet Tank Cover	8 lb 4.1 kg	735213-400.020	White	66
Left-Hand Trip Lever	0 lb 0.1 kg	▷7381741-200.0020A	Polished Chrome	42
		▷7381741-200.2430A	Matte Black	50
		▷7381741-200.2780A	Legacy Bronze	78
		▷7381741-200.2950A	Brushed Nickel	59

Optional Components:

Cardiff™ Slow-Close Round Front Toilet Seat	3 lb 1.4 kg	5259B65MT.020	White	65
---	----------------	---------------	-------	----

▷ Parts Program (Non-Premier)

Other seat options

ADA when installed with provided seat, top of seat is 17" to 19" (432 to 483 mm) from the finished floor.

Meets all ANSI/ASME Low Consumption, Water Conservation Requirements.

Ultra-High Efficiency (1.1 gpf/4.2 Lpf) Toilets



H2Optimum® Two-Piece 1.1 gpf/4.2 Lpf Chair Height Elongated Toilet Less Seat

- Siphonic action combination bowl and tank, less seat
- Ultra-High Efficiency Toilet (UHET) 1.1 gpf/4.2 Lpf
- Meets EPA WaterSense® and MaP PREMIUM criteria
- 16-1/2" (419 mm) rim height
- 12" (305 mm) rough-in
- EverClean® Antimicrobial Surface
- PowerWash® rim helps clean bowl with each flush
- 9" x 8" (229 x 203 mm) water surface area
- Chrome trip lever
- Sanitary dam on bowl
- 2" (51 mm) fully glazed trapway
- Two color-matched bolt caps
- Five-year warranty



Nominal Dimensions:

29-3/4 in x 15 in x 31-1/2 in (755 mm x 381 mm x 800 mm)

Description	Net Wt	SKU	Color	List Price
H2Optimum® Two-Piece 1.1 gpf/4.2 Lpf Chair Height Elongated Toilet Less Seat		288AA114.020	White	389
H2Optimum® Two-Piece 1.1 gpf/4.2 Lpf Chair Height Right-Hand Trip Lever Elongated Toilet Less Seat		288AA115.020	White	413

Separate Components:

H2Option® and H2Optimum® Chair Height Elongated Bowl	45 lb 20.6 kg	3705216.020	White	249
H2Optimum® 1.1 gpf/4.2 Lpf 12-Inch Rough Tank	30 lb 13.9 kg	4133A114.020	White	140
H2Optimum® 1.1 gpf/4.2 Lpf 12-Inch Rough Right-Hand Trip Lever Tank		4133A115.020	White	164
H2Option® ADA and H2Optimum® 12-Inch Rough Toilet Tank Cover	8 lb 3.9 kg	735177-400.020	White	91
Right-Hand Trip Lever	0 lb 0.2 kg	▷7381232-201.2950A	Brushed Nickel	55

Optional Components:

Cardiff™ Slow-Close Elongated Toilet Seat	3 lb 1.5 kg	5257A65MT.020	White	71
---	----------------	---------------	-------	----

▷ Parts Program (Non-Premier)

Other seat options

ADA when installed with provided seat, top of seat is 17" to 19" (432 to 483 mm) from the finished floor.

Meets all ANSI/ASME Low Consumption, Water Conservation Requirements.

Ultra-High Efficiency (1.1 gpf/4.2 Lpf) Toilet



H2Optimum® Two-Piece 1.1 gpf/4.2 Lpf Standard Height Elongated Toilet Less Seat

- Siphonic action combination bowl and tank, less seat
- Ultra-High Efficiency Toilet (UHET) 1.1 gpf/4.2 Lpf
- Meets EPA WaterSense® and MaP PREMIUM criteria
- 12" (305 mm) rough-in
- EverClean® Antimicrobial Surface
- PowerWash® rim helps clean bowl with each flush
- 9" x 8" (229 x 203 mm) water surface area
- Chrome trip lever
- Sanitary dam on bowl
- 2" (51 mm) fully glazed trapway
- Two color-matched bolt caps
- Five-year warranty



Nominal Dimensions:

29-3/4 in x 15 in x 30 in (755 mm x 381 mm x 762 mm)

Description	Net Wt	SKU	Color	List Price
H2Optimum® Two-Piece 1.1 gpf/4.2 Lpf Standard Height Elongated Toilet Less Seat		288CA114.020	White	353

Separate Components:

H2Option® and H2Optimum® Standard Height Elongated Bowl	43 lb 19.6 kg	3706216.020	White	213
H2Optimum® 1.1 gpf/4.2 Lpf 12-Inch Rough Tank	30 lb 13.9 kg	4133A114.020	White	140
H2Option® ADA and H2Optimum® 12-Inch Rough Toilet Tank Cover	8 lb 3.9 kg	735177-400.020	White	91

Optional Components:

Cardiff™ Slow-Close Elongated Toilet Seat	3 lb 1.5 kg	5257A65MT.020	White	71
---	----------------	---------------	-------	----

▷ Parts Program (Non-Premier)

Other seat options

Meets all ANSI/ASME Low Consumption, Water Conservation Requirements.

Ultra-High Efficiency (1.1 gpf/4.2 Lpf) Toilet



H2Optimum® Two-Piece 1.1 gpf/4.2 Lpf Standard Height Round Front Toilet Less Seat

- Siphonic action combination bowl and tank, less seat
- Ultra-High Efficiency Toilet (UHET) 1.1 gpf/4.2 Lpf
- Meets EPA WaterSense® and MaP PREMIUM criteria
- 12" (305 mm) rough-in
- EverClean® Antimicrobial Surface
- PowerWash® rim helps clean bowl with each flush
- 9" x 8" (229 x 203 mm) water surface area
- Chrome trip lever
- Sanitary dam on bowl
- 2" (51 mm) fully glazed trapway
- Two color-matched bolt caps
- Five-year warranty
- Round Front Toilet



Nominal Dimensions:

27-3/4 in x 15 in x 30 in (704 mm x 381 mm x 762 mm)

Description	Net Wt	SKU	Color	List Price
H2Optimum® Two-Piece 1.1 gpf/4.2 Lpf Standard Height Round Front Toilet Less Seat		288DA114.020	White	289
Separate Components:				
H2Option® and H2Optimum® Standard Height Round Front Bowl	41 lb 19.0 kg	3708216.020	White	149
H2Optimum® 1.1 gpf/4.2 Lpf 12-Inch Rough Tank	30 lb 13.9 kg	4133A114.020	White	140
H2Option® ADA and H2Optimum® 12-Inch Rough Toilet Tank Cover	8 lb 3.9 kg	735177-400.020	White	91
Optional Components:				
Cardiff™ Slow-Close Round Front Toilet Seat	3 lb 1.4 kg	5259B65MT.020	White	65

▷ Parts Program (Non-Premier)

Other seat options

Meets all ANSI/ASME Low Consumption, Water Conservation Requirements.

High Efficiency (1.28 gpf/4.8 Lpf) Full FLush – (0.92 gpf/3.5 Lpf) Conserving FlushToilets



H2Option® ADA Two-Piece Dual Flush 1.28 gpf/4.8 Lpf and 0.92 gpf/3.5 Lpf Chair Height Elongated Toilet Less Seat

- Siphonic action dual flush combination bowl and tank, less seat
- High efficiency, low consumption, full flush (1.28 gpf/4.8 Lpf), conserving flush (0.92 gpf/3.5 Lpf)
- Meets EPA WaterSense® and MaP PREMIUM criteria
- 16-1/2" (419 mm) rim height
- 12" (305 mm) rough-in
- EverClean® Antimicrobial Surface
- PowerWash® rim helps clean bowl with each flush
- 9" x 8" (229 x 203 mm) water surface area
- ADA compliant configuration with left-hand trip lever
- Sanitary dam on bowl
- 2" (51 mm) fully glazed trapway
- Two color-matched bolt caps
- Five-year warranty



Nominal Dimensions:

29-3/4 in x 15 in x 31-1/2 in (755 mm x 381 mm x 800 mm)

Description	Net Wt	SKU	Color	List Price
H2Option® ADA Two-Piece Dual Flush 1.28 gpf/4.8 Lpf and 0.92 gpf/3.5 Lpf Chair Height Elongated Toilet Less Seat		2886204.020	White	518
H2Option® ADA Two-Piece Dual Flush 1.28 gpf/4.8 Lpf and 0.92 gpf/3.5 Lpf Chair Height Right-Hand Trip Lever Elongated Toilet Less Seat		2886205.020	White	524

Separate Components:

H2Option® and H2Optimum® Chair Height Elongated Bowl	45 lb 20.6 kg	3705216.020	White	249
H2Option® ADA Dual Flush 1.28 gpf/4.8 Lpf and 0.92 gpf/3.5 Lpf 12-Inch Rough Tank	30 lb 13.9 kg	4133A204.020	White	269
H2Option® ADA Dual Flush 1.28 gpf/4.8 Lpf and 0.92 gpf/3.5 Lpf 12-Inch Rough Right Hand Trip Lever Tank		4133A205.020	White	275
H2Option® ADA and H2Optimum® 12-Inch Rough Toilet Tank Cover	8 lb 3.9 kg	735177-400.020	White	91
Left Hand Trip Lever	0 lb 0.2 kg	▷7381910-201.0020A	Polished Chrome	30
Right-Hand Trip Lever		▷7381910-200.0020A	Polished Chrome	30

Optional Components:

Cardiff™ Slow-Close Elongated Toilet Seat	3 lb 1.5 kg	5257A65MT.020	White	71
---	----------------	---------------	-------	----

▷ Parts Program (Non-Premier)

ADA when installed with provided seat, top of seat is 17" to 19" (432 to 483 mm) from the finished floor.

Meets all ANSI/ASME Low Consumption, Water Conservation Requirements.

High Efficiency (1.28 gpf/4.8 Lpf) Full FLush – (0.92 gpf/3.5 Lpf) Conserving FlushToilets



H2Option® Two-Piece Dual Flush 1.28 gpf/4.8 Lpf and 0.92 gpf/3.5 Lpf Chair Height Elongated Toilet Less Seat

- Siphonic action dual flush combination bowl and tank, less seat
- High efficiency, low consumption, full flush (1.28 gpf/4.8 Lpf), conserving flush (0.92 gpf/3.5 Lpf)
- Meets EPA WaterSense® and MaP PREMIUM criteria
- 16-1/2" (419 mm) rim height
- 12" (305 mm) rough-in
- EverClean® Antimicrobial Surface
- PowerWash® rim helps clean bowl with each flush
- 9" x 8" (229 x 203 mm) water surface area
- Chrome plated top-mounted push button actuator
- Sanitary dam on bowl
- 2" (51 mm) fully glazed trapway
- Two color-matched bolt caps
- Five-year warranty



Nominal Dimensions:

29-3/4 in x 15 in x 31-1/2 in (755 mm x 381 mm x 800 mm)

Description	Net Wt	SKU	Color	List Price
H2Option® Two-Piece Dual Flush 1.28 gpf/4.8 Lpf and 0.92 gpf/3.5 Lpf Chair Height Elongated Toilet Less Seat		2886218.020	White	510
H2Option® Two-Piece Dual Flush 1.28 gpf/4.8 Lpf and 0.92 gpf/3.5 Lpf Chair Height Elongated Toilet With Liner Less Seat		2886518.020	White	541

Separate Components:

H2Option® and H2Optimum® Chair Height Elongated Bowl	45 lb 20.6 kg	3705216.020	White	249
H2Option® Dual Flush 1.28 gpf/4.8 Lpf and 0.92 gpf/3.5 Lpf 12-Inch Rough Tank	26 lb 12.2 kg	4133A218.020	White	261
H2Option® Dual Flush 1.28 gpf/4.8 Lpf and 0.92 gpf/3.5 Lpf 12-Inch Rough Lined Tank		4133A518.020	White	292
H2Option® Dual Flush 12-Inch Rough Toilet Tank Cover	7 lb 3.3 kg	735138-400.020	White	77
Top-of-Tank Actuator, Dual Flush	0 lb 0.1 kg	▷7381092-201.0020A	Polished Chrome	8

Optional Components:

Cardiff™ Slow-Close Elongated Toilet Seat	3 lb 1.5 kg	5257A65MT.020	White	71
---	----------------	---------------	-------	----

▷ Parts Program (Non-Premier)

Other seat options

Meets all ANSI/ASME Low Consumption, Water Conservation Requirements.

High Efficiency (1.28 gpf/4.8 Lpf) Full FLush – (0.92 gpf/3.5 Lpf) Conserving FlushToilets



H2Option® Two-Piece Dual Flush 1.28 gpf/4.8 Lpf and 0.92 gpf/3.5 Lpf Standard Height Elongated Toilet Less Seat

- Siphonic action dual flush combination bowl and tank, less seat
- High efficiency, low consumption, full flush (1.28 gpf/4.8 Lpf), conserving flush (0.92 gpf/3.5 Lpf)
- Meets EPA WaterSense® and MaP PREMIUM criteria
- 12" (305 mm) rough-in
- EverClean® Antimicrobial Surface
- PowerWash® rim helps clean bowl with each flush
- 9" x 8" (229 x 203 mm) water surface area
- Chrome plated top-mounted push button actuator
- Sanitary dam on bowl
- 2" (51 mm) fully glazed trapway
- Two color-matched bolt caps
- Five-year warranty



Nominal Dimensions:

29-3/4 in x 15 in x 30 in (755 mm x 381 mm x 762 mm)

Description	Net Wt	SKU	Color	List Price
H2Option® Two-Piece Dual Flush 1.28 gpf/4.8 Lpf and 0.92 gpf/3.5 Lpf Standard Height Elongated Toilet Less Seat		2887218.020	White	474
H2Option® Two-Piece Dual Flush 1.28 gpf/4.8 Lpf and 0.92 gpf/3.5 Lpf Standard Height Elongated Toilet With Liner Less Seat		2887518.020	White	505

Separate Components:

H2Option® and H2Optimum® Standard Height Elongated Bowl	43 lb 19.6 kg	3706216.020	White	213
H2Option® Dual Flush 1.28 gpf/4.8 Lpf and 0.92 gpf/3.5 Lpf 12-Inch Rough Tank	26 lb 12.2 kg	4133A218.020	White	261
H2Option® Dual Flush 1.28 gpf/4.8 Lpf and 0.92 gpf/3.5 Lpf 12-Inch Rough Lined Tank		4133A518.020	White	292
H2Option® Dual Flush 12-Inch Rough Toilet Tank Cover	7 lb 3.3 kg	735138-400.020	White	77
Top-of-Tank Actuator, Dual Flush	0 lb 0.1 kg	▷7381092-201.0020A	Polished Chrome	8

Optional Components:

Cardiff™ Slow-Close Elongated Toilet Seat	3 lb 1.5 kg	5257A65MT.020	White	71
---	----------------	---------------	-------	----

▷ Parts Program (Non-Premier)

Other seat options

Meets all ANSI/ASME Low Consumption, Water Conservation Requirements.

High Efficiency (1.28 gpf/4.8 Lpf) Full FLush – (0.92 gpf/3.5 Lpf) Conserving FlushToilets



H2Option® Two-Piece Dual Flush 1.28 gpf/4.8 Lpf and 0.92 gpf/3.5 Lpf Standard Height Round Front Toilet Less Seat

- Siphonic action dual flush combination bowl and tank, less seat
- High efficiency, low consumption, full flush (1.28 gpf/4.8 Lpf), conserving flush (0.92 gpf/3.5 Lpf)
- Meets EPA WaterSense® and MaP PREMIUM criteria
- 12" (305 mm) rough-in
- EverClean® Antimicrobial Surface
- PowerWash® rim helps clean bowl with each flush
- 9" x 8" (229 x 203 mm) water surface area
- Chrome plated top-mounted push button actuator
- Sanitary dam on bowl
- 2" (51 mm) fully glazed trapway
- Two color-matched bolt caps
- Five-year warranty



Nominal Dimensions:

27-3/4 in x 15 in x 30 in (704 mm x 381 mm x 762 mm)

Description	Net Wt	SKU	Color	List Price
H2Option® Two-Piece Dual Flush 1.28 gpf/4.8 Lpf and 0.92 gpf/3.5 Lpf Standard Height Round Front Toilet Less Seat		2889218.020	White	410
H2Option® Two-Piece Dual Flush 1.28 gpf/4.8 Lpf and 0.92 gpf/3.5 Lpf Standard Height Round Front Toilet With Liner Less Seat		2889518.020	White	441

Separate Components:

H2Option® and H2Optimum® Standard Height Round Front Bowl	41 lb 19.0 kg	3708216.020	White	149
H2Option® Dual Flush 1.28 gpf/4.8 Lpf and 0.92 gpf/3.5 Lpf 12-Inch Rough Tank	26 lb 12.2 kg	4133A218.020	White	261
H2Option® Dual Flush 1.28 gpf/4.8 Lpf and 0.92 gpf/3.5 Lpf 12-Inch Rough Lined Tank		4133A518.020	White	292
H2Option® Dual Flush 12-Inch Rough Toilet Tank Cover	7 lb 3.3 kg	735138-400.020	White	77
Top-of-Tank Actuator, Dual Flush	0 lb 0.1 kg	▷7381092-201.0020A	Polished Chrome	8

Optional Components:

Cardiff™ Slow-Close Round Front Toilet Seat	3 lb 1.4 kg	5259B65MT.020	White	65
---	----------------	---------------	-------	----

▷ Parts Program (Non-Premier)

Other seat options

Meets all ANSI/ASME Low Consumption, Water Conservation Requirements.

High Efficiency (1.28 gpf/4.8 Lpf) Toilet



Heritage® VorMax® Two-Piece 1.28 gpf/4.8 Lpf Chair Height Elongated Toilet less Seat

- Two patented flush valves and maximum rinsing power for the cleanest flush*
- Combination bowl and tank, less seat
- 12" (305 mm) rough-in
- Chair Height elongated siphon action bowl
- High efficiency, ultra-low consumption (1.28 gpf/4.8 Lpf), utilizes 20% less water
- Meets EPA WaterSense® criteria
- EverClean® Antimicrobial Surface
- Classic American traditional styling
- CleanCurve® rim eliminates rim area where dirt and build-up hide
- 16-½" (419 mm) rim height for accessible applications
- 2-1/16" (52 mm) trapway
- Dual injection flush valves
- Chrome trip lever
- Two color-matched bolt caps
- 10-year warranty
- Design coordinates with Retrospect® suite

Nominal Dimensions:

30-1/4 in x 19-3/4 in x 30-13/16 in (768 mm x 501 mm x 782 mm)



Description	Net Wt	SKU	Color	List Price
Heritage® VorMax® Two-Piece 1.28 gpf/4.8 Lpf Chair Height Elongated Toilet less Seat		205AA104.020	White	515

Separate Components:

Heritage® VorMax® Chair Height Elongated Bowl	58 lb 26.3 kg	3870A101.020	White	262
Heritage VorMax 1.28 gpf/4.8 Lpf 12-Inch Rough Tank Only	31 lb 14.5 kg	4270A104.020	White	253
Heritage Vormax 12-in. Rough-In Toilet Tank Cover	7 lb 3.4 kg	735203-410.020	White	111
Left-Hand Trip Lever	0 lb 0.2 kg	▷7381459-200.0020A	Polished Chrome	74

Optional Components:

Traditional Slow-Close & Easy Lift-Off Elongated Toilet Seat	6 lb 3.0 kg	5020A65G.020	White	131
Cadet® 3 Slow-Close Elongated Toilet Seat	4 lb 2.0 kg	5350110.020	White	81

▷ Parts Program (Non-Premier)

ADA when installed with provided seat, top of seat is 17" to 19" (432 to 483 mm) from the finished floor.

Meets all ANSI/ASME Low Consumption, Water Conservation Requirements.

*Compared to American Standard Champion toilets.

High Efficiency (1.28 gpf/4.8 Lpf) Toilets



Portsmouth® Champion® PRO Two-Piece 1.28 gpf/4.8 Lpf Chair Height Elongated Toilet Less Seat

- Combination bowl and tank, less seat
- High efficiency, ultra-low consumption (1.28 gpf/4.8 Lpf), utilizes 20% less water
- Meets EPA WaterSense® criteria
- Trade specific tank
- PowerWash® rim helps clean bowl with each flush
- Metal trip lever
- Metal shank fill valve
- Includes EZ-Install Tools
- EverClean® Antimicrobial Surface
- 4" (102 mm) piston-action Accelerator™ flush valve
- 2-3/8" (60 mm) fully-glazed trapway
- 16-1/2" (419 mm) rim height for accessible applications
- 12" (305 mm) rough-in
- 10-year warranty
- Design coordinates with Portsmouth® suite of fixtures

Nominal Dimensions:

30-1/4 in x 16-5/8 in x 31-1/8 in (768 mm x 422 mm x 790 mm)



Description	Net Wt	SKU	Color	List Price
Portsmouth® Champion® PRO Two-Piece 1.28 gpf/4.8 Lpf Chair Height Elongated Toilet Less Seat		213AA104.020	White	630

Separate Components:

Champion® PRO Chair Height Elongated Bowl	57 lb 25.9 kg	3195A101.020	White	303
Portsmouth® Champion® PRO 1.28 gpf/4.8 Lpf 12-Inch Rough Tank	30 lb 14.0 kg	4327A104.020	White	327
Portsmouth® Champion® PRO 12-Inch Rough Toilet Tank Cover	7 lb 3.5 kg	735202-400.020	White	103
Left-Hand Trip Lever	0 lb 0.3 kg	▷7381406-200.0020A	Polished Chrome	46
		▷7381406-200.2240A	Oil Rubbed Bronze	94
		▷7381406-200.2950A	Brushed Nickel	67

Optional Components:

Traditional Slow-Close & Easy Lift-Off Elongated Toilet Seat	6 lb 3.0 kg	5020A65G.020	White	131
Champion® Slow-Close & Easy Lift-Off Elongated Toilet Seat	3 lb 1.6 kg	5321A65CT.020	White	98

▷ Parts Program (Non-Premier)

Other seat options

ADA when installed with provided seat, top of seat is 17" to 19" (432 to 483 mm) from the finished floor.

Meets all ANSI/ASME Low Consumption, Water Conservation Requirements.

High Efficiency (1.28 gpf/4.8 Lpf) Toilet



Portsmouth® Champion® PRO Two-Piece 1.28 gpf/4.8 Lpf Chair Height Round Front Toilet

- Combination bowl and tank, less seat
- High efficiency, ultra-low consumption (1.28 gpf/4.8 Lpf), utilizes 20% less water
- Meets EPA WaterSense® criteria
- Trade specific tank
- PowerWash® rim helps clean bowl with each flush
- Metal trip lever
- Metal shank fill valve
- Includes EZ-Install Tools
- EverClean® Antimicrobial Surface
- 4" (102 mm) piston-action Accelerator™ flush valve
- 2-3/8" (60 mm) fully-glazed trapway
- 16-1/2" (419 mm) rim height for accessible applications
- 12" (305 mm) rough-in
- 10-year warranty
- Design coordinates with Portsmouth suite of fixtures and faucets
- Round Front Toilet Less Seat

Nominal Dimensions:

28-1/4 in x 16-5/8 in x 31-1/8 in (717 mm x 422 mm x 790 mm)



Description	Net Wt	SKU	Color	List Price
Portsmouth® Champion® PRO Two-Piece 1.28 gpf/4.8 Lpf Chair Height Round Front Toilet		213BA104.020	White	574

Separate Components:

Champion® PRO Chair Height Round Front Bowl	57 lb 25.9 kg	3195B101.020	White	247
Portsmouth® Champion® PRO 1.28 gpf/4.8 Lpf 12-Inch Rough Tank	30 lb 14.0 kg	4327A104.020	White	327
Portsmouth® Champion® PRO 12-Inch Rough Toilet Tank Cover	7 lb 3.5 kg	735202-400.020	White	103
Left-Hand Trip Lever	0 lb 0.3 kg	▷7381406-200.0020A	Polished Chrome	46
		▷7381406-200.2240A	Oil Rubbed Bronze	94
		▷7381406-200.2950A	Brushed Nickel	67

Optional Components:

Champion® Slow-Close & Easy Lift-Off Round Front Toilet Seat	3 lb 1.4 kg	5320B65CT.020	White	83
--	----------------	---------------	-------	----

▷ Parts Program (Non-Premier)

Other seat options

ADA when installed with provided seat, top of seat is 17" to 19" (432 to 483 mm) from the finished floor.

Meets all ANSI/ASME Low Consumption, Water Conservation Requirements.

High Efficiency (1.28 gpf/4.8 Lpf) Toilet



Portsmouth® Champion® PRO Two-Piece 1.28 gpf/4.8 Lpf Standard Height Elongated Toilet Less Seat

- Combination bowl and tank, less seat
- High efficiency, ultra-low consumption (1.28 gpf/4.8 Lpf), utilizes 20% less water
- Meets EPA WaterSense® criteria
- Trade specific tank
- PowerWash® rim helps clean bowl with each flush
- Metal trip lever
- Metal shank fill valve
- Includes EZ-Install Tools
- EverClean® Antimicrobial Surface
- 4" (102 mm) piston-action Accelerator™ flush valve
- 2-3/8" (60 mm) fully-glazed trapway
- 12" (305 mm) rough-in
- 10-year warranty
- Design coordinates with Portsmouth® suite of fixtures

Nominal Dimensions:

30-1/4 in x 16-5/8 in x 29-3/8 in (768 mm x 422 mm x 746 mm)



Description	Net Wt	SKU	Color	List Price
Portsmouth® Champion® PRO Two-Piece 1.28 gpf/4.8 Lpf Standard Height Elongated Toilet Less Seat		213CA104.020	White	587

Separate Components:

Champion® PRO Standard Height Elongated Bowl	55 lb 25.1 kg	3195C101.020	White	260
Portsmouth® Champion® PRO 1.28 gpf/4.8 Lpf 12-Inch Rough Tank	30 lb 14.0 kg	4327A104.020	White	327
Portsmouth® Champion® PRO 12-Inch Rough Toilet Tank Cover	7 lb 3.5 kg	735202-400.020	White	103
Left-Hand Trip Lever	0 lb 0.3 kg	▷7381406-200.0020A	Polished Chrome	46
		▷7381406-200.2240A	Oil Rubbed Bronze	94
		▷7381406-200.2950A	Brushed Nickel	67

Optional Components:

Traditional Slow-Close & Easy Lift-Off Elongated Toilet Seat	6 lb 3.0 kg	5020A65G.020	White	131
Champion® Slow-Close & Easy Lift-Off Elongated Toilet Seat	3 lb 1.6 kg	5321A65CT.020	White	98

▷ Parts Program (Non-Premier)

Other seat options

Meets all ANSI/ASME Low Consumption, Water Conservation Requirements.

High Efficiency (1.28 gpf/4.8 Lpf) Toilets



Retrospect Champion PRO Two-Piece 1.28 gpf/4.8 Lpf Chair Height Elongated Toilet less Seat

- Combination bowl and tank, less seat
- High efficiency, ultra-low consumption (1.28 gpf/4.8 Lpf), utilizes 20% less water
- Meets EPA WaterSense® criteria
- Trade specific tank
- PowerWash® rim helps clean bowl with each flush
- Metal trip lever
- Metal shank fill valve
- Includes EZ-Install Tools
- EverClean® Antimicrobial Surface
- 4" (102 mm) piston-action Accelerator™ flush valve
- 2-3/8" (60 mm) fully-glazed trapway
- 16-1/2" (419 mm) rim height for accessible applications
- 12" (305 mm) rough-in
- 10-year warranty
- Design coordinates with Retrospect® console table and pedestal sink

Nominal Dimensions:

30-1/4 in x 19-3/4 in x 31-1/2 in (768 mm x 501 mm x 800 mm)



Description	Net Wt	SKU	Color	List Price
Retrospect Champion PRO Two-Piece 1.28 gpf/4.8 Lpf Chair Height Elongated Toilet less Seat		212AA104.020	White	620

Separate Components:

Champion® PRO Chair Height Elongated Bowl	57 lb 25.9 kg	3195A101.020	White	303
Retrospect® Champion® PRO 1.28 gpf/4.8 Lpf 12-Inch Rough Tank	32 lb 14.7 kg	4326A104.020	White	317
Retrospect® Champion® PRO 12-Inch Rough Toilet Tank Cover	9 lb 4.2 kg	735201-400.020	White	103
Left-Hand Trip Lever	0 lb 0.3 kg	▷7381406-200.0020A	Polished Chrome	46
		▷7381406-200.2240A	Oil Rubbed Bronze	94
		▷7381406-200.2950A	Brushed Nickel	67

Optional Components:

Traditional Slow-Close & Easy Lift-Off Elongated Toilet Seat	6 lb 3.0 kg	5020A65G.020	White	131
Champion® Slow-Close & Easy Lift-Off Elongated Toilet Seat	3 lb 1.6 kg	5321A65CT.020	White	98

▷ Parts Program (Non-Premier)

Other seat options

ADA when installed with provided seat, top of seat is 17" to 19" (432 to 483 mm) from the finished floor.

Meets all ANSI/ASME Low Consumption, Water Conservation Requirements.

High Efficiency (1.28 gpf/4.8 Lpf) Toilet



Retrospect® Champion® PRO Two-Piece 1.28 gpf/4.8 Lpf Chair Height Round Front Toilet

- Combination bowl and tank, less seat
- High efficiency, ultra-low consumption (1.28 gpf/4.8 Lpf), utilizes 20% less water
- Meets EPA WaterSense® criteria
- Trade specific tank
- PowerWash® rim helps clean bowl with each flush
- Metal trip lever
- Metal shank fill valve
- Includes EZ-Install Tools
- EverClean® Antimicrobial Surface
- 4" (102 mm) piston-action Accelerator™ flush valve
- 2-3/8" (60 mm) fully-glazed trapway
- 16-1/2" (419 mm) rim height for accessible applications
- 12" (305 mm) rough-in
- 10-year warranty
- Design coordinates with Retrospect console table and pedestal sink

Nominal Dimensions:

28-1/4 in x 19-3/4 in x 31-1/2 in (717 mm x 501 mm x 800 mm)



Description	Net Wt	SKU	Color	List Price
Retrospect® Champion® PRO Two-Piece 1.28 gpf/4.8 Lpf Chair Height Round Front Toilet		212BA104.020	White	564

Separate Components:

Champion® PRO Chair Height Round Front Bowl	57 lb 25.9 kg	3195B101.020	White	247
Retrospect® Champion® PRO 1.28 gpf/4.8 Lpf 12-Inch Rough Tank	32 lb 14.7 kg	4326A104.020	White	317
Retrospect® Champion® PRO 12-Inch Rough Toilet Tank Cover	9 lb 4.2 kg	735201-400.020	White	103
Left-Hand Trip Lever	0 lb 0.3 kg	▷7381406-200.0020A	Polished Chrome	46
		▷7381406-200.2240A	Oil Rubbed Bronze	94
		▷7381406-200.2950A	Brushed Nickel	67

Optional Components:

Champion® Slow-Close & Easy Lift-Off Round Front Toilet Seat	3 lb 1.4 kg	5320B65CT.020	White	83
--	----------------	---------------	-------	----

▷ Parts Program (Non-Premier)

Other seat options

ADA when installed with provided seat, top of seat is 17" to 19" (432 to 483 mm) from the finished floor.

Meets all ANSI/ASME Low Consumption, Water Conservation Requirements.

High Efficiency (1.28 gpf/4.8 Lpf) Toilet



Retrospect Champion PRO Two-Piece 1.28 gpf/4.8 Lpf Standard Height Elongated Toilet less Seat

- Combination bowl and tank, less seat
- High efficiency, ultra-low consumption (1.28 gpf/4.8 Lpf), utilizes 20% less water
- Meets EPA WaterSense® criteria
- Trade specific tank
- PowerWash® rim helps clean bowl with each flush
- Metal trip lever
- Metal shank fill valve
- Includes EZ-Install Tools
- EverClean® Antimicrobial Surface
- 4" (102 mm) piston-action Accelerator™ flush valve
- 2-3/8" (60 mm) fully-glazed trapway
- 12" (305 mm) rough-in
- 10-year warranty
- Design coordinates with Retrospect® suite of fixtures and faucets

Nominal Dimensions:

30-1/4 in x 19-3/4 in x 30 in (768 mm x 501 mm x 762 mm)



Description	Net Wt	SKU	Color	List Price
Retrospect Champion PRO Two-Piece 1.28 gpf/4.8 Lpf Standard Height Elongated Toilet less Seat		212CA104.020	White	577

Separate Components:

Champion® PRO Standard Height Elongated Bowl	55 lb 25.1 kg	3195C101.020	White	260
Retrospect® Champion® PRO 1.28 gpf/4.8 Lpf 12-Inch Rough Tank	32 lb 14.7 kg	4326A104.020	White	317
Retrospect® Champion® PRO 12-Inch Rough Toilet Tank Cover	9 lb 4.2 kg	735201-400.020	White	103
Left-Hand Trip Lever	0 lb 0.3 kg	▷7381406-200.0020A	Polished Chrome	46
		▷7381406-200.2240A	Oil Rubbed Bronze	94
		▷7381406-200.2950A	Brushed Nickel	67

Optional Components:

Traditional Slow-Close & Easy Lift-Off Elongated Toilet Seat	6 lb 3.0 kg	5020A65G.020	White	131
Champion® Slow-Close & Easy Lift-Off Elongated Toilet Seat	3 lb 1.6 kg	5321A65CT.020	White	98

▷ Parts Program (Non-Premier)

Other seat options

Meets all ANSI/ASME Low Consumption, Water Conservation Requirements.

High Efficiency (1.28 gpf/4.8 Lpf) Toilets



Studio® S Skirted Two-Piece 1.28 gpf/4.8 Lpf Chair Height Elongated Toilet With Seat

- LXP® (Luxury Performance) toilet
- Combination bowl and tank, with seat
- 12" (305 mm) rough-in
- Chair Height elongated siphon action bowl with smooth-sided, concealed trapway
- High efficiency, ultra-low consumption (1.28 gpf/4.8 Lpf), utilizes 20% less water
- Meets EPA WaterSense® criteria
- EverClean® Antimicrobial Surface
- Contemporary styling
- PowerWash® rim helps clean bowl with each flush
- 16-1/2" (419 mm) rim height for accessible applications
- 2-1/8" (54 mm) trapway
- 3" (76 mm) flush valve
- Chrome trip lever matches Studio S faucets and accessories
- Includes slow-close seat and cover with easy lift-off feature
- Two color-matched bolt hole covers
- 10-year warranty
- Design coordinates with Studio® S suite

Nominal Dimensions:

28 in x 18-7/8 in x 31 in (711 mm x 479 mm x 787 mm)



Description	Net Wt	SKU	Color	List Price
Studio® S Skirted Two-Piece 1.28 gpf/4.8 Lpf Chair Height Elongated Toilet With Seat		226AA104.020	White	723
Studio® S Concealed Trapway 1.28 gpf/4.8 Lpf Right-Hand Trip Lever Chair Height Elongated Toilet With Slow Close Seat		226AA105.020	White	728

Separate Components:

Studio® S Concealed Trapway Chair Height Elongated Toilet Bowl With Seat	80 lb 36.3 kg	3712A100.020	White	561
Studio® S Concealed Trapway 1.28 gpf Toilet Tank	26 lb 11.8 kg	4162A104.020	White	162
Studio® S Concealed Trapway 1.28 gpf Toilet Tank With Right-Hand Trip Lever		4162A105.020	White	167
Studio® S 12-Inch Rough-In Toilet Tank Cover	7 lb 3.2 kg	735230-400.020	White	76
Left-Hand Trip Lever	0 lb 0.2 kg	▷7381920-200.0020A	Polished Chrome	30
		▷7381920-200.2430A	Matte Black	58
		▷7381920-200.2950A	Brushed Nickel	52

▷ Parts Program (Non-Premier)

ADA when installed with provided seat, top of seat is 17" to 19" (432 to 483 mm) from the finished floor.

Meets all ANSI/ASME Low Consumption, Water Conservation Requirements.

High Efficiency (1.6 gpf/6.0 Lpf) Full FLush – (1.1 gpf/4.2 Lpf) Conserving Flush Toilet



Studio® Skirted Two-Piece Dual Flush 1.6 gpf/6.0 Lpf and 1.1 gpf/4.2 Lpf Chair Height Elongated Toilet With Seat

- LXP® (Luxury Performance) toilet
- Combination dual flush bowl and tank, with seat
- Siphon action jetted bowl with smooth-sided, concealed trapway
- 12" (305 mm) rough-in
- High efficiency, low consumption, full flush (1.6 gpf/6.0 Lpf), conserving flush (1.1 gpf/4.2 Lpf), utilizes 31% less water
- Meets EPA WaterSense® criteria
- EverClean® Antimicrobial Surface
- PowerWash® rim helps clean bowl with each flush
- 16-1/2" (419 mm) rim height
- 2-1/8" (54 mm) fully glazed trapway
- 3" (76 mm) flush valve
- 9" x 8" (229 x 203 mm) water surface area
- Includes slow-close seat and cover with concealed seat ring and easy lift-off feature
- Chrome plated top-mounted push button actuator
- Two color-matched bolt hole covers
- Five-year warranty, one-year warranty on seat
- Design coordinates with Studio® lavatories

Nominal Dimensions:

30-1/4 in x 15-3/4 in x 30-3/4 in (768 mm x 400 mm x 781 mm)



Description	Net Wt	SKU	Color	List Price
Studio® Skirted Two-Piece Dual Flush 1.6 gpf/6.0 Lpf and 1.1 gpf/4.2 Lpf Chair Height Elongated Toilet With Seat		2794204.020	White	680

Separate Components:

Studio® Skirted Chair Height Elongated Bowl With Seat	72 lb 33.1 kg	3075120.020	White	517
Studio® Dual Flush 1.6 gpf/6.0 Lpf and 1.1 gpf/4.2 Lpf 12-Inch Rough Tank	29 lb 13.3 kg	4000204.020	White	163
Studio® Dual Flush 12-Inch Rough Toilet Tank Cover	10 lb 4.5 kg	735168-400.020	White	74
Telescoping Slow-Close Easy Lift-Off Elongated Toilet Seat	4 lb 2.0 kg	5025A65G.020	White	131
Top Mount Dual Flush Push Button	0 lb 0.1 kg	▷7381203-201.0070A	No Finish	15

Two-Piece Toilets

▷ Parts Program (Non-Premier)

Meets all ANSI/ASME Low Consumption, Water Conservation Requirements.

High Efficiency (1.6 gpf/6.0 Lpf) Full FLush – (1.1 gpf/4.2 Lpf) Conserving Flush Toilet



Studio Skirted Two-Piece Dual Flush 1.6 gpf/6.0 Lpf and 1.1 gpf/4.2 Lpf Chair Height Round Front Toilet With Seat

- LXP® (Luxury Performance) toilet
- Combination dual flush bowl and tank, with seat
- Siphon action jetted bowl with smooth-sided, concealed trapway
- 12" (305 mm) rough-in
- High efficiency, low consumption, full flush (1.6 gpf/6.0 Lpf), conserving flush (1.1 gpf/4.2 Lpf), utilizes 31% less water
- Meets EPA WaterSense® criteria
- EverClean® Antimicrobial Surface
- PowerWash® rim helps clean bowl with each flush
- 16-1/2" (419 mm) rim height
- 2-1/8" (54 mm) fully glazed trapway
- 3" (76 mm) flush valve
- 9" x 8" (229 x 203 mm) water surface area
- Includes slow-close seat and cover with concealed seat ring and easy lift-off feature for simple removal and reattachment for cleaning
- Chrome plated top-mounted push button actuator
- Two color-matched bolt hole covers
- Five-year warranty, one-year warranty on seat
- Design coordinates with Studio lavatories

Nominal Dimensions:

28-1/4 in x 15-3/4 in x 30-3/4 in (717 mm x 400 mm x 781 mm)



Description	Net Wt	SKU	Color	List Price
Studio Skirted Two-Piece Dual Flush 1.6 gpf/6.0 Lpf and 1.1 gpf/4.2 Lpf Chair Height Round Front Toilet With Seat		2795204.020	White	648

Separate Components:

Studio® Skirted Chair Height Round Front Bowl With Seat	68 lb 31.1 kg	3053120.020	White	485
Studio® Dual Flush 1.6 gpf/6.0 Lpf and 1.1 gpf/4.2 Lpf 12-Inch Rough Tank	29 lb 13.3 kg	4000204.020	White	163
Studio® Dual Flush 12-Inch Rough Toilet Tank Cover	10 lb 4.5 kg	735168-400.020	White	74
Telescoping Slow-Close & Easy Lift-Off Round Front Toilet Seat	4 lb 1.9 kg	5025B65G.020	White	120
Top Mount Dual Flush Push Button	0 lb 0.1 kg	▶7381203-201.0070A	No Finish	15

▷ Parts Program (Non-Premier)

Meets all ANSI/ASME Low Consumption, Water Conservation Requirements.

High Efficiency (1.28 gpf/4.8 Lpf) Toilet



Town Square® S Skirted Two-Piece 1.28 gpf/4.8 Lpf Chair Height Elongated Toilet With Seat

- LXP® (Luxury Performance) toilet
- Combination bowl and tank, with seat
- 12" (305 mm) rough-in
- Chair Height elongated siphon action bowl with smooth-sided, concealed trapway
- High efficiency, ultra-low consumption (1.28 gpf/4.8 Lpf), utilizes 20% less water
- Meets EPA WaterSense® criteria
- EverClean® Antimicrobial Surface
- Classic American traditional styling
- PowerWash® rim helps clean bowl with each flush
- 16-1/2" (419 mm) rim height for accessible applications
- 2-1/8" (54 mm) trapway
- 3" (76 mm) flush valve
- Chrome trip lever matches Town Square® S faucets and accessories
- Includes slow-close seat and cover with easy lift-off feature
- Two color-matched bolt hole covers
- 10-year warranty
- Design coordinates with Town Square® S suite

Nominal Dimensions:

30-1/4 in x 16-5/8 in x 31 in (768 mm x 422 mm x 787 mm)



Description	Net Wt	SKU	Color	List Price
Town Square® S Skirted Two-Piece 1.28 gpf/4.8 Lpf Chair Height Elongated Toilet With Seat		281AA104.020	White	799
		281AA104.222	Linen	1,001

Separate Components:

Town Square® S Skirted Chair Height Elongated Bowl With Seat	83 lb	3851A101.020	White	431
	37.7 kg	3851A101.222	Linen	540
Town Square® S 1.28 gpf/4.8 Lpf 12-Inch Rough Tank	28 lb	4216228.020	White	368
	12.9 kg	4216228.222	Linen	461
Town Square® S 12-Inch Rough Toilet Tank Cover	9 lb	735219-400.020	White	114
	4.3 kg	735219-400.222	Linen	141
Traditional Slow-Close & Easy Lift-Off Elongated Toilet Seat	6 lb	5020A65G.020	White	131
	3.0 kg	5020A65G.222	Linen	162
Left-Hand Trip Lever	0 lb 0.3 kg	▷7381105-0020A	Polished Chrome	44
		▷7381105-0130A	Polished Nickel	58
		▷7381105-2240A	Oil Rubbed Bronze	109
		▷7381105-2780A	Legacy Bronze	72
		▷7381105-2950A	Brushed Nickel	63

▷ Parts Program (Non-Premier)

ADA when installed with provided seat, top of seat is 17" to 19" (432 to 483 mm) from the finished floor.

Meets all ANSI/ASME Low Consumption, Water Conservation Requirements.

High Efficiency (1.28 gpf/4.8 Lpf) Toilets



Town Square® S Two-Piece 1.28 gpf/4.8 Lpf Chair Height Elongated Toilet Less Seat

- LXP® (Luxury Performance) toilet
- Combination bowl and tank, less seat
- 12" (305 mm) rough-in
- Chair Height elongated siphon action bowl with exposed trapway
- High efficiency, ultra-low consumption (1.28 gpf/4.8 Lpf), utilizes 20% less water
- Meets EPA WaterSense® criteria
- EverClean® Antimicrobial Surface
- PowerWash® rim helps clean bowl with each flush
- 16-1/2" (419 mm) rim height for accessible applications
- 2-1/8" (54 mm) trapway
- 3" (76 mm) flush valve
- Chrome trip lever supplied
- Includes EZ-Install tools and two color-matched bolt caps
- 10-year warranty
- Design coordinates with Town Square® S suite of fixtures and faucets

Nominal Dimensions:

29-3/4 in x 16-5/8 in x 31 in (755 mm x 422 mm x 787 mm)



Description	Net Wt	SKU	Color	List Price
Town Square® S Two-Piece 1.28 gpf/4.8 Lpf Chair Height Elongated Toilet Less Seat		2917228.020	White	641

Separate Components:

Town Square® S Chair Height Elongated Bowl	60 lb 27.4 kg	3271101.020	White	273
Town Square® S 1.28 gpf/4.8 Lpf 12-Inch Rough Tank	28 lb 12.9 kg	4216228.020	White	368
Town Square® S 12-Inch Rough Toilet Tank Cover	9 lb 4.3 kg	735219-400.020	White	114
Left-Hand Trip Lever	0 lb 0.3 kg	▷7381105-0020A	Polished Chrome	44
		▷7381105-0130A	Polished Nickel	58
		▷7381105-2240A	Oil Rubbed Bronze	109
		▷7381105-2780A	Legacy Bronze	72
		▷7381105-2950A	Brushed Nickel	63

Optional Components:

Traditional Slow-Close & Easy Lift-Off Elongated Toilet Seat	6 lb 3.0 kg	5020A65G.020	White	131
--	----------------	--------------	-------	-----

▷ Parts Program (Non-Premier)

ADA when installed with provided seat, top of seat is 17" to 19" (432 to 483 mm) from the finished floor.

Meets all ANSI/ASME Low Consumption, Water Conservation Requirements.

High Efficiency (1.28 gpf/4.8 Lpf) Toilet



Triangle Cadet® PRO Two-Piece 1.28 gpf/4.8 Lpf Chair Height Elongated Toilet

- Combination bowl and tank, less seat
- Provides corner toilet installation solution
- High efficiency, ultra-low consumption (1.28 gpf/4.8 Lpf), utilizes 20% less water
- Meets EPA WaterSense® criteria
- PowerWash® rim helps clean bowl with each flush
- Metal trip lever
- Metal shank fill valve
- Includes EZ-Install Tools
- EverClean® Antimicrobial Surface
- 16-1/2" (419 mm) rim height for accessible application
- 12" (305 mm) rough-in
- 2-1/8" (54 mm) fully glazed trapway
- 9" x 8" (229 x 203 mm) water surface area
- 3" (76 mm) flush valve
- Color-matched trip lever
- Five-year warranty

Nominal Dimensions:

35-3/16 in x 19-3/8 in x 32-1/16 in (893 mm x 492 mm x 814 mm)



Description	Net Wt	SKU	Color	List Price
Triangle Cadet® PRO Two-Piece 1.28 gpf/4.8 Lpf Chair Height Elongated Toilet		216AD104.020	White	550
Separate Components:				
Cadet® PRO Chair Height Elongated Toilet Bowl Only	55 lb 25.0 kg	3517A101.020	White	264
* Triangle Cadet® PRO 1.28 gpf /4.8 Lpf Triangle Tank	37 lb 16.8 kg	4189D104.020	White	286
* Triangle Cadet® PRO 12-Inch Rough Toilet Tank Cover	7 lb 3.3 kg	735143-400.020	White	117
Left-Hand Trip Lever	0 lb 0.0 kg	▷7381297-200.0200A	White	17
Optional Components:				
Cardiff™ Slow-Close Elongated Toilet Seat	3 lb 1.5 kg	5257A65MT.020	White	71

▷ Parts Program (Non-Premier)

* Tank and tank cover only are Premier

Other seat options

ADA when installed with provided seat, top of seat is 17" to 19" (432 to 483 mm) from the finished floor.

Meets all ANSI/ASME Low Consumption, Water Conservation Requirements.

High Efficiency (1.28 gpf/4.8 Lpf) Toilet



Triangle Cadet® PRO Two-Piece 1.28 gpf/4.8 Lpf Chair Height Round Front Toilet

- Combination bowl and tank, less seat
- Provides corner toilet installation solution
- High efficiency, ultra-low consumption (1.28 gpf/4.8 Lpf), utilizes 20% less water
- Meets EPA WaterSense® criteria
- PowerWash® rim helps clean bowl with each flush
- Metal trip lever
- Metal shank fill valve
- Includes EZ-Install Tools
- EverClean® Antimicrobial Surface
- 16-1/2" (419 mm) rim height for accessible application
- 12" (305 mm) rough-in
- 2-1/8" (54 mm) fully glazed trapway
- 9" x 8" (229 x 203 mm) water surface area
- 3" (76 mm) flush valve
- Color-matched trip lever
- Five-year warranty

Nominal Dimensions:

33-3/16 in x 19-3/8 in x 32-1/16 in (842 mm x 492 mm x 814 mm)



Description	Net Wt	SKU	Color	List Price
Triangle Cadet® PRO Two-Piece 1.28 gpf/4.8 Lpf Chair Height Round Front Toilet		216BD104.020	White	533

Separate Components:

Cadet® PRO Chair Height Round Front Bowl	52 lb 23.9 kg	3517B101.020	White	247
* Triangle Cadet® PRO 1.28 gpf /4.8 Lpf Triangle Tank	37 lb 16.8 kg	4189D104.020	White	286
* Triangle Cadet® PRO 12-Inch Rough Toilet Tank Cover	7 lb 3.3 kg	735143-400.020	White	117
Left-Hand Trip Lever	0 lb 0.0 kg	▷7381297-200.0200A	White	17

Optional Components:

Cardiff™ Slow-Close Round Front Toilet Seat	3 lb 1.4 kg	5259B65MT.020	White	65
---	----------------	---------------	-------	----

▷ Parts Program (Non-Premier)

* Tank and tank cover only are Premier
Other seat options

ADA when installed with provided seat, top of seat is 17" to 19" (432 to 483 mm) from the finished floor.
Meets all ANSI/ASME Low Consumption, Water Conservation Requirements.

Ultra-High Efficiency (1.0 gpf/3.8 Lpf) Toilets



VorMax® Two-Piece 1.0 gpf/3.8 Lpf Chair Height Elongated Toilet Less Seat

- Two patented flush valves and maximum rinsing power for the cleanest flush*
- Combination bowl and tank, less seat
- 12" (305 mm) rough-in
- Chair Height elongated siphon action bowl
- Ultra-high efficiency toilet (UHET) 1.0 gpf/3.8 Lpf
- Meets EPA WaterSense® and MaP Premium criteria
- EverClean® Antimicrobial Surface
- Transitional styling
- CleanCurve® rim eliminates rim area where dirt and build-up hide
- 16-½" (419 mm) rim height for accessible applications
- 2-1/16" (52 mm) trapway
- Dual injection flush valves
- Chrome trip lever
- Two color-matched bolt caps
- 10-year warranty



Nominal Dimensions:

30-3/16 in x 17-7/8 in x 32-1/4 in (766 mm x 454 mm x 819 mm)

Description	Net Wt	SKU	Color	List Price
VorMax® Two-Piece 1.0 gpf/3.8 Lpf Chair Height Elongated Toilet Less Seat		238AA114.020	White	504

Separate Components:

VorMax® Chair Height Elongated Bowl	57 lb 25.9 kg	3385A101.020	White	262
VorMax® 1.0 gpf/3.8 Lpf 12-Inch Rough Tank Only	36 lb 16.5 kg	4385A114.020	White	242
VorMax® 12-Inch Rough Toilet Tank Cover	8 lb 3.6 kg	735216-400.020	White	111
Left-Hand Trip Lever	0 lb 0.1 kg	▷7381740-200.0020A	Polished Chrome	73
		▷7381740-200.0130A	Polished Nickel	80
		▷7381740-200.2780A	Legacy Bronze	107
		▷7381740-200.2950A	Brushed Nickel	86

Optional Components:

Contemporary Slow-Close & Easy Lift-Off Elongated Toilet Seat for VorMax® CleanCurve® Style Rims	3 lb 1.7 kg	5055A65C.020	White	108
--	----------------	--------------	-------	-----

Two-Piece Toilets

▷ Parts Program (Non-Premier)

ADA when installed with provided seat, top of seat is 17" to 19" (432 to 483 mm) from the finished floor.

Meets all ANSI/ASME Low Consumption, Water Conservation Requirements.

*Compared to American Standard Champion toilets.

High Efficiency (1.28 gpf/4.8 Lpf) Toilet



VorMax® Two-Piece 1.28 gpf/4.8 Lpf Chair Height Elongated Toilet Less Seat

- Two patented flush valves and maximum rinsing power for the cleanest flush*
- Combination bowl and tank, less seat
- 12" (305 mm) rough-in
- Chair Height elongated siphon action bowl
- High efficiency toilet (HET) 1.28 gpf/4.8 Lpf
- Meets EPA WaterSense®
- EverClean® Antimicrobial Surface
- Transitional styling
- CleanCurve® rim eliminates rim area where dirt and build-up hide
- 16-1/2" (419 mm) rim height for accessible applications
- 2-1/16" (52 mm) trapway
- Dual injection flush valves
- Chrome trip lever
- Two color-matched bolt caps
- 10-year warranty
- Meets MaP Premium criteria

Nominal Dimensions:

30-3/16 in x 17-7/8 in x 32-1/4 in (766 mm x 454 mm x 819 mm)



Description	Net Wt	SKU	Color	List Price
VorMax® Two-Piece 1.28 gpf/4.8 Lpf Chair Height Elongated Toilet Less Seat		238AA104.020	White	504

Separate Components:

VorMax® Chair Height Elongated Bowl	57 lb 25.9 kg	3385A101.020	White	262
VorMax® 1.28 gpf/4.8 Lpf 12-Inch Rough Tank	36 lb 16.7 kg	4385A104.020	White	242
VorMax® 12-Inch Rough Toilet Tank Cover	8 lb 3.6 kg	735216-400.020	White	111
Left-Hand Trip Lever	0 lb 0.1 kg	▷7381740-200.0020A	Polished Chrome	73
		▷7381740-200.0130A	Polished Nickel	80
		▷7381740-200.2780A	Legacy Bronze	107
		▷7381740-200.2950A	Brushed Nickel	86

Optional Components:

Contemporary Slow-Close & Easy Lift-Off Elongated Toilet Seat for VorMax® CleanCurve® Style Rims	3 lb 1.7 kg	5055A65C.020	White	108
--	----------------	--------------	-------	-----

▷ Parts Program (Non-Premier)

ADA when installed with provided seat, top of seat is 17" to 19" (432 to 483 mm) from the finished floor.

Meets all ANSI/ASME Low Consumption, Water Conservation Requirements.

*Compared to American Standard Champion toilets.



Cadet® Three-Hole Deck Mount Fitting Bidet Bowl

- Integral overflow
- Two color-matched bolt caps
- For through-the-floor outlet
- Design-matched to Cadet® and Champion® toilets
- For deck mount fitting only: flushing rim and vertical cleansing spray
- Suggested bidet fitting (not included): Serin® 2064401.002

Nominal Dimensions:

25-3/4 in x 15-3/8 in x 14-7/8 in (654 mm x 390 mm x 377 mm)



Description	Net Wt	SKU	Color	List Price
Cadet® Three-Hole Deck Mount Fitting Bidet Bowl	42 lb 19.1 kg	5023100.020	White	665

Optional Components:

Serin® Fixture-Mounted Bidet Fitting	8 lb 4.1 kg	2064401.002	Polished Chrome	766
--------------------------------------	----------------	-------------	-----------------	-----



Cadet® Monoblock Deck Mount Fitting Bidet Bowl

- Integral overflow
- Two color-matched bolt caps
- For through-the-floor outlet
- Design-matched to Cadet® and Champion® toilets

Nominal Dimensions:

25-3/4 in x 15-3/8 in x 14-7/8 in (654 mm x 390 mm x 377 mm)



Description	Net Wt	SKU	Color	List Price
Cadet® Monoblock Deck Mount Fitting Bidet Bowl	42 lb 19.1 kg	5023111.020	White	276

Optional Components:

Serin® Monoblock Bidet Fitting	5 lb 2.3 kg	2064011.002	Polished Chrome	363
--------------------------------	----------------	-------------	-----------------	-----

Dual Flush (1.32 – 0.92 gpf/4.9 – 3.4 Lpf) Toilet



Advanced Clean® 100 1.32 gpf/4.9 Lpf and 0.92 gpf/3.4 Lpf SpaLet® Bidet Toilet

- Independent self-cleaning dual nozzles for effective front and back cleansing
- Automatic open/slow-close lid and seat for touchless experience
- Warm air dryer with three adjustable temperature reduces the need for toilet paper
- Adjustable, automatic flush setting (off, 2, 6, 10, 15 second delay options)
- Heated seat with five adjustable temperature for added comfort
- Adjustable water controls: water pressure of six levels plus a massage, oscillation and mild spray feature
- Adjustable water temperature of five temperature levels
- Deodorizer: Air Shield, Room Refresh and Blue Light technology cleans the air in and around the bowl
- Soft night light guides you at night
- External manual flush button
- Nozzle Shutter keeps nozzles clean and hygienic
- Eco-friendly one-touch power save mode
- Intuitive remote control for easy operation
- In-line easy to access water strainer
- ADA compliant
- WaterSense® dual flush 1.32 - 0.92 gpf /4.9 - 3.4 Lpf
- Power Stream Flush: Double vortex flush with siphon jet
- Three-year warranty

Nominal Dimensions:

25-1/6 in x 14-3/4 in x 20-5/8 in (639 mm x 374 mm x 523 mm)



Description	Net Wt	SKU	Color	List Price
Advanced Clean® 100 1.32 gpf/4.9 Lpf and 0.92 gpf/3.4 Lpf SpaLet® Bidet Toilet		297AA204-291	Alabaster White	4,568

Separate Components:

Advanced Clean 100 SpaLet Bidet Toilet Bowl	46 lb 21.1 kg	3970A101-291	Alabaster White	1,112
Advanced Clean 100 SpaLet Bidet Toilet Seat Unit	15 lb 7.1 kg	8017A60GRC-291	Alabaster White	3,456



Advanced Clean® 1.0 Electric SpaLet® Bidet Seat With Side Panel Operation

- Independent self-cleaning dual nozzles for effective front and back cleansing
- Adjustable heated seat: three pre-set and two additional temperature levels for added comfort
- Adjustable water controls: water pressure of three pre-set and two additional levels plus a massage and oscillation spray feature
- Adjustable water temperature of three pre-set and two additional temperature levels
- Active charcoal deodorizer reduces odors in the bowl
- “No Slam” slow-close seat and lid for user convenience
- One-push removable seat for easier cleaning of the seat and bowl
- Nozzle Shutter keeps nozzles clean and hygienic
- Eco-friendly one-touch power save mode
- Intuitive side panel remote control for easy operation
- 6-13/16” (173 mm) seat height
- Includes mounting hardware, water supply hose and seat
- Fits most conventional elongated toilets
- Removable nozzle tips for additional cleaning

Nominal Dimensions:

21-1/8 in x 18-3/8 in x 6-13/16 in (536 mm x 466 mm x 173 mm)



Description	Net Wt	SKU	Color	List Price
Advanced Clean® 1.0 Electric SpaLet® Bidet Seat With Side Panel Operation	9 lb 4.1 kg	8013A80GPC-020	White	562

Separate Components:

Mounting Kit Advanced Clean Bidet Seats	0 lb 0.2 kg	▷760241-200.0070A	No Finish	32
---	----------------	-------------------	-----------	----



Advanced Clean® 2.0 Electric SpaLet® Bidet Seat With Remote Operation

- Independent self-cleaning dual nozzles for effective front and back cleansing
- Heated seat with five adjustable temperature for added comfort
- Adjustable water controls: water pressure of six levels plus a massage and oscillation spray feature
- Adjustable water temperature of five temperature levels
- Active charcoal deodorizer reduces odors in the bowl
- “No Slam” slow-close seat and lid for user convenience
- One-push removable seat for easier cleaning of the seat and bowl
- Nozzle shutter keeps nozzles clean and hygienic
- Eco-friendly one-touch power save mode
- Intuitive remote control for easy operation
- 6-13/16” (173 mm) seat height
- Includes mounting hardware, water supply hose and seat
- Fits most conventional elongated toilets
- Removable nozzle tips for additional cleaning

Nominal Dimensions:

21-1/8 in x 17-3/16 in x 6-13/16 in (536 mm x 436 mm x 173 mm)



Description	Net Wt	SKU	Color	List Price
Advanced Clean® 2.0 Electric SpaLet® Bidet Seat With Remote Operation	9 lb 4.4 kg	8012A80GRC-020	White	680

Separate Components:

Mounting Kit Advanced Clean Bidet Seats	0 lb 0.2 kg	▷760241-200.0070A	No Finish	32
---	----------------	-------------------	-----------	----

▷ Parts Program (Non-Premier)



Advanced Clean® 2.5 Electric SpaLet® Bidet Seat With Remote Operation

- Independent self-cleaning dual nozzles for effective front and back cleansing
- Instant heating ensures constant availability of warm water
- Warm air dryer with three adjustable temperature reduces the need for toilet paper
- Heated seat with five adjustable temperature for added comfort
- Adjustable water controls: water pressure of six levels plus a massage and oscillation spray feature
- Adjustable water temperature of five temperature levels
- Active charcoal deodorizer reduces odors in the bowl
- Soft night light guides you at night
- "No Slam" slow-close seat and lid for user convenience
- One-push removable seat for easier cleaning of the seat and bowl
- Nozzle Shutter keeps nozzles clean and hygienic
- Eco-friendly one-touch power save mode
- Intuitive remote control for easy operation
- Slim 5-1/2" (140 mm) seat height
- Includes mounting hardware, water supply hose and seat
- Fits most conventional elongated toilets
- Removable nozzle tips for additional cleaning

Nominal Dimensions:

21-1/8 in x 17 in x 5-1/2 in (536 mm x 431 mm x 139 mm)



Description	Net Wt	SKU	Color	List Price
Advanced Clean® 2.5 Electric SpaLet® Bidet Seat With Remote Operation	16 lb 7.6 kg	8012A60GRC-020	White	1,096

Separate Components:

Mounting Kit Advanced Clean Bidet Seats	0 lb 0.2 kg	▶760241-200.0070A	No Finish	32
---	----------------	-------------------	-----------	----



Advanced Clean® 3.0 Electric SpaLet® Bidet Seat With Remote Operation

- Independent self-cleaning dual nozzles for effective front and back cleansing
- Instant heating ensures constant availability of warm water
- Warm air dryer with three adjustable temperature reduces the need for toilet paper
- Heated seat with five adjustable temperature for added comfort
- Adjustable water controls: water pressure of six levels plus a massage, oscillation and mild spray feature
- Adjustable water temperature of five temperature levels
- Air Shield Deodorizer deodorizes odor in the bowl
- "No Slam" slow-close seat and lid for user
- Pre-mist wets the bowl surface to reduce waste build-up
- One-push removable seat for easier cleaning of the seat and bowl
- Nozzle Shutter keeps nozzles clean and hygienic
- Eco-friendly one-touch power save mode
- Intuitive remote control for easy operation
- Ultra slim 4-1/16" (104 mm) seat height
- Includes mounting hardware, water supply hose and seat
- Fits most conventional elongated toilets
- Removable nozzle tips for additional cleaning

Nominal Dimensions:

21-5/16 in x 16-1/4 in x 4-1/16 in (541 mm x 412 mm x 103 mm)



Description	Net Wt	SKU	Color	List Price
Advanced Clean® 3.0 Electric SpaLet® Bidet Seat With Remote Operation	11 lb 5.3 kg	8018A60GRC-020	White	1,818

Separate Components:

Mounting Kit	0 lb 0.4 kg	▶760287-401.0070A	No Finish	138
--------------	----------------	-------------------	-----------	-----

▶ Parts Program (Non-Premier)



AquaWash® Slim Non-Electric SpaLet® Bidet Seat With Manual Operation

- Non-electric bidet feature with adjustable spray volume
- Independent self-cleaning dual nozzles for effective front and back cleansing
- Slim 2-3/16 (55 mm) seat height
- “No Slam” slow-close seat and lid for user convenience
- One-push removable seat for easier cleaning of the seat and bowl
- “Nozzle Shutter” keeps nozzles clean and hygienic
- Removable nozzle tips for additional cleaning
- Ergonomically designed handle for intuitive operation
- Includes mounting hardware, water supply hose and seat
- Fits most conventional elongated toilets

Nominal Dimensions:

19-5/16 in x 14-9/16 in x 2-3/16 in (490 mm x 369 mm x 55 mm)



Description	Net Wt	SKU	Color	List Price
AquaWash® Slim Non-Electric SpaLet® Bidet Seat With Manual Operation	4 lb 2.0 kg	8033A65G.020	White	229

Separate Components:

AquaWash® Slim Seat Mounting Kit	0 lb 0.1 kg	▷760-06-0046.0070A	No Finish	17
----------------------------------	----------------	--------------------	-----------	----



AquaWash® 1.0 Non-Electric SpaLet® Bidet Seat With Manual Operation

- Non-electric bidet feature with adjustable spray volume
- Independent self-cleaning dual nozzles for effective front and back cleansing
- “No Slam” slow-close seat and lid for user convenience
- One-push removable seat for easier cleaning of the seat and bowl
- Manual side lever: easy to operate
- 2-7/16” (62 mm) seat height
- Seamless telescoping lid design to conceal the seat ring
- Includes mounting hardware, water supply hose and seat
- Fits most conventional elongated toilets
- Removable nozzle tips for additional cleaning

Nominal Dimensions:

19-11/16 in x 14-9/16 in x 2-7/16 in (500 mm x 369 mm x 61 mm)



Description	Net Wt	SKU	Color	List Price
AquaWash® 1.0 Non-Electric SpaLet® Bidet Seat With Manual Operation	4 lb 2.0 kg	5900A05GT.020	White	146

Separate Components:

Mounting Kit Aquawash Spalet Seats	0 lb 0.1 kg	▷760242-200.0070A	No Finish	32
------------------------------------	----------------	-------------------	-----------	----



AquaWash® 2.0 Electric SpaLet® Bidet Seat With Manual Operation

- Independent self-cleaning dual nozzles for effective front and back cleansing
- Instant heating ensures constant availability of warm water
- Heated seat with two adjustable temperature for added comfort
- Adjustable water temperature of two temperature levels
- Soft night light guides you at night
- “No Slam” slow-close seat and lid for user convenience
- One-push removable seat for easier cleaning of the seat and bowl
- Manual side lever: easy to operate
- Ultra low 3-3/4” (95 mm) seat height
- Seamless telescoping lid design to conceal the seat ring
- Includes mounting hardware, water supply hose and seat
- Fits most conventional elongated toilets
- Removable nozzle tips for additional cleaning

Nominal Dimensions:

20 in x 14-3/4 in x 3-3/4 in (508 mm x 374 mm x 95 mm)



Description	Net Wt	SKU	Color	List Price
AquaWash® 2.0 Electric SpaLet® Bidet Seat With Manual Operation	7 lb 3.3 kg	8019A60GPC.020	White	508

Separate Components:

Mounting Kit Aquawash Spalet Seats	0 lb 0.1 kg	▷760242-200.0070A	No Finish	32
------------------------------------	----------------	-------------------	-----------	----

▷ Parts Program (Non-Premier)

Toilet Seats



Cadet® 3 Slow-Close Elongated Toilet Seat

- “No Slam” slow-close seat and lid for user convenience
- EverClean® Antimicrobial Surface
- Sanitary lift tab allows user to raise the seat with ease
- Fits most conventional elongated toilets
- Bottom mounting hardware included
- Made from Polypropylene Plastic
- Traditional design

Nominal Dimensions:

18-13/16 in x 14-7/16 in x 2-3/16 in (477 mm x 366 mm x 55 mm)

Description	Net Wt	SKU	Color	List Price
Cadet® 3 Slow-Close Elongated Toilet Seat	4 lb 2.0 kg	5350110.020	White	81
		5350110.021	Bone	110
		5350110.222	Linen	110

Separate Components:

Bottom Mount Seat Mounting Kit	0 lb 0.0 kg	▷760087-0070A	No Finish	9
--------------------------------	----------------	---------------	-----------	---

Toilet Seats



Cadet® 3 Slow-Close Round Front Toilet Seat

- “No Slam” slow-close seat & lid for user convenience
- EverClean® Antimicrobial Surface
- Sanitary lift tab allows user to raise the seat with ease
- Fits most conventional round front toilets
- Bottom mounting hardware included
- Made from Polypropylene Plastic
- Traditional design

Nominal Dimensions:

16-11/16 in x 14-3/16 in x 2-1/4 in (423 mm x 360 mm x 57 mm)

Description	Net Wt	SKU	Color	List Price
Cadet® 3 Slow-Close Round Front Toilet Seat	3 lb 1.7 kg	5345110.020	White	79
		5345110.021	Bone	104
		5345110.222	Linen	104

Separate Components:

Bottom Mount Seat Mounting Kit	0 lb 0.0 kg	▷760087-0070A	No Finish	9
--------------------------------	----------------	---------------	-----------	---



Cardiff™ Slow-Close Elongated Toilet Seat

- “No Slam” slow-close seat and lid for user convenience
- EverClean® Antimicrobial Surface
- Fits most conventional elongated toilets
- Bottom mounting hardware with Quick connect nut included to expedite installation
- Made from Polypropylene Plastic

Nominal Dimensions:

18-11/16 in x 13-7/8 in x 2-1/4 in (474 mm x 352 mm x 57 mm)

Description	Net Wt	SKU	Color	List Price
Cardiff™ Slow-Close Elongated Toilet Seat	3 lb 1.5 kg	5257A65MT.020	White	71
		5257A65MT.021	Bone	78
		5257A65MT.222	Linen	78

Separate Components:

Bottom Mount Seat Mounting Kit	0 lb 0.0 kg	▷760219-100.0070A	No Finish	6
--------------------------------	----------------	-------------------	-----------	---

▷ Parts Program (Non-Premier)

Toilet Seats



Cardiff™ Slow-Close Round Front Toilet Seat

- “No Slam” slow-close seat & lid for user convenience
- EverClean® Antimicrobial Surface
- Fits most conventional round front toilets
- Bottom mounting hardware with Quick connect nut included to expedite installation
- Made from Polypropylene Plastic

Nominal Dimensions:

16-5/8 in x 14-3/16 in x 2-1/4 in (422 mm x 360 mm x 57 mm)

Description	Net Wt	SKU	Color	List Price
Cardiff™ Slow-Close Round Front Toilet Seat	3 lb	5259B65MT.020	White	65
	1.4 kg	5259B65MT.021	Bone	71
		5259B65MT.222	Linen	71

Separate Components:

Bottom Mount Seat Mounting Kit	0 lb 0.0 kg	▷760219-100.0070A	No Finish	6
--------------------------------	----------------	-------------------	-----------	---



Champion® Slow-Close & Easy Lift-Off Elongated Toilet Seat

- “No Slam” slow-close seat and lid for user convenience
- Lift to release Easy Clean hinge for easier cleaning of the seat & bowl – No Tools Required
- EverClean® Antimicrobial Surface
- Fits most conventional elongated toilets
- Bottom mounting hardware included
- Made from Polypropylene Plastic
- Attractive design coordinates with popular bathroom decor

Nominal Dimensions:

18-11/16 in x 14-1/16 in x 2-5/16 in (474 mm x 357 mm x 58 mm)

Description	Net Wt	SKU	Color	List Price
Champion® Slow-Close & Easy Lift-Off Elongated Toilet Seat	3 lb	5321A65CT.020	White	98
	1.6 kg	5321A65CT.021	Bone	123
		5321A65CT.222	Linen	123

Separate Components:

Bottom Mount Seat Mounting Kit	0 lb 0.0 kg	▷760219-100.0070A	No Finish	6
--------------------------------	----------------	-------------------	-----------	---



Champion® Slow-Close & Easy Lift-Off Round Front Toilet Seat

- “No Slam” slow-close seat & lid for user convenience
- Lift to release Easy Clean hinge for easier cleaning of the seat & bowl – No Tools Required
- EverClean® Antimicrobial Surface
- Fits most conventional round front toilets
- Bottom mounting hardware included
- Made from Polypropylene Plastic
- Attractive design coordinates with popular bathroom decor

Nominal Dimensions:

16-13/16 in x 14-5/16 in x 2-5/16 in (427 mm x 363 mm x 58 mm)

Description	Net Wt	SKU	Color	List Price
Champion® Slow-Close & Easy Lift-Off Round Front Toilet Seat	3 lb	5320B65CT.020	White	83
	1.4 kg	5320B65CT.021	Bone	110
		5320B65CT.222	Linen	110

Separate Components:

Bottom Mount Seat Mounting Kit	0 lb 0.0 kg	▷760219-100.0070A	No Finish	6
--------------------------------	----------------	-------------------	-----------	---

▷ Parts Program (Non-Premier)

Toilet Seats



Contemporary Slow-Close & Easy Lift-Off Elongated Toilet Seat for VorMax® CleanCurve® Style Rims

- “No Slam” slow-close seat and lid for user convenience
- Lift to release Easy Clean hinge for easier cleaning of the seat & bowl – No Tools Required
- Ever-Tite® locking hinge system, engineered to reduce the seat from shifting side to side
- EverClean® Antimicrobial Surface
- Sanitary lift tab allows user to raise the seat with ease
- Fits elongated VorMax® CleanCurve® style rim toilets
- Unique bumpers designed for added stability to reduce movement of the seat
- Bottom mounting hardware included
- Made from Polypropylene Plastic
- Easy Close, Easy Lift, Easy Clean

Nominal Dimensions:

18-3/16 in x 14-3/4 in x 2 in (461 mm x 374 mm x 50 mm)

Description	Net Wt	SKU	Color	List Price
Contemporary Slow-Close & Easy Lift-Off Elongated Toilet Seat for VorMax® CleanCurve® Style Rims	3 lb	5055A65C.020	White	108
	1.7 kg	5055A65C.021	Bone	120
		5055A65C.222	Linen	141

Separate Components:

Seat Mounting Kit	0 lb	▷760218-101.0210A	Bone	8
	0.1 kg	▷760218-101.2220A	Linen	8

Contemporary Slow-Close & Easy Lift-Off Elongated Toilet Seat

- “No Slam” slow-close seat and lid for user convenience
- Lift to release Easy Clean hinge for easier cleaning of the seat & bowl – No Tools Required
- Ever-Tite® locking hinge system, engineered to reduce the seat from shifting side to side
- EverClean® Antimicrobial Surface
- Sanitary lift tab allows user to raise the seat with ease
- Fits most conventional elongated toilets
- Flat bumpers designed for universal fit
- Bottom mounting hardware included
- Made from Polypropylene Plastic
- Easy Close, Easy Lift, Easy Clean

Nominal Dimensions:

18-3/16 in x 14-3/4 in x 2 in (461 mm x 374 mm x 50 mm)

Description	Net Wt	SKU	Color	List Price
Contemporary Slow-Close & Easy Lift-Off Elongated Toilet Seat	3 lb	5055A65PT.020	White	107
	1.7 kg	5055A65PT.021	Bone	114
		5055A65PT.222	Linen	114

Separate Components:

Seat Mounting Kit	0 lb	▷760218-101.0210A	Bone	8
	0.1 kg	▷760218-101.2220A	Linen	8

Toilet Seats



Contemporary Slow-Close & Easy Lift-Off Round Front Toilet Seat

- “No Slam” slow-close seat & lid for user convenience
- Lift to release Easy Clean hinge for easier cleaning of the seat & bowl – No Tools Required
- Ever-Tite® locking hinge system, engineered to reduce the seat from shifting side to side
- EverClean® Antimicrobial Surface
- Sanitary lift tab allows user to raise the seat with ease
- Fits most conventional round front toilets
- Flat bumpers designed for universal fit
- Bottom mounting hardware included
- Made from Polypropylene Plastic
- Easy Close, Easy Lift, Easy Clean

Nominal Dimensions:

16-15/16 in x 14-3/4 in x 1-15/16 in (430 mm x 374 mm x 49 mm)

Description	Net Wt	SKU	Color	List Price
Contemporary Slow-Close & Easy Lift-Off Round Front Toilet Seat	3 lb 1.5 kg	5055B65PT.020	White	99
		5055B65PT.021	Bone	107
		5055B65PT.222	Linen	107

Separate Components:

Seat Mounting Kit	0 lb 0.1 kg	▷760218-101.0210A	Bone	8
		▷760218-101.2220A	Linen	8



Laurel Elongated Wood Toilet Seat

- High-gloss, molded wood seat and cover
- Color-matched hinges
- Fits most conventional elongated toilets
- Bottom mounting hardware included

Nominal Dimensions:

18-3/4 in x 13-7/8 in x 2-1/2 in (476 mm x 352 mm x 63 mm)

Description	Net Wt	SKU	Color	List Price
Laurel Elongated Wood Toilet Seat	7 lb 3.2 kg	5311012.020	White	53



Telescoping Slow-Close Easy Lift-Off Elongated Toilet Seat

- “No Slam” slow-close seat and lid for user convenience
- Lift to release Easy Clean hinge for easier cleaning of the seat & bowl – No Tools Required
- Ever-Tite® locking hinge system, engineered to reduce the seat from shifting side to side
- EverClean® Antimicrobial Surface
- Telescoping cover conceals seat when closed
- Top-mounting transitional styled seat with cover can be installed from top of toilet bowl
- Fits most conventional elongated toilets
- Top and bottom mounting hardware included
- Made from Polypropylene Plastic
- Easy Close, Easy Lift, Easy Clean

Nominal Dimensions:

18-9/16 in x 14-5/16 in x 2-1/16 in (471 mm x 363 mm x 52 mm)



Description	Net Wt	SKU	Color	List Price
Telescoping Slow-Close Easy Lift-Off Elongated Toilet Seat	4 lb 2.0 kg	5025A65G.020	White	131
		5025A65G.222	Linen	162

Separate Components:

Seat Mounting Kit	0 lb 0.2 kg	▷760234-100.0200A	White	21
		▷760234-100.2220A	Linen	21

▷ Parts Program (Non-Premier)

Toilet Seats



Telescoping Slow-Close & Easy Lift-Off Round Front Toilet Seat

- “No Slam” slow-close seat & lid for user convenience
- Lift to release Easy Clean hinge for easier cleaning of the seat & bowl – No Tools Required
- Ever-Tite® locking hinge system, engineered to reduce the seat from shifting side to side
- EverClean® Antimicrobial Surface
- Telescoping cover conceals seat when closed
- Top-mounting transitional styled seat with cover can be installed from top of toilet bowl
- Fits most conventional round front toilets
- Top and bottom mounting hardware included
- Made from Polypropylene Plastic
- Easy Close, Easy Lift, Easy Clean

Nominal Dimensions:

16-11/16 in x 14-7/16 in x 2-3/16 in (423 mm x 366 mm x 55 mm)



Description	Net Wt	SKU	Color	List Price
Telescoping Slow-Close & Easy Lift-Off Round Front Toilet Seat	4 lb	5025B65G.020	White	120
	1.9 kg	5025B65G.222	Linen	150

Separate Components:

Seat Mounting Kit	0 lb	▷760234-100.0200A	White	21
	0.2 kg	▷760234-100.2220A	Linen	21



Traditional Slow-Close & Easy Lift-Off Elongated Toilet Seat

- “No Slam” slow-close seat and lid for user convenience
- Lift to release Easy Clean hinge for easier cleaning of the seat & bowl – No Tools Required
- Ever-Tite® locking hinge system, engineered to reduce the seat from shifting side to side
- EverClean® Antimicrobial Surface
- Top-mounting traditional styled seat with cover can be installed from top of toilet bowl
- Fits most conventional elongated toilets
- Top and bottom mounting hardware included
- Made from Polypropylene Plastic
- Easy Close, Easy Lift, Easy Clean

Nominal Dimensions:

18-9/16 in x 14-1/8 in x 2-1/4 in (471 mm x 358 mm x 57 mm)



Description	Net Wt	SKU	Color	List Price
Traditional Slow-Close & Easy Lift-Off Elongated Toilet Seat	6 lb	5020A65G.020	White	131
	3.0 kg	5020A65G.222	Linen	162

Separate Components:

Seat Mounting Kit	0 lb	▷760234-100.0200A	White	21
	0.2 kg	▷760234-100.2220A	Linen	21



Traditional Slow-Close & Easy Lift-Off Round Front Toilet Seat

- “No Slam” slow-close seat & lid for user convenience
- Lift to release Easy Clean hinge for easier cleaning of the seat & bowl – No Tools Required
- Ever-Tite® locking hinge system, engineered to reduce the seat from shifting side to side
- EverClean® Antimicrobial Surface
- Top-mounting traditional styled seat with cover can be installed from top of toilet bowl
- Fits most conventional round front toilets
- Top and bottom mounting hardware included
- Made from Polypropylene Plastic
- Easy Close, Easy Lift, Easy Clean

Nominal Dimensions:

16-11/16 in x 14-1/8 in x 2-5/16 in (423 mm x 358 mm x 58 mm)



Description	Net Wt	SKU	Color	List Price
Traditional Slow-Close & Easy Lift-Off Round Front Toilet Seat	4 lb	5020B65G.020	White	120
	2.1 kg	5020B65G.222	Linen	150

Separate Components:

Seat Mounting Kit	0 lb	▷760234-100.0200A	White	21
	0.2 kg	▷760234-100.2220A	Linen	21

▷ Parts Program (Non-Premier)

Toilet Seats



Transitional Slow-Close Elongated Toilet Seat

- “No Slam” slow-close seat & lid for user convenience
- Fits most conventional elongated toilets
- Bottom mounting hardware included
- Made from Polypropylene Plastic
- Transitional design

Nominal Dimensions:

18-5/8 in x 14-3/16 in x 1-5/8 in (473 mm x 360 mm x 41 mm)



Description	Net Wt	SKU	Color	List Price
Transitional Slow-Close Elongated Toilet Seat	2 lb	5503A00B.020	White	57
	1.3 kg	5503A00B.021	Bone	53
		5503A00B.222	Linen	57

Separate Components:

Bottom Mount Seat Mounting Kit	0 lb 0.0 kg	▷760225-100.0070A	No Finish	6
--------------------------------	----------------	-------------------	-----------	---



Transitional Slow-Close Round-Front Toilet Seat

- “No Slam” slow-close seat & lid for user convenience
- Fits most conventional round front toilets
- Bottom mounting hardware included
- Made from Polypropylene Plastic
- Transitional design

Nominal Dimensions:

16-5/8 in x 14-3/16 in x 1-5/8 in (422 mm x 360 mm x 41 mm)



Description	Net Wt	SKU	Color	List Price
Transitional Slow-Close Round-Front Toilet Seat	2 lb 1.2 kg	5503B00B.020	White	51

Separate Components:

Bottom Mount Seat Mounting Kit	0 lb 0.0 kg	▷760225-100.0070A	No Finish	6
--------------------------------	----------------	-------------------	-----------	---



Transitional Slow-Close & Easy Lift-Off Elongated Toilet Seat

- “No Slam” slow-close seat and lid for user convenience
- Lift to release Easy Clean hinge for easier cleaning of the seat & bowl – No Tools Required
- Ever-Tite® locking hinge system, engineered to reduce the seat from shifting side to side
- EverClean® Antimicrobial Surface
- Top-mounting transitional styled seat with cover can be installed from top of toilet bowl
- Fits most conventional elongated toilets
- Top and bottom mounting hardware included
- Made from Polypropylene Plastic
- Easy Close, Easy Lift, Easy Clean

Nominal Dimensions:

18-9/16 in x 14-1/8 in x 2-1/8 in (471 mm x 358 mm x 53 mm)



Description	Net Wt	SKU	Color	List Price
Transitional Slow-Close & Easy Lift-Off Elongated Toilet Seat	6 lb	5024A65G.020	White	131
	3.0 kg	5024A65G.222	Linen	162

Separate Components:

Seat Mounting Kit	0 lb 0.2 kg	▷760234-100.0200A	White	21
		▷760234-100.2220A	Linen	21

▷ Parts Program (Non-Premier)

Toilet Seats



Transitional Slow-Close & Easy Lift-Off Round Front Toilet Seat

- “No Slam” slow-close seat & lid for user convenience
- Lift to release Easy Clean hinge for easier cleaning of the seat & bowl – No Tools Required
- Ever-Tite® locking hinge system, engineered to reduce the seat from shifting side to side
- EverClean® Antimicrobial Surface
- Top-mounting transitional styled seat with cover can be installed from top of toilet bowl
- Fits most conventional round front toilets
- Top and bottom mounting hardware included
- Made from Polypropylene Plastic
- Easy Close, Easy Lift, Easy Clean

Nominal Dimensions:

16-11/16 in x 14-1/8 in x 2-3/16 in (423 mm x 358 mm x 55 mm)



Description	Net Wt	SKU	Color	List Price
Transitional Slow-Close & Easy Lift-Off Round Front Toilet Seat	4 lb	5024B65G.020	White	120
	2.1 kg	5024B65G.222	Linen	150

Separate Components:

Seat Mounting Kit	0 lb	▷760234-100.0200A	White	21
	0.2 kg	▷760234-100.2220A	Linen	21

Toilet Trip Levers



Top-of-Tank Actuator, Dual Flush

- Dual flush push button actuator, top mount assembly for Boulevard® one-piece toilet
- ABS plastic button
- Plastic arm
- Specify color when ordering
- Kit consists of dual flush actuator and tightening nuts
- 1-year warranty

Nominal Dimensions:

3-1/4 in x 1-13/16 in x 4-3/16 in (82 mm x 46 mm x 106 mm)

Description	Net Wt	SKU	Color	List Price
Top-of-Tank Actuator, Dual Flush	0 lb 0.1 kg	▷7381203-200.0020A	Polished Chrome	15
		▷7381203-200.2430A	Matte Black	132
		▷7381203-200.2950A	Brushed Nickel	109



Left-Hand Trip Lever

- Left-hand trip lever assembly for Cadet®3
- Plastic lever handle
- Plastic arm
- Specify color when ordering
- Kit consists of handle, nut and arm
- 1-year warranty

Description	Net Wt	SKU	Color	List Price
Left-Hand Trip Lever	0 lb 0.0 kg	▷738903-0020A	Polished Chrome	25
		▷738903-0200A	White	41
		▷738903-2220A	Linen	47
		▷738903-2430A	Matte Black	100
		▷738903-2950A	Brushed Nickel	35



Left-Hand Trip Lever

- Left-hand trip lever assembly for Boulevard® one-piece toilet and Cadet®3 4000.004 and 4000.104 tanks
- Metal lever handle
- Brass arm
- Specify color when ordering
- Kit consists of handle, nut and arm
- 1-year warranty

Description	Net Wt	SKU	Color	List Price
Left-Hand Trip Lever	0 lb 0.3 kg	▷7381064-2240A	Oil Rubbed Bronze	113
		▷7381064-2430A	Matte Black	84
		▷7381064-2950A	Brushed Nickel	67

Toilet Trip Levers



Left-Hand Trip Lever

- Left-hand trip lever for Champion® PRO 4225A tank
- Metal lever handle
- Brass arm
- Specify color when ordering
- Kit consists of handle, nut and arm
- One-year warranty

Nominal Dimensions:

5.3 in x 6.8 in x 3.2 in (134 mm x 172 mm x 81 mm)

Description	Net Wt	SKU	Color	List Price
Left-Hand Trip Lever	0 lb 0.2 kg	▷7381232-200.0020A	Polished Chrome	42
	0 lb 0.1 kg	▷7381232-200.0130A	Polished Nickel	46
	0 lb 0.2 kg	▷7381232-200.0200A	White	52
		▷7381232-200.2240A	Oil Rubbed Bronze	103
	0 lb 0.1 kg	▷7381232-200.2780A	Legacy Bronze	78
	0 lb 0.2 kg	▷7381232-200.2950A	Brushed Nickel	55



Left-Hand Trip Lever

- Left-hand trip lever assembly for Cadet® PRO tanks 4188A and 4188B
- Metal lever handle
- Metal arm
- Specify color when ordering
- Kit consists of handle, nut and arm
- One-year warranty

Nominal Dimensions:

5.7 in x 7.6 in x 2.8 in (144 mm x 193 mm x 71 mm)

Description	Net Wt	SKU	Color	List Price
Left-Hand Trip Lever	0 lb 0.2 kg	▷7381231-200.0020A	Polished Chrome	37
	0 lb 0.1 kg	▷7381231-200.0130A	Polished Nickel	46
	0 lb 0.2 kg	▷7381231-200.0200A	White	45
		▷7381231-200.0990A	Polished Brass	45
		▷7381231-200.2240A	Oil Rubbed Bronze	67
	0 lb 0.1 kg	▷7381231-200.2780A	Legacy Bronze	108
	0 lb 0.0 kg	▷7381231-200.2950A	Brushed Nickel	54

Optional Toilet Tanks



Champion® PRO

Description	Net Wt	SKU	Color	List Price
Champion® PRO 1.6 gpf/6.0 Lpf 12-Inch Rough Tank with TCLD	31 lb 14.1 kg	4225A064.020	White	280
Champion® PRO 1.28 gpf/4.8 Lpf 12-Inch Rough Lined Tank		4225A154.020	White	314
Champion® PRO 1.28 gpf/4.8 Lpf Toilet Tank with Tank Cover Locking Device		4225A164.020	White	280
Champion® PRO 1.28 gpf/4.8 Lpf Toilet Tank with Aquaguard Liner and Tank Cover Locking Device		4225A174.020	White	342



Cadet® PRO

Cadet® PRO 1.6 gpf/6.0 Lpf 12-Inch Rough Lined Tank	27 lb 12.6 kg	4188A054.020	White	231
		4188A054.021	Bone	287
		4188A054.222	Linen	287
Cadet® PRO 1.6 gpf/6.0 Lpf 12-Inch Toilet Tank with Tank Cover Locking Device		4188A064.020	White	202
Cadet® PRO 1.6 gpf/6.0 Lpf 12-Inch Toilet Tank with Tank Cover Locking Device and Right Hand Trip Lever		4188A065.020	White	208
Cadet® PRO 1.6 gpf/6.0 Lpf 12-Inch Toilet Tank with Aquaguard Liner and Tank Cover Locking Device		4188A074.020	White	280
Cadet® PRO 1.28 gpf/4.8 Lpf 12-Inch Rough Lined Tank		4188A154.020	White	231
		4188A154.021	Bone	287
		4188A154.222	Linen	287
Cadet® PRO 1.28 gpf/4.8 Lpf 12-Inch Toilet Tank with Aquaguard Liner and Right Hand Trip Lever		4188A155.020	White	275
Cadet® PRO 1.28 gpf/4.8 Lpf 12-Inch Toilet Tank with Tank Cover Locking Device		4188A164.020	White	202
Cadet® PRO 1.28 gpf/4.8 Lpf 12-Inch Toilet Tank with Tank Cover Locking Device and Right Hand Trip Lever		4188A165.020	White	208
Cadet® PRO 1.28 gpf/4.8 Lpf 12-Inch Toilet Tank with Aquaguard Liner and Tank Cover Locking Device		4188A174.020	White	280
Cadet® PRO 1.28 gpf/4.8 Lpf 12-Inch Rough Right-Hand Trip Lever Tank		4188A105.020	White	157

Notes

Notes

Notes

Notes

Notes

Notes

Notes

Faucet Style Meets Substance

American Standard faucets are engineered to look beautiful and function flawlessly. Our exquisite designs offer innovative conveniences like easy-to-upgrade shower styles, peace-of-mind safety features and simpler-than-ever installation and cleaning.

Superior Engineering Inside and Out

Our ceramic disc valves are maintenance-free, and provide a lifetime of smooth handle control, even in extreme temperature or hard water conditions.

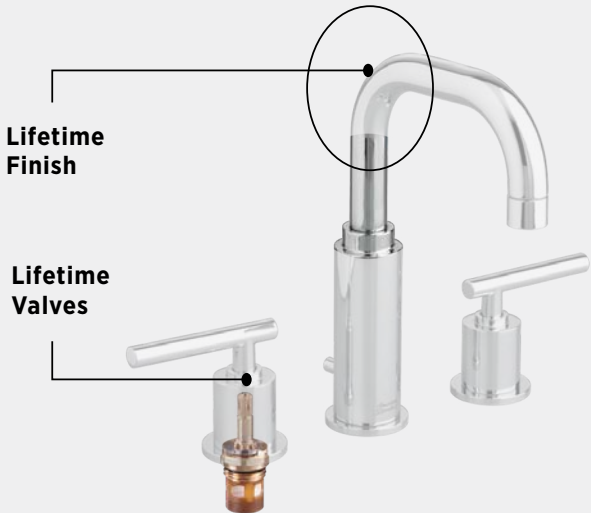

Faucet Lifetime Finishes

American Standard offers a myriad of fine finishes all guaranteed to last a lifetime.*



Matte Black and Legacy Bronze

The rich patina of these popular finishes make a statement in any setting. Meticulously applied for long wear, the smooth, saturated depth of Matte Black and the subtle luster of Legacy Bronze add focal interest and the perfect finishing touch.



*Extended to the original consumer purchaser. See faucet pages for finishes available for each faucet model. Color samples may vary slightly from the actual colors. Not all finishes are available on all products.

Featured NEW Products

American Standard

LIFE.LOVE.HOME

Colony® PRO Touchless Single-Handle Dual Spray Kitchen Faucet



**Cadet® Ovation Two-Piece
1.28 gpf/4.8 Lpf Chair Height Elongated
Toilet With Seat**



**Colony®3 Two-Piece 1.28 gpf/4.8 Lpf
Chair-Height Elongated Toilet**

Icons

Bathroom Faucets

Faucet Style Meets Substance/Lifetime Finishes
Featured NEW Products
Bathroom Faucets Overview
Flash® Bathtub Faucet Overview
Bathroom Faucet Families Overview
WaterSense® Certified Faucets and Showers
Flash® Shower Rough-In Valves
Freestanding Bathtub Faucets

Bathroom Faucets and Trim Kits

Colony® PRO
Crawford™
Delancey®
Edgemere®
Fluent®
Glenmere™
Reliant 3®
Serin®
Studio® S
Town Square® S
Townsend®

Bathroom Accessories

Bathroom Accessories Overview
Bathroom Accessories

Showering Options

Spectra Versa® Retrofit Shower System
Spectra® Shower Collection
Spectra Versa® Shower System
Spectra® Duo 2-in-1 Hand Showers
Fixed Showerheads/Rain Showerheads
Body Side Sprays
Shower Arms
Hand Showers
Slide Bar Kits, Shower System Trim Kit, Hand Shower Kits
Slide Bars
Shower System Accessories
Tub Spouts

Parts

Drains and P-Trap
Lavatory Faucets
Flash® Rough-In Valves
Cartridges and Rough-In Kits

Faucet Modifications

Warranties

Bathroom Faucets

Bathroom Faucets Overview

Our faucets feature:

- Drip Free Ceramic Disc Valves on 100% of our product offering
- Water Efficient Options – WaterSense® certified lavatory faucets and showers
- Lead Free Lavatory Faucets
- Freestanding Bathtub Faucets
- Bathroom Accessories
- Showering Options



Colony® PRO



Crawford™



Delancey®



Edgemere®



Fluent®



Glenmere™



Reliant 3®



Serin®



Studio® S



Town Square® S



Townsend®

Bathroom Faucets

Flash® Bathtub Faucets Overview

- Valve and trim packaged separately
- Install valve prior to trim selection — no trim damage during construction
- Integrated hand shower diverter



Colony® PRO



Delancey®



Edgemere®



Fluent®



Studio® S



































Town Square® S



















Townsend®

Bathroom Faucet Families Overview

Bathroom Faucets

	Colony® PRO	Crawford™	Delancey®	Edgemere®	Fluent®
Widespread					
Monoblock					
Vessel					
2-Handle Centerset					
Bathtub Faucet					
Freestanding Bathtub Faucet					
Bath/Shower Trim					
Shower System Trim					
Accessories					

Bathroom Faucet Families Overview

Glenmere™	Reliant 3®	Serin®	Studio® S	Town Square® S	Townsend®
					
					
					
					
					
					
					
					
					

Bathroom Faucets

WaterSense® Certified Faucets

All American Standard bathroom faucets are WaterSense certified for high performance and water efficiency. Flowing at **1.2 gpm/4.5 L/min**, more efficient than the Environmental Protection Agency's (EPA) strict WaterSense maximum flow rate requirement of **1.5 gpm/5.7 L/min**, all American Standard residential lavatory faucets incorporate pressure-compensating aerators that provide 45% water savings over standard models without sacrificing performance.



This WaterSense label is your confirmation that the product has met the U.S. Environmental Protection Agency (EPA) criteria for exceptional performance while reducing water use by 20% or more.

WaterSense is a voluntary partnership program launched by the U.S. Environmental Protection Agency to designate product and services that conserve water and perform as intended. WaterSense is a registered trade/service mark of the EPA.

Bathroom Faucets

WaterSense® Certified Showers

American Standard offers a variety of WaterSense and CEC certified showering options for high performance and water efficiency. Meeting the Environmental Protection Agency's (EPA) strict maximum flow rate of **2.0 gpm/7.8 L/min**, American Standard's residential showering options provide over 20% water savings versus standard models without sacrificing performance.



This WaterSense label is your confirmation that the product has met the U.S. Environmental Protection Agency (EPA) criteria for exceptional performance while reducing water use by 20% or more.

WaterSense is a voluntary partnership program launched by the U.S. Environmental Protection Agency to designate product and services that conserve water and perform as intended.

WaterSense is a registered trade/service mark of the EPA.

Flash® Shower Rough-in Valves

Designed for Faster Installation

Flat Back

Allows the valve to be mounted flush with the cross brace

Cast DZR Brass Body

Offers strong, durable construction

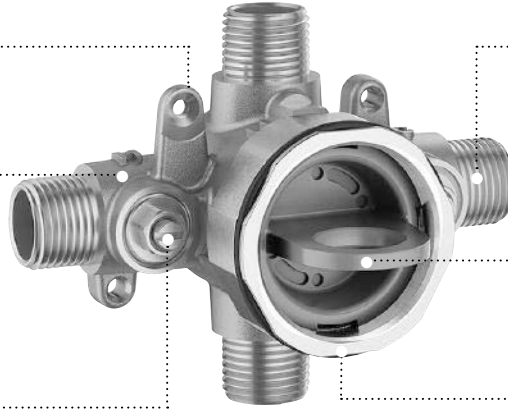

Choice of Connections

Provides fast and easy installation without adaptors, reducing leak points

Flush Plug

Allows flushing and testing of valve prior to installing cartridge

Stainless Steel Retaining Ring with Flats

Secures flush plug/cartridge in place and eliminates need for screws

Straight Screwdriver Stops

Ensures easy servicing at the valve (on applicable models)

Key Features



Flat Back

- Intuitive flat back feature means you'll achieve a secure and solid mount every time using a 2 x 4 cross brace
- Designed to work in tight spaces



Flush Plug







- The flush plug makes flush-testing simple and fast
- Allows for ability to flush hot and cold lines separately or simultaneously



Stainless Steel Retaining Ring with Flats

- Secures test cap and cartridge in place
- Flats make installation and servicing even more convenient
- No screws, no hassles

More Connections to Choose From

Universal Connection	CPVC Connection	PEX Crimp Connection	Cold Expansion PEX Connection	PEX Crimp Elbow Connection	Cold Expansion Elbow PEX Connection	Stub-Out Connection
(Female Sweat/ Male Thread NPT)		(ASTM F1807)	(ASTM F1960)	(ASTM F1807)	(ASTM F1960)	
						
RU101/RU101SS	RU109/RU109SS	RU107/RU107SS	RU108/RU108SS	RU107E/ RU107ESS	RU108E/ RU108ESS	RU102/RU102SS
Works with:	Works with:	Works with:	Works with:	Works with:	Works with:	Works with:
<ul style="list-style-type: none"> • 1/2" Copper Pipe • 1/2" Iron Pipe • 1/2" CPVC Adaptors • 1/2" PEX Adaptors 	<ul style="list-style-type: none"> • Standard CPVC Piping • No additional adaptors needed 	<ul style="list-style-type: none"> • Type PEX A, B and C (Crimp PEX) • No additional adaptors needed 	<ul style="list-style-type: none"> • Type PEX A (Cold Expansion PEX) • No additional adaptors needed 	<ul style="list-style-type: none"> • Type PEX A, B and C (Crimp PEX) • No additional adaptors needed 	<ul style="list-style-type: none"> • Type PEX A (Cold Expansion PEX) • No additional adaptors needed 	<ul style="list-style-type: none"> • 1/2" Press-connect fittings

Flash® Shower Rough-in Valves

One-Piece Pressure Balance Cartridge with Double Ceramic Technology



Ceramic Discs

- Provides leak-free and smooth handle operation over the life of the valve
- Allows for a wider range of motion and more precise fine-tuning of the temperature
- Unaffected by harsh water conditions and mineral build-up



Ceramic Balancing Spool

- Allows for faster reaction time, reducing the risk of scalding
- Unaffected by harsh water conditions and mineral build-up

How to Order

Choose desired trim kit.



Trim kit with cartridge

+

Choose rough valve with desired connection.













Flash shower rough-in valve

=

Fully installed Bath/Shower















Trim Options

 <p>Colony® PRO</p>	 <p>Crawford™</p>	 <p>Delancey®</p>	 <p>Edgemere®</p>	 <p>Fluent®</p>	 <p>Glenmere™</p>
 <p>Reliant 3®</p>	 <p>Serin®</p>	 <p>Studio® S</p>	 <p>Town Square® S</p>	 <p>Townsend®</p>	

Freestanding Bathtub Faucets

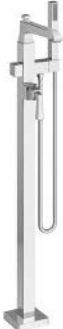
Bathroom Faucets

Freestanding Bathtub Faucets

Description	SKU #	Color/Finish	List Price
 <p>Contemporary Round Freestanding Bathtub Filler With Lever Handle Faucet for Flash® Rough-In Valve</p> <ul style="list-style-type: none"> • Brass construction and ¼-turn washerless ceramic disc valve cartridge • Personal shower features 59" (1499 mm) long hose with 1.8 gpm/6.8 L/min maximum flow • Metal lever handle • Overall height: 44-¾" (1137 mm) • Spout reach: 11-¼" (286 mm) • Metal hand shower • Shower bracket pivots 60° • For use with Flash® freestanding tub faucet rough-in valve (sold separately) 	 T064951.002	Polished Chrome	1,187
	T064951.243	Matte Black	1,780
	T064951.295	Brushed Nickel	1,662
	 		
 <p>Contemporary Square Freestanding Bathtub Faucet With Lever Handle for Flash® Rough-In Valve</p> <ul style="list-style-type: none"> • Brass construction and ¼-turn washerless ceramic disc valve cartridge • Personal shower features 59" (1499 mm) long hose with 1.8 gpm/6.8 L/min maximum flow • Metal lever handle • Overall height: 44-5/8" (1133 mm) • Spout reach: 10-3/8" (264 mm) • Level adjustable rough • Metal hand shower • Shower bracket pivots 60° • For use with Flash® freestanding tub faucet rough-in valve (sold separately) 	 T184951.002	Polished Chrome	1,244
	T184951.295	Brushed Nickel	1,742
	 		
 <p>Town Square® S Freestanding Bathtub Faucet With Lever Handle for Flash® Rough-In Valve</p> <ul style="list-style-type: none"> • Brass construction and ¼-turn washerless ceramic disc valve cartridge • Personal shower features 59" (1499 mm) long hose with 1.8 gpm/6.8 L/min maximum flow • Metal lever handle • Overall height: 43-½" (1105 mm) • Spout reach: 8-½" (218 mm) • Metal hand shower • Shower bracket pivots 60° • For use with Flash® freestanding tub faucet rough-in valve (sold separately) 	 T455951.002	Polished Chrome	1,384
	T455951.013	Polished Nickel	1,938
	T455951.278	Legacy Bronze	2,074
	T455951.295	Brushed Nickel	1,938
	  		

Freestanding Bathtub Faucets

Bathroom Faucets

	Description	SKU #	Color/Finish	List Price
	Cadet® Freestanding Bathtub Faucet With Lever Handle for Flash® Rough-In	 2764951.002	Polished Chrome	918
		2764951.278	Legacy Bronze	1,377
	<ul style="list-style-type: none"> • Brass construction and ¼-turn washerless ceramic disc valve cartridge • Personal shower features 59" (1499 mm) long hose with 1.8 gpm/6.8 L/min maximum flow • Metal lever handle • Overall height: 43" (1094 mm) • Spout reach: 8-1/8" (206 mm) • Metal hand shower • Includes rough-in 	2764951.295	Brushed Nickel	1,218
	Flash® Freestanding Bathtub Filler Rough-In Valve	R950	No Finish	230
	<ul style="list-style-type: none"> • Brass construction • ½" (13 mm) copper inlets • Level adjustable • Test plugs included • Must order trim separately 			
	Flash® Freestanding Bathtub Filler Rough-In Valve With Screwdriver Stops	R950SS	No Finish	265
<ul style="list-style-type: none"> • Brass construction • ½" (13 mm) copper inlets • Level adjustable • Test plugs included • Must order trim separately • Includes screwdriver stops for easy servicing at the valve 				

Freestanding Bathtub Faucets

The **Colony PRO Collection** is designed to complement any bathroom. Gently curved spout and lever handles add to its universal appeal and dependability.



Sink



Widespread Faucet
7075800



Monoblock Faucet
7075100



Centerset Faucet
7075000



Centerset Faucet
7075200

Bath



Bathtub Faucets
T075920, T075921

Shower



Bath/Shower Trim Kit
TU075508



2-Handle Shower Trim Kit
TU075508

Accessories



C Series 18" Towel Bar
8337018



C Series 24" Towel Bar
8337024













C Series Towel Ring
8337190







C Series
Toilet Paper Holder
8337230

















C Series
Double Robe Hook
8337210

	Description	ADA CEC	SKU #	Color/Finish	List Price
	Colony[®] PRO 8-Inch Widespread 2-Handle Bathroom Faucet 1.2 gpm/4.5 L/min With Lever Handles <ul style="list-style-type: none"> • ¼-turn washerless ceramic disc valve cartridges • Valve bodies with flexible hose connections for 6"-12" (152-305 mm) installations • Water-conserving 1.2 gpm/4.5 L/min pressure-compensating aerator • Metal spout • Braided flexible supply hose with 3/8" (10 mm) compression connectors • Red/Blue index button • Metal lever handles • Brass pop-up drain 		7075800.002	Polished Chrome	328
			7075800.278	Legacy Bronze	443
			7075800.295	Brushed Nickel	413
	Colony[®] PRO 8-Inch Widespread 2-Handle Bathroom Faucet 1.2 gpm/4.5 L/min With Lever Handles <ul style="list-style-type: none"> • ¼-turn washerless ceramic disc valve cartridges • Valve bodies with flexible hose connections for 6"-12" (152-305 mm) installations • Water-conserving 1.2 gpm/4.5 L/min pressure-compensating aerator • Metal spout • Braided flexible supply hose with 3/8" (10 mm) compression connectors • Red/Blue index button • Metal lever handles • 50/50 pop-up drain 		7075802.002	Polished Chrome	317
			7075802.278	Legacy Bronze	477
			7075802.295	Brushed Nickel	445
	Colony[®] PRO Single Hole Single-Handle Bathroom Faucet 1.2 gpm/4.5 L/min With Lever Handle <ul style="list-style-type: none"> • 35 mm ceramic disc valve cartridge with an adjustable Hot Limit Safety Stop • Braided flexible supply hoses with 3/8" (10 mm) compression connectors • All metal construction • Water-conserving 1.2 gpm/4.5 L/min pressure-compensating aerator • Red/Blue index button • Metal lever handle • Brass pop-up drain 		7075100.002	Polished Chrome	211
			7075100.278	Legacy Bronze	315
			7075100.295	Brushed Nickel	295
	Colony[®] PRO Single Hole Single-Handle Bathroom Faucet 1.2 gpm/4.5 Lpm With Lever Handle <ul style="list-style-type: none"> • 35 mm ceramic disc valve cartridge with an adjustable Hot Limit Safety Stop • Braided flexible supply hoses with 3/8" (10 mm) compression connectors • All metal construction • Water-conserving 1.2 gpm/4.5 L/min pressure-compensating aerator • Red/Blue index button • Metal lever handle • 50/50 pop-up drain 		7075102.002	Polished Chrome	199
			7075102.278	Legacy Bronze	301
			7075102.295	Brushed Nickel	279
	Colony[®] PRO Single Hole Single-Handle Bathroom Faucet 1.2 gpm/4.5 Lpm Less Drain With Lever Handle <ul style="list-style-type: none"> • 35 mm ceramic disc valve cartridge with an adjustable Hot Limit Safety Stop • Braided flexible supply hoses with 3/8" (10 mm) compression connectors • All metal construction • Water-conserving 1.2 gpm/4.5 L/min pressure-compensating aerator • Metal lever handle • Less pop-up hole and rod • Less drain 		7075104.002	Polished Chrome	190
			7075104.278	Legacy Bronze	285
			7075104.295	Brushed Nickel	266

	Description	SKU #	Color/Finish	List Price
	Universal Deck Plate <ul style="list-style-type: none"> • Metal construction • Putty plate included 	2000102P.002	Polished Chrome	50
		2000102P.013	Polished Nickel	70
		2000102P.278	Legacy Bronze	76
		2000102P.295	Brushed Nickel	70
	Colony® PRO 4-Inch Centerset Single-Handle Bathroom Faucet 1.2 gpm/4.5 L/min With Lever Handle <ul style="list-style-type: none"> • 35 mm ceramic disc valve cartridge with an adjustable Hot Limit Safety Stop • Braided flexible supply hoses with 3/8" (10 mm) compression connectors • Metal body with color-matched underbody • Water-conserving 1.2 gpm/4.5 L/min pressure-compensating aerator • Red/Blue index button • Metal lever handle • Brass pop-up drain 	7075000.002	Polished Chrome	173
		7075000.278	Legacy Bronze	261
		7075000.295	Brushed Nickel	242
	Colony® PRO 4-Inch Centerset Single-Handle Bathroom Faucet 1.2 gpm/4.5 Lpm With Lever Handle <ul style="list-style-type: none"> • 35 mm ceramic disc valve cartridge with an adjustable Hot Limit Safety Stop • Braided flexible supply hoses with 3/8" (10 mm) compression connectors • Metal body with color-matched underbody • Water-conserving 1.2 gpm/4.5 L/min pressure-compensating aerator • Metal lever handle • 50/50 pop-up drain 	7075002.002	Polished Chrome	163
		7075002.278	Legacy Bronze	245
		7075002.295	Brushed Nickel	228
	Colony® PRO 4-Inch Centerset Single-Handle Bathroom Faucet 1.2 gpm/4.5 L/min With Grid Drain and Lever Handle <ul style="list-style-type: none"> • 35 mm ceramic disc valve cartridge with an adjustable Hot Limit Safety Stop • Braided flexible supply hoses with 3/8" (10 mm) compression connectors • Metal body with color-matched underbody • Water-conserving 1.2 gpm/4.5 L/min pressure-compensating aerator • Red/Blue index button • Metal lever handle • Less pop-up hole and rod • Grid drain 	7075006.002	Polished Chrome	165
	Colony® PRO 4-Inch Centerset Single-Handle Bathroom Faucet 1.2 gpm/4.5 Lpm Less Drain With Lever Handle <ul style="list-style-type: none"> • 35 mm ceramic disc valve cartridge with an adjustable Hot Limit Safety Stop • Braided flexible supply hoses with 3/8" (10 mm) compression connectors • Metal body with color-matched underbody • Water-conserving 1.2 gpm/4.5 L/min pressure-compensating aerator • Red/Blue index button • Metal lever handle • With pop-up hole and rod • Less drain 	7075005.002	Polished Chrome	153
		7075005.278	Legacy Bronze	230
		7075005.295	Brushed Nickel	214

	Description	SKU #	Color/Finish	List Price
	<p>Colony® PRO 4-Inch Centerset Single-Handle Bathroom Faucet 1.2 gpm/4.5 Lpm Less Drain With Lever Handle</p> <ul style="list-style-type: none"> • 35 mm ceramic disc valve cartridge with an adjustable Hot Limit Safety Stop • Braided flexible supply hoses with 3/8" (10 mm) compression connectors • Metal body with color-matched underbody • Water-conserving 1.2 gpm/4.5 L/min pressure-compensating aerator • Red/Blue index button • Metal lever handle • Less pop-up hole and rod • Less drain 	<p>7075004.002 7075004.295</p>	<p>Polished Chrome Brushed Nickel</p>	<p>153 214</p>
	<p>Colony® PRO 4-Inch Centerset Single-Handle Bathroom Faucet 0.5 gpm/1.9 L/min With Lever Handle</p> <ul style="list-style-type: none"> • 35 mm ceramic disc valve cartridge with an adjustable Hot Limit Safety Stop • Braided flexible supply hoses with 3/8" (10 mm) compression connectors • Metal body with color-matched underbody • Water-conserving 0.5 gpm/1.9 L/min vandal-resistant pressure-compensating spray • Red/Blue index button • Metal lever handle • Brass pop-up drain 	<p>7075050.002</p>	<p>Polished Chrome</p>	<p>179</p>
	<p>Colony® PRO 4-Inch Centerset Single-Handle Bathroom Faucet 0.5 gpm/1.9 L/min With Lever Handle</p> <ul style="list-style-type: none"> • 35 mm ceramic disc valve cartridge with an adjustable Hot Limit Safety Stop • Braided flexible supply hoses with 3/8" (10 mm) compression connectors • Metal body with color-matched underbody • Water-conserving 0.5 gpm/1.9 L/min vandal-resistant pressure-compensating spray • Red/Blue index button • Metal lever handle • Grid drain 	<p>7075056.002</p>	<p>Polished Chrome</p>	<p>172</p>
	<p>Colony® PRO 4-Inch Centerset Single-Handle Bathroom Faucet 0.5 gpm/1.9 L/min Less Drain With Lever Handle</p> <ul style="list-style-type: none"> • 35 mm ceramic disc valve cartridge with an adjustable Hot Limit Safety Stop • Braided flexible supply hoses with 3/8" (10 mm) compression connectors • Metal body with color-matched underbody • Water-conserving 0.5 gpm/1.9 L/min vandal-resistant pressure-compensating spray • Red/Blue index button • Metal lever handle • With pop-up hole and rod • Less drain 	<p>7075055.002</p>	<p>Polished Chrome</p>	<p>159</p>

	Description	ADA CEC	SKU #	Color/Finish	List Price
	<p>Colony® PRO 4-Inch Centerset Single-Handle Bathroom Faucet 0.5 gpm/1.9 L/min Less Drain With Lever Handle</p> <ul style="list-style-type: none"> • 35 mm ceramic disc valve cartridge with an adjustable Hot Limit Safety Stop • Braided flexible supply hoses with 3/8" (10 mm) compression connectors • Metal body with color-matched underbody • Water-conserving 0.5 gpm/1.9 L/min vandal-resistant pressure-compensating spray • Red/Blue index button • Metal lever handle • Less pop-up hole and rod • Less drain 		<p>7075054.002</p>	<p>Polished Chrome</p>	<p>159</p>
	<p>Colony® PRO 4-Inch Centerset 2-Handle Bathroom Faucet 1.2 gpm/4.5 L/min With Lever Handles</p> <ul style="list-style-type: none"> • 40 mm ceramic disc valve cartridges • ½" (13 mm) male inlet shanks • Metal body with color-matched underbody • Water-conserving 1.2 gpm/4.5 L/min pressure-compensating aerator • Red/Blue index buttons • Metal lever handles • Brass pop-up drain 		<p>7075200.002 7075200.278 7075200.295</p>	<p>Polished Chrome Legacy Bronze Brushed Nickel</p>	<p>144 216 200</p>
	<p>Colony® PRO 4-Inch Centerset 2-Handle Bathroom Faucet 1.0 gpm/3.8 Lpm With Lever Handles</p> <ul style="list-style-type: none"> • 40 mm ceramic disc valve cartridges • ½" (13 mm) male inlet shanks • Metal body with color-matched underbody • Water-conserving 1.0 gpm/3.8 L/min pressure-compensating aerator • Red/Blue index buttons • Metal lever handles • With metal drain 		<p>7075200F10.002</p>	<p>Polished Chrome</p>	<p>140</p>
	<p>Colony® PRO 4-Inch Centerset 2-Handle Bathroom Faucet 0.5 gpm/1.9 Lpm With Lever Handles</p> <ul style="list-style-type: none"> • 40 mm ceramic disc valve cartridges • ½" (13 mm) male inlet shanks • Metal body with color-matched underbody • Water-conserving 0.5 gpm/1.9 L/min pressure-compensating aerator • Red/Blue index buttons • Metal lever handles • With metal drain 		<p>7075F05200.002</p>	<p>Polished Chrome</p>	<p>135</p>
	<p>Colony® PRO 4-Inch Centerset 2-Handle Bathroom Faucet 1.2 gpm/4.5 Lpm With Lever Handles</p> <ul style="list-style-type: none"> • 40 mm ceramic disc valve cartridges • ½" (13 mm) male inlet shanks • Metal body with color-matched underbody • Water-conserving 1.2 gpm/4.5 L/min pressure-compensating aerator • Red/Blue index buttons • Metal lever handles • 50/50 pop-up drain 		<p>7075202.002 7075202.278 7075202.295</p>	<p>Polished Chrome Legacy Bronze Brushed Nickel</p>	<p>135 200 188</p>

	Description	SKU #	Color/Finish	List Price
	Colony® PRO 4-Inch Centerset 2-Handle Bathroom Faucet 1.2 gpm/4.5 Lpm Less Drain, With Lever Handles <ul style="list-style-type: none"> • 40 mm ceramic disc valve cartridges • ½" (13 mm) male inlet shanks • Metal body with color-matched underbody • Water-conserving 1.2 gpm/4.5 L/min pressure-compensating aerator • Red/Blue index buttons • Metal lever handles • With pop-up hole and rod • Less drain 	 7075205.002	Polished Chrome	125
		7075205.278	Legacy Bronze	187
		7075205.295	Brushed Nickel	175
		<hr/>		
	Colony® PRO Bathtub Faucet Trim With Lever Handles and Personal Shower for Flash® Rough-In Valve <ul style="list-style-type: none"> • Brass construction • Personal shower features 60" (152 cm) long hose, 1.8 gpm/6.8 L/min maximum flow • Metal lever handles • For use with Flash® bathtub faucet rough-in valve R910 • Installs with Flash® rough valve platform • Includes personal shower 	 T075921.002	Polished Chrome	485
		T075921.278	Legacy Bronze	582
		T075921.295	Brushed Nickel	582
		<hr/>		
	Colony® PRO Bathtub Faucet Trim With Lever Handles for Flash® Rough-In Valve <ul style="list-style-type: none"> • Brass construction • Metal lever handles • Less personal shower • For use with Flash® bathtub faucet rough-in valve R900 • Installs with Flash® rough valve platform 	 T075920.002	Polished Chrome	405
		T075920.278	Legacy Bronze	605
		T075920.295	Brushed Nickel	565
		<hr/>		
	Flash® Bathtub Filler Rough-In Valve With Personal Shower <ul style="list-style-type: none"> • Brass construction and washerless ¼-turn ceramic disc valves cartridge • ½" (13 mm) copper inlets • Connections to spout can be made via flexible hoses (provided) or ½" (13 mm) copper sweat connections • 14 gpm/59.2 L/min maximum flow rate at 40 psi • 8"-16" (203-406 mm) flexible installation • Adjustable rough-in: 2-½" (64 mm) maximum deck thickness • Includes hand shower rough-in 	R910	No Finish	322
				
	Flash® Bathtub Filler Rough-In Valve <ul style="list-style-type: none"> • Brass construction and washerless ¼-turn ceramic disc valve cartridges • ½" (13 mm) copper inlets • Connections to spout can be made via flexible hoses (provided) or ½" (13 mm) copper sweat connections • 14 gpm/52.9 L/min maximum flow rate at 40 psi • 8"-16" (203-406 mm) flexible installation • Adjustable rough-in: 2-½" (64 mm) maximum deck thickness 	R900	No Finish	184
				

HOW TO ORDER

Choose desired trim kit.



Trim kit with cartridge

Choose rough-in valve with desired connection.











Flash[®] Shower Rough-In Valve





Fully installed Bath/Shower



Colony PRO

	Description	SKU #	Color/Finish	List Price
 	<p>Colony[®] PRO 1.75 gpm/6.6 L/min Shower Trim Kit With Water-Saving Showerhead, Double Ceramic Pressure Balance Cartridge With Lever Handle</p> <ul style="list-style-type: none"> • Includes Double Ceramic pressure balance cartridge • Water-saving 3-³/₄" (96 mm) showerhead, 1.75 gpm/6.6 L/min maximum flow • Shower arm and flange • Wall escutcheon with Red/Blue indicators • Metal lever handle • For use with Flash[®] shower rough-in valves 	 	<p>TU075507.002 Polished Chrome 108 TU075507.278 Legacy Bronze 148 TU075507.295 Brushed Nickel 140</p>	
 	<p>Colony[®] PRO 1.75 gpm/6.6 L/min Tub and Shower Trim Kit With Water-Saving Showerhead, Double Ceramic Pressure Balance Cartridge With Lever Handle</p> <ul style="list-style-type: none"> • Includes Double Ceramic pressure balance cartridge • Water-Saving 3-³/₄" (96 mm) showerhead, 1.75 gpm/6.6 L/min maximum flow • Shower arm and flange • Wall escutcheon with Red/Blue indicators • Metal lever handle • Slip-On diverter tub spout • For use with Flash[®] shower rough-in valves 		<p>TU075508.002 Polished Chrome 137 TU075508.278 Legacy Bronze 190 TU075508.295 Brushed Nickel 178</p>	
	<p>Colony PRO[®] Valve Only Trim Kit With Double Ceramic Pressure Balance Cartridge With Lever Handle</p> <ul style="list-style-type: none"> • Includes Double Ceramic pressure balance cartridge • Wall escutcheon with Red/Blue indicators • Metal lever handle • For use with Flash[®] shower rough-in valves • Integrated check valves: engineered to eliminate cross flow • Adjustable Hot Limit Safety Stop: limits the amount of hot water allowed to mix with cold. Reduces the risk of accidental scalding • Comfort zone: offers a wider shower range to fine-tune the desired temperature within the useful temperature zone • Back-to-back capability: hot and cold can be reversed quickly and easily 		<p>TU075500.002 Polished Chrome 83 TU075500.278 Legacy Bronze 108 TU075500.295 Brushed Nickel 104</p>	

	Description	SKU #	Color/Finish	List Price
   	<p>Colony® PRO Tub and Shower Trim Kit Less Showerhead, Double Ceramic Pressure Balance Cartridge With Lever Handle</p> <ul style="list-style-type: none"> • Includes Double Ceramic pressure balance cartridge • Shower arm and flange, less showerhead • Wall escutcheon with Red/Blue indicators • Metal lever handle • Slip-on diverter tub spout • For use with Flash® shower rough-in valves 	 <p>TU075508XH.002</p>	<p>Polished Chrome</p>	<p>135</p>
 	<p>Colony® PRO Shower Trim Kit Less Showerhead, Double Ceramic Pressure Balance Cartridge With Lever Handle</p> <ul style="list-style-type: none"> • Includes Double Ceramic pressure balance cartridge • Shower arm and flange, less showerhead • Wall escutcheon with Red/Blue indicators • Metal lever handle • For use with Flash® shower rough-in valves 	 <p>TU075507XH.002 TU075507XH.278</p>	<p>Polished Chrome Legacy Bronze</p>	<p>106 144</p>

	Description	SKU #	Color/Finish	List Price
	<p>Flash® Shower Rough-In Valve With Universal Inlets/Outlets</p> <ul style="list-style-type: none"> • ½" (13 mm) male NPT/Sweat inlets/outlets accept ½" copper, ½" iron pipe, PEX or CPVC adapters • Cast DZR brass valve body • Flow rate: 5.1 gpm @ 45 psi* • Back-to-back capability • Includes flush plug with stainless steel ring • Cartridge ships with trim • For use with TU series pressure balance bath/shower trim kits 	RU101	No Finish	72
	<p>Flash® Shower Rough-In Valve With Universal Inlets/Outlets With Screwdriver Stops</p> <ul style="list-style-type: none"> • ½" (13 mm) male NPT/Sweat inlets/outlets accept ½" copper, ½" iron pipe, PEX or CPVC adapters • Cast DZR brass valve body • Flow rate: 5.1 gpm @ 45 psi* • Back-to-back capability • Includes flush plug with stainless steel ring • Includes screwdriver stops for easy servicing at the valve • For use with TU series pressure balance bath/shower trim kits 	RU101SS	No Finish	103
	<p>Flash® Shower Rough-In Valve With Stub-Outs</p> <ul style="list-style-type: none"> • ½" (13 mm) Stub-out inlets/outlets accept ½" press-connect fittings • Cast DZR brass valve body • Flow rate: 5.1 gpm @ 45 psi* • Back-to-back capability • Includes flush plug with stainless steel ring • Cartridge ships with trim • For use with TU series pressure balance bath/shower trim kits 	RU102	No Finish	72
	<p>Flash® Shower Rough-In Valve With Stub-Outs With Screwdriver Stops</p> <ul style="list-style-type: none"> • ½" (13 mm) Stub-out inlets/outlets accept ½" press-connect fittings • Cast DZR brass valve body • Flow rate: 5.1 gpm @ 45 psi* • Back-to-back capability • Includes flush plug with stainless steel ring • Includes screwdriver stops for easy servicing at the valve • Cartridge ships with trim • For use with TU series pressure balance bath/shower trim kits 	RU102SS	No Finish	103
	<p>Flash® Shower Rough-In Valve With PEX Inlets/Universal Outlets for Crimp Ring System</p> <ul style="list-style-type: none"> • ½" (3 mm) PEX crimp inlets/Universal outlets (ASTM F1807) • Cast DZR brass valve body • Flow rate: 5.1 gpm @ 45 psi* • Back-to-back capability • Includes flush plug with stainless steel ring • Cartridge ships with trim • For use with TU series pressure balance bath/shower trim kits 	RU107	No Finish	72















*When combined with Double Ceramic pressure balance cartridge.

	Description	SKU #	Color/Finish	List Price
	<p>Flash[®] Shower Rough-In Valve With PEX Inlets/Universal Outlets With Screwdriver Stops for Crimp Ring System</p> <ul style="list-style-type: none"> • ½" (13 mm) PEX crimp inlets/Universal outlets (ASTM F1807) • Cast DZR brass valve body • Flow rate: 5.1 gpm @ 45 psi* • Back-to-back capability • Includes flush plug with stainless steel ring • Includes screwdriver stops for easy servicing at the valve • Cartridge ships with trim • For use with TU series pressure balance bath/shower trim kits 	RU107SS	No Finish	103 
	<p>Flash[®] Shower Rough-In Valve With PEX Inlet Elbows/Universal Outlets for Crimp Ring System</p> <ul style="list-style-type: none"> • ½" (13 mm) PEX crimp elbow inlets/Universal outlets (ASTM F1807) • Cast DZR brass valve body • Flow rate: 5.1 gpm @ 45 psi* • Back-to-back capability • Includes flush plug with stainless steel ring • Cartridge ships with trim • For use with TU series pressure balance bath/shower trim kits 	RU107E	No Finish	95 
	<p>Flash[®] Shower Rough-In Valve With PEX Inlet Elbows/Universal Outlets With Screwdriver Stops for Crimp Ring System</p> <ul style="list-style-type: none"> • ½" (13 mm) PEX crimp elbow inlets/Universal outlets (ASTM F1807) • Cast DZR brass valve body • Flow rate: 5.1 gpm @ 45 psi* • Back-to-back capability • Includes flush plug with stainless steel ring • Includes screwdriver stops for easy servicing at the valve • Cartridge ships with trim • For use with TU series pressure balance bath/shower trim kits 	RU107ESS	No Finish	125 
	<p>Flash[®] Shower Rough-In Valve With PEX Inlets/Universal Outlets for Cold Expansion System</p> <ul style="list-style-type: none"> • ½" (13 mm) PEX cold expansion inlets/Universal outlets (ASTM F1960) • Cast DZR brass valve body • Flow rate: 5.1 gpm @ 45 psi* • Back-to-back capability • Includes flush plug with stainless steel ring • Cartridge ships with trim • For use with TU series pressure balance bath/shower trim kits 	RU108	No Finish	72 
	<p>Flash[®] Shower Rough-In Valve With PEX Inlets/Universal Outlets With Screwdriver Stops for Cold Expansion System</p> <ul style="list-style-type: none"> • ½" (13 mm) PEX cold expansion inlets/Universal outlets (ASTM F1960) • Cast DZR brass valve body • Flow rate: 5.1 gpm @ 45 psi* • Back-to-back capability • Includes flush plug with stainless steel ring • Includes screwdriver stops for easy servicing at the valve • For use with TU series pressure balance bath/shower trim kits 	RU108SS	No Finish	103 

*When combined with Double Ceramic pressure balance cartridge.

	Description	SKU #	Color/Finish	List Price
	<p>Flash® Shower Rough-In Valve With PEX Inlet Elbows/Universal Outlets for Cold Expansion System</p> <ul style="list-style-type: none"> • ½" (13 mm) PEX cold expansion elbow inlets/ Universal outlets (ASTM F1960) • Cast DZR brass valve body • Flow rate: 5.1 gpm @ 45 psi* • Back-to-back capability • Includes flush plug with stainless steel ring • Cartridge ships with trim • For use with TU series pressure balance bath/ shower trim kits 	RU108E	No Finish	95 
	<p>Flash® Shower Rough-In Valve With PRX Inlet Elbows/Universal Outlets With Screwdriver Stops for Cold Expansion System</p> <ul style="list-style-type: none"> • ½" (13 mm) PEX cold expansion elbow inlets/ Universal outlets (ASTM F1960) • Cast DZR brass valve body • Flow rate: 5.1 gpm @ 45 psi* • Back-to-back capability • Includes flush plug with stainless steel ring • Includes screwdriver stops for easy servicing at the valve • Cartridge ships with trim • For use with TU series pressure balance bath/ shower trim kits 	RU108ESS	No Finish	125 
	<p>Flash® Shower Rough-In Valve With CPVC Inlets/Universal Outlets</p> <ul style="list-style-type: none"> • ½" (13 mm) CPVC inlets/Universal outlets • Cast DZR brass valve body • Flow rate: 5.1 gpm @ 45 psi* • Back-to-back capability • Includes flush plug with stainless steel ring • Cartridge ships with trim • For use with TU series pressure balance bath/ shower trim kits 	RU109	No Finish	95 
	<p>Flash® Shower Rough-In Valve With CPVC Inlets/Universal Outlets With Screwdriver Stops</p> <ul style="list-style-type: none"> • ½" (13 mm) CPVC inlets/Universal outlets • Cast DZR brass valve body • Flow rate: 5.1 gpm @ 45 psi* • Back-to-back capability • Includes flush plug with stainless steel ring • Includes screwdriver stops for easy servicing at the valve • Cartridge ships with trim • For use with TU series pressure balance bath/ shower trim kits 	RU109SS	No Finish	125 

*When combined with Double Ceramic pressure balance cartridge.

	Description	SKU #	Color/Finish	List Price
	C Series 18-Inch Towel Bar	8337018.002	Polished Chrome	66
	• Brass bar	8337018.013	Polished Nickel	92
	• All metal construction	8337018.278	Legacy Bronze	100
	• Concealed mounting: no exposed set screws	8337018.295	Brushed Nickel	92
	• Easy to install			
	• Limited lifetime warranty on function and finish			
			 	
	C Series 24-Inch Towel Bar	8337024.002	Polished Chrome	70
	• Brass bar	8337024.013	Polished Nickel	98
	• All metal construction	8337024.278	Legacy Bronze	104
	• Concealed mounting: no exposed set screws	8337024.295	Brushed Nickel	98
	• Easy to install			
	• Limited lifetime warranty on function and finish			
			 	
	C Series Towel Ring	8337190.002	Polished Chrome	41
	• Concealed mounting with no exposed screws for a seamless appearance	8337190.013	Polished Nickel	57
	• Bushing on towel ring to prevent scratching and squeaking	8337190.278	Legacy Bronze	61
	• Easy to install	8337190.295	Brushed Nickel	57
	• 7" (178 mm) diameter ring			
	• Limited lifetime warranty on function and finish			
			 	
	C Series Double Robe Hook	8337210.002	Polished Chrome	31
	• All metal construction	8337210.013	Polished Nickel	43
	• Concealed mounting: no exposed set screws	8337210.278	Legacy Bronze	43
	• Easy to install	8337210.295	Brushed Nickel	43
	• Limited lifetime warranty on function and finish			
	• Solid metal construction is durable and long-lasting			
			 	
	C Series Toilet Paper Holder	8337230.002	Polished Chrome	53
	• All metal construction	8337230.013	Polished Nickel	76
	• Concealed mounting: no exposed set screws	8337230.278	Legacy Bronze	82
	• Easy to install	8337230.295	Brushed Nickel	76
	• Limited lifetime warranty on function and finish			
			 	



The transitional style of the **Crawford Collection** brings casual elegance to the bathroom. This impressive design, with a tapered shape and subtle detailing, offers exceptional functionality.

Crawford



Sink



Widespread Faucet
7612807



Centerset Faucet
7612207



Monoblock Faucet
7612107

Bath



Bathtub Faucet Trim Kit
T612900

Shower



Bath/Shower Trim Kits
TU612508



Shower Only Trim Kits
TU612507

Accessories



24" Towel Bar
7455024







Towel Ring
7455190







Toilet Paper Holder
7455230



Double Robe Hook
7455210

	Description	SKU #	Color/Finish	List Price
	Crawford™ 8-Inch Widespread 2-Handle Bathroom Faucet 1.2 gpm/4.5 L/min With Lever Handles <ul style="list-style-type: none"> • Metal construction • Washerless ceramic disc valve cartridges • Water-conserving 1.2 gpm/4.5 L/min pressure-compensating aerator • Metal spout • Brass hybrid valves with reinforced flexible hose connections for 6" - 12" (152 - 305 mm) installations • Braided flexible supply hoses with 3/8" (10 mm) compression connectors • Metal lever handles • Metal push pop up drain 	 7612807.002	Polished Chrome	366
		 7612807.243	Matte Black	477
		7612807.278	Legacy Bronze	440
		7612807.295	Brushed Nickel	440
	Crawford™ 4-Inch Centerset 2-Handle Bathroom Faucet 1.2 gpm/4.5 L/min With Lever Handles <ul style="list-style-type: none"> • Metal construction • Washerless ceramic disc valve cartridges • Water-conserving 1.2 gpm/4.5 L/min pressure-compensating aerator • Metal spout • Metal lever handles • Metal push pop up drain 	 7612207.002	Polished Chrome	163
		 7612207.243	Matte Black	212
		7612207.278	Legacy Bronze	195
		7612207.295	Brushed Nickel	195
	Crawford™ Single Hole Single-Handle Bathroom Faucet 1.2 gpm/4.5 L/min With Lever Handle <ul style="list-style-type: none"> • Metal construction • Washerless ceramic disc valve cartridges • Water-conserving 1.2 gpm/4.5 L/min pressure-compensating aerator • Metal spout • Braided flexible supply hoses with 3/8" (10 mm) compression connectors • Metal lever handle • Metal push pop up drain 	 7612107.002	Polished Chrome	255
		 7612107.243	Matte Black	332
		7612107.278	Legacy Bronze	307
		7612107.295	Brushed Nickel	307
	4-Inch Deck Plate <ul style="list-style-type: none"> • Metal construction • Putty plate included 	7353101P.002	Polished Chrome	46
		7353101P.013	Polished Nickel	63
		7353101P.243	Matte Black	66
		7353101P.278	Legacy Bronze	67
		7353101P.295	Brushed Nickel	63



	Description	SKU #	Color/Finish	List Price
	Crawford™ Bathtub Faucet With Lever Handles for Flash® Rough-In Valve	 T612900.002	Polished Chrome	558
		T612900.243	Matte Black	725
	<ul style="list-style-type: none"> • Brass construction • Metal lever handles • Less personal shower 	T612900.278	Legacy Bronze	670
		T612900.295	Brushed Nickel	670
	Flash® Bathtub Filler Rough-In Valve	R900	No Finish	184
<ul style="list-style-type: none"> • Brass construction and washerless ¼-turn ceramic disc valve cartridges • ½" (13 mm) copper inlets • Connections to spout can be made via flexible hoses (provided) or ½" (13 mm) copper sweat connections • 14 gpm/52.9 L/min maximum flow rate at 40 psi • 8"-16" (203-406 mm) flexible installation • Adjustable rough-in: 2-½" (64 mm) maximum deck thickness 				

HOW TO ORDER

Choose desired trim kit.



Trim kit with cartridge



Choose rough-in valve with desired connection.



Flash® Shower Rough-In Valve



Fully installed Bath/Shower



Description

SKU #

Color/Finish

List Price

Crawford™ 1.8 gpm/6.8 L/min Tub and Shower Trim Kit With Water-Saving Showerhead, Double Ceramic Pressure Balance Cartridge With Lever Handle



- TU612508.002
- TU612508.243
- TU612508.278
- TU612508.295

- Polished Chrome
- Matte Black
- Legacy Bronze
- Brushed Nickel

- 187
- 243
- 224
- 224

- Includes Double Ceramic pressure balance cartridge
- Water-saving showerhead, 1.8 gpm/6.8 L/min maximum flow
- Shower arm and flange
- Brass wall escutcheon
- Metal lever handle
- IPS diverter tub spout
- For use with Flash® shower rough-in valves



Crawford™ 1.8 gpm/6.8 L/min Shower Trim Kit With Water-Saving Showerhead, Double Ceramic Pressure Balance Cartridge With Lever Handle







- TU612507.002
- TU612507.243
- TU612507.278
- TU612507.295

- Polished Chrome
- Matte Black
- Legacy Bronze
- Brushed Nickel

- 224
- 292
- 269
- 269

- Includes Double Ceramic pressure balance cartridge
- Water-saving showerhead, 1.8 gpm/6.8 L/min maximum flow
- Shower arm and flange
- Brass wall escutcheon
- Metal lever handle
- For use with Flash® shower rough-in valves















	Description	SKU #	Color/Finish	List Price
	<p>Flash® Shower Rough-In Valve With Universal Inlets/Outlets</p> <ul style="list-style-type: none"> • ½" (13 mm) male NPT/Sweat inlets/outlets accept ½" copper, ½" iron pipe, PEX or CPVC adapters • Cast DZR brass valve body • Flow rate: 5.1 gpm @ 45 psi* • Back-to-back capability • Includes flush plug with stainless steel ring • Cartridge ships with trim • For use with TU series pressure balance bath/shower trim kits 	RU101	No Finish	72
	<p>Flash® Shower Rough-In Valve With Universal Inlets/Outlets With Screwdriver Stops</p> <ul style="list-style-type: none"> • ½" (13 mm) male NPT/Sweat inlets/outlets accept ½" copper, ½" iron pipe, PEX or CPVC adapters • Cast DZR brass valve body • Flow rate: 5.1 gpm @ 45 psi* • Back-to-back capability • Includes flush plug with stainless steel ring • Includes screwdriver stops for easy servicing at the valve • For use with TU series pressure balance bath/shower trim kits 	RU101SS	No Finish	103
	<p>Flash® Shower Rough-In Valve With Stub-Outs</p> <ul style="list-style-type: none"> • ½" (13 mm) Stub-out inlets/outlets accept ½" press-connect fittings • Cast DZR brass valve body • Flow rate: 5.1 gpm @ 45 psi* • Back-to-back capability • Includes flush plug with stainless steel ring • Cartridge ships with trim • For use with TU series pressure balance bath/shower trim kits 	RU102	No Finish	72
	<p>Flash® Shower Rough-In Valve With Stub-Outs With Screwdriver Stops</p> <ul style="list-style-type: none"> • ½" (13 mm) Stub-out inlets/outlets accept ½" press-connect fittings • Cast DZR brass valve body • Flow rate: 5.1 gpm @ 45 psi* • Back-to-back capability • Includes flush plug with stainless steel ring • Includes screwdriver stops for easy servicing at the valve • Cartridge ships with trim • For use with TU series pressure balance bath/shower trim kits 	RU102SS	No Finish	103
	<p>Flash® Shower Rough-In Valve With PEX Inlets/Universal Outlets for Crimp Ring System</p> <ul style="list-style-type: none"> • ½" (3 mm) PEX crimp inlets/Universal outlets (ASTM F1807) • Cast DZR brass valve body • Flow rate: 5.1 gpm @ 45 psi* • Back-to-back capability • Includes flush plug with stainless steel ring • Cartridge ships with trim • For use with TU series pressure balance bath/shower trim kits 	RU107	No Finish	72

*When combined with Double Ceramic pressure balance cartridge.

	Description	SKU #	Color/Finish	List Price	
	<p>Flash® Shower Rough-In Valve With PEX Inlets/Universal Outlets With Screwdriver Stops for Crimp Ring System</p> <ul style="list-style-type: none"> • ½" (13 mm) PEX crimp inlets/Universal outlets (ASTM F1807) • Cast DZR brass valve body • Flow rate: 5.1 gpm @ 45 psi* • Back-to-back capability • Includes flush plug with stainless steel ring • Includes screwdriver stops for easy servicing at the valve • Cartridge ships with trim • For use with TU series pressure balance bath/shower trim kits 	RU107SS	No Finish	103	
		<p>Flash® Shower Rough-In Valve With PEX Inlet Elbows/Universal Outlets for Crimp Ring System</p> <ul style="list-style-type: none"> • ½" (13 mm) PEX crimp elbow inlets/Universal outlets (ASTM F1807) • Cast DZR brass valve body • Flow rate: 5.1 gpm @ 45 psi* • Back-to-back capability • Includes flush plug with stainless steel ring • Cartridge ships with trim • For use with TU series pressure balance bath/shower trim kits 	RU107E	No Finish	95
		<p>Flash® Shower Rough-In Valve With PEX Inlet Elbows/Universal Outlets With Screwdriver Stops for Crimp Ring System</p> <ul style="list-style-type: none"> • ½" (13 mm) PEX crimp elbow inlets/Universal outlets (ASTM F1807) • Cast DZR brass valve body • Flow rate: 5.1 gpm @ 45 psi* • Back-to-back capability • Includes flush plug with stainless steel ring • Includes screwdriver stops for easy servicing at the valve • Cartridge ships with trim • For use with TU series pressure balance bath/shower trim kits 	RU107ESS	No Finish	125
		<p>Flash® Shower Rough-In Valve With PEX Inlets/Universal Outlets for Cold Expansion System</p> <ul style="list-style-type: none"> • ½" (13 mm) PEX cold expansion inlets/Universal outlets (ASTM F1960) • Cast DZR brass valve body • Flow rate: 5.1 gpm @ 45 psi* • Back-to-back capability • Includes flush plug with stainless steel ring • Cartridge ships with trim • For use with TU series pressure balance bath/shower trim kits 	RU108	No Finish	72
		<p>Flash® Shower Rough-In Valve With PEX Inlets/Universal Outlets With Screwdriver Stops for Cold Expansion System</p> <ul style="list-style-type: none"> • ½" (13 mm) PEX cold expansion inlets/Universal outlets (ASTM F1960) • Cast DZR brass valve body • Flow rate: 5.1 gpm @ 45 psi* • Back-to-back capability • Includes flush plug with stainless steel ring • Includes screwdriver stops for easy servicing at the valve • For use with TU series pressure balance bath/shower trim kits 	RU108SS	No Finish	103
	<p>*When combined with Double Ceramic pressure balance cartridge.</p>				

	Description	SKU #	Color/Finish	List Price
	<p>Flash® Shower Rough-In Valve With PEX Inlet Elbows/Universal Outlets for Cold Expansion System</p> <ul style="list-style-type: none"> • ½" (13 mm) PEX cold expansion elbow inlets/ Universal outlets (ASTM F1960) • Cast DZR brass valve body • Flow rate: 5.1 gpm @ 45 psi* • Back-to-back capability • Includes flush plug with stainless steel ring • Cartridge ships with trim • For use with TU series pressure balance bath/ shower trim kits 	RU108E	No Finish	95 
	<p>Flash® Shower Rough-In Valve With PRX Inlet Elbows/Universal Outlets With Screwdriver Stops for Cold Expansion System</p> <ul style="list-style-type: none"> • ½" (13 mm) PEX cold expansion elbow inlets/ Universal outlets (ASTM F1960) • Cast DZR brass valve body • Flow rate: 5.1 gpm @ 45 psi* • Back-to-back capability • Includes flush plug with stainless steel ring • Includes screwdriver stops for easy servicing at the valve • Cartridge ships with trim • For use with TU series pressure balance bath/ shower trim kits 	RU108ESS	No Finish	125 
	<p>Flash® Shower Rough-In Valve With CPVC Inlets/Universal Outlets</p> <ul style="list-style-type: none"> • ½" (13 mm) CPVC inlets/Universal outlets • Cast DZR brass valve body • Flow rate: 5.1 gpm @ 45 psi* • Back-to-back capability • Includes flush plug with stainless steel ring • Cartridge ships with trim • For use with TU series pressure balance bath/ shower trim kits 	RU109	No Finish	95 
	<p>Flash® Shower Rough-In Valve With CPVC Inlets/Universal Outlets With Screwdriver Stops</p> <ul style="list-style-type: none"> • ½" (13 mm) CPVC inlets/Universal outlets • Cast DZR brass valve body • Flow rate: 5.1 gpm @ 45 psi* • Back-to-back capability • Includes flush plug with stainless steel ring • Includes screwdriver stops for easy servicing at the valve • Cartridge ships with trim • For use with TU series pressure balance bath/ shower trim kits 	RU109SS	No Finish	125 

*When combined with Double Ceramic pressure balance cartridge.

	Description	SKU #	Color/Finish	List Price
	Town Square® S 24-Inch Towel Bar	7455024.002	Polished Chrome	76
	• Brass bar	7455024.013	Polished Nickel	105
	• All metal construction	7455024.278	Legacy Bronze	112
	• Concealed mounting: no exposed set screws	7455024.295	Brushed Nickel	105
	• Coordinates with Town Square® S bath faucet collection			
	• Limited lifetime warranty on function and finish			 
	Town Square® S Towel Ring	7455190.002	Polished Chrome	45
	• Part of the coordinated Town Square S® collection	7455190.013	Polished Nickel	61
	• Concealed mounting with no exposed screws for a seamless appearance	7455190.278	Legacy Bronze	66
	• Bushing on towel ring to prevent scratching and squeaking	7455190.295	Brushed Nickel	61
	• Easy to install			
	• 7" (178 mm) diameter ring			 
	• Limited lifetime warranty on function and finish			
	Town Square® S Double Robe Hook	7455210.002	Polished Chrome	32
	• All metal construction	7455210.013	Polished Nickel	45
	• Concealed mounting: no exposed set screws	7455210.278	Legacy Bronze	45
	• Coordinates with Town Square S® bath faucet collection	7455210.295	Brushed Nickel	45
	• Easy to install			
	• Limited lifetime warranty on function and finish			 
	• Solid metal construction is durable and long-lasting			
	Town Square® S Toilet Paper Holder	7455230.002	Polished Chrome	57
	• All metal construction	7455230.013	Polished Nickel	80
	• Concealed mounting: no exposed set screws	7455230.278	Legacy Bronze	86
	• Coordinates with Town Square® S bath faucet collection	7455230.295	Brushed Nickel	80
	• Easy to install			
	• Limited lifetime warranty on function and finish			 



Crawford

Inspired by the finer points of classic architecture, the **Delancey Collection** from American Standard transforms today's bathroom with its timeless character and enduring elegance. Worthy of the master retreat, impressive in the guest bath, this graceful style is engineered to last a lifetime.



Delancey

Sink



Widespread Faucet
7052807



Widespread Faucet
7052827



Monoblock Faucet
7052107



Monoblock Faucet
7052121



Centerset Faucet
7052207

Bath



Bathtub Faucets
T052901, T052900

Shower



Bath/Shower Trim Kits



Diverter Valve Trim Kits
T052430, T052432



2-Handle Integrated
Shower Diverter Trim Kit
TU052740

Accessories



Delancey
18" Towel Bar
7052018



Delancey
24" Towel Bar
7052024







Delancey
Towel Ring
7052190





Delancey
Toilet Paper Holder
7052230



Delancey
Double Robe Hook
7052210

	Description	SKU #	Color/Finish	List Price
	Delancey® 8-Inch Widespread 2-Handle Bathroom Faucet 1.2 gpm/4.5 L/min With Lever Handles <ul style="list-style-type: none"> • Zinc body construction • Washerless ceramic disc valve cartridges • Valve bodies with integrated flexible hose connections for 6"-12" (152-305mm) installation • Water-conserving 1.2 gpm/4.5L/min pressure-compensating aerator • Metal lever handles • Brass push pop-up drain 	7052807.002	Polished Chrome	381
		7052807.013	Polished Nickel	533
		7052807.278	Legacy Bronze	570
		7052807.295	Brushed Nickel	533
	Delancey® 8-Inch Widespread 2-Handle Bathroom Faucet 1.2 gpm/4.5 L/min With Cross Handles <ul style="list-style-type: none"> • Zinc body construction • Washerless ceramic disc valve cartridges • Valve bodies with integrated flexible hose connections for 6"-12" (152-305mm) installation • Water-conserving 1.2 gpm/4.5L/min pressure-compensating aerator • Metal cross handles • Brass push pop-up drain 	7052827.002	Polished Chrome	381
		7052827.013	Polished Nickel	533
		7052827.278	Legacy Bronze	570
		7052827.295	Brushed Nickel	533
	Delancey® Single Hole Single-Handle Bathroom Faucet 1.2 gpm/4.5 L/min With Lever Handle <ul style="list-style-type: none"> • Brass construction • Washerless ceramic disc valve cartridges • Water-conserving 1.2 gpm/4.5 L/min pressure-compensating aerator • Cast brass spout • Metal lever handle • Braided flexible hoses with 3/8" (10 mm) compression connectors • Brass push pop-up drain 	7052107.002	Polished Chrome	288
		7052107.013	Polished Nickel	405
		7052107.278	Legacy Bronze	432
		7052107.295	Brushed Nickel	405
	Delancey® Single Hole Single-Handle Bathroom Faucet 1.2 gpm/4.5 L/min With Lever Handle <ul style="list-style-type: none"> • Brass construction • Washerless ceramic disc valve cartridges • Water-conserving 1.2 gpm/4.5 L/min pressure-compensating aerator • Cast brass spout • Metal lever handle • Braided flexible hoses with 3/8" (10 mm) compression connectors • Brass push pop-up drain 	7052121.002	Polished Chrome	330
		7052121.013	Polished Nickel	460
		7052121.278	Legacy Bronze	494
		7052121.295	Brushed Nickel	460
	Universal Deck Plate <ul style="list-style-type: none"> • Metal construction • Putty plate included 	2000102P.002	Polished Chrome	50
		2000102P.013	Polished Nickel	70
		2000102P.278	Legacy Bronze	76
		2000102P.295	Brushed Nickel	70

	Description	SKU #	Color/Finish	List Price
 	Delancey® 4-Inch Centerset 2-Handle Bathroom Faucet 1.2gpm/4.5 L/min With Lever Handles <ul style="list-style-type: none"> • Brass construction • Washerless ceramic disc valve cartridges • Water-conserving 1.2 gpm/4.5 L/min pressure-compensating aerator • Cast brass spout • Metal lever handles • Brass push pop-up drain • Durable metal construction 	 7052207.002	Polished Chrome	261
		 7052207.013	Polished Nickel	364
		7052207.278	Legacy Bronze	389
		7052207.295	Brushed Nickel	364
			 	
	Delancey® Bathtub Faucet With Lever Handles and Personal Shower for Flash® Rough-In Valve <ul style="list-style-type: none"> • Brass construction • All personal showers feature 5' (152 cm) long hose • Metal lever handles • With personal shower • For use with Flash® bathtub faucet rough-in valve R910 	 T052901.002	Polished Chrome	485
		T052901.013	Polished Nickel	678
		T052901.278	Legacy Bronze	726
		T052901.295	Brushed Nickel	678
			  	
 	Delancey® Bathtub Faucet With Lever Handles for Flash® Rough-In Valve <ul style="list-style-type: none"> • Brass construction • Metal lever handles • Less personal shower • For use with Flash® bathtub faucet rough-in valve R900 	 T052900.002	Polished Chrome	347
		T052900.013	Polished Nickel	485
		T052900.278	Legacy Bronze	519
		T052900.295	Brushed Nickel	485
			  	
	Flash® Bathtub Filler Rough-In Valve With Personal Shower <ul style="list-style-type: none"> • Brass construction and washerless ¼-turn ceramic disc valves cartridge • ½" (13 mm) copper inlets • Connections to spout can be made via flexible hoses (provided) or ½" (13 mm) copper sweat connections • 14 gpm/59.2 L/min maximum flow rate at 40 psi • 8"-16" (203-406 mm) flexible installation • Adjustable rough-in: 2-½" (64 mm) maximum deck thickness • Includes hand shower rough-in 	R910	No Finish	322
				
	Flash® Bathtub Filler Rough-In Valve <ul style="list-style-type: none"> • Brass construction and washerless ¼-turn ceramic disc valve cartridges • ½" (13 mm) copper inlets • Connections to spout can be made via flexible hoses (provided) or ½" (13 mm) copper sweat connections • 14 gpm/52.9 L/min maximum flow rate at 40 psi • 8"-16" (203-406 mm) flexible installation • Adjustable rough-in: 2-½" (64 mm) maximum deck thickness 	R900	No Finish	184
				

Delancey

HOW TO ORDER

Choose desired trim kit.



Trim kit with cartridge



Choose rough-in valve with desired connection.

















Flash® Shower Rough-In Valve



Fully installed Bath/Shower



	Description	SKU #	Color/Finish	List Price
	Delancey® 1.8 gpm/6.8 L/min Tub and Shower Trim Kit With Water-Saving 4-Function Showerhead and Lever Handle <ul style="list-style-type: none"> • Showerhead with 1.8 gpm/6.8 L/min maximum flow • Water-saving 4-function showerhead • Shower arm and flange • Wall escutcheon • Metal lever handle • Metal slip-on diverter tub spout • For use with Flash® shower rough-in valves 	 TU052508.002	Polished Chrome	288
		TU052508.013	Polished Nickel	405
		TU052508.278	Legacy Bronze	432
		TU052508.295	Brushed Nickel	405
				
	Delancey® 1.8 gpm/6.8 L/min Shower Trim Kit With Water-Saving 4-Function Showerhead and Lever Handle <ul style="list-style-type: none"> • Showerhead with 1.8 gpm/6.8 L/min maximum flow • Water-saving 4-function showerhead • Shower arm and flange • Wall escutcheon • Metal lever handle • For use with Flash® shower rough-in valves 	 TU052507.002	Polished Chrome	248
		TU052507.013	Polished Nickel	348
		TU052507.278	Legacy Bronze	373
		TU052507.295	Brushed Nickel	348
				
	Delancey® Valve Only Trim Kit With Lever Handle <ul style="list-style-type: none"> • Wall escutcheon • Metal lever handle • For uses with Flash® shower rough-in valves 	 TU052500.002	Polished Chrome	201
		TU052500.013	Polished Nickel	283
		TU052500.278	Legacy Bronze	304
		TU052500.295	Brushed Nickel	283
				

	Description	SKU #	Color/Finish	List Price
	<p>Flash® Shower Rough-In Valve With Universal Inlets/Outlets</p> <ul style="list-style-type: none"> • ½" (13 mm) male NPT/Sweat inlets/outlets accept ½" copper, ½" iron pipe, PEX or CPVC adapters • Cast DZR brass valve body • Flow rate: 5.1 gpm @ 45 psi* • Back-to-back capability • Includes flush plug with stainless steel ring • Cartridge ships with trim • For use with TU series pressure balance bath/shower trim kits 	RU101	No Finish	72
	<p>Flash® Shower Rough-In Valve With Universal Inlets/Outlets With Screwdriver Stops</p> <ul style="list-style-type: none"> • ½" (13 mm) male NPT/Sweat inlets/outlets accept ½" copper, ½" iron pipe, PEX or CPVC adapters • Cast DZR brass valve body • Flow rate: 5.1 gpm @ 45 psi* • Back-to-back capability • Includes flush plug with stainless steel ring • Includes screwdriver stops for easy servicing at the valve • For use with TU series pressure balance bath/shower trim kits 	RU101SS	No Finish	103
	<p>Flash® Shower Rough-In Valve With Stub-Outs</p> <ul style="list-style-type: none"> • ½" (13 mm) Stub-out inlets/outlets accept ½" press-connect fittings • Cast DZR brass valve body • Flow rate: 5.1 gpm @ 45 psi* • Back-to-back capability • Includes flush plug with stainless steel ring • Cartridge ships with trim • For use with TU series pressure balance bath/shower trim kits 	RU102	No Finish	72
	<p>Flash® Shower Rough-In Valve With Stub-Outs With Screwdriver Stops</p> <ul style="list-style-type: none"> • ½" (13 mm) Stub-out inlets/outlets accept ½" press-connect fittings • Cast DZR brass valve body • Flow rate: 5.1 gpm @ 45 psi* • Back-to-back capability • Includes flush plug with stainless steel ring • Includes screwdriver stops for easy servicing at the valve • Cartridge ships with trim • For use with TU series pressure balance bath/shower trim kits 	RU102SS	No Finish	103
	<p>Flash® Shower Rough-In Valve With PEX Inlets/Universal Outlets for Crimp Ring System</p> <ul style="list-style-type: none"> • ½" (3 mm) PEX crimp inlets/Universal outlets (ASTM F1807) • Cast DZR brass valve body • Flow rate: 5.1 gpm @ 45 psi* • Back-to-back capability • Includes flush plug with stainless steel ring • Cartridge ships with trim • For use with TU series pressure balance bath/shower trim kits 	RU107	No Finish	72





*When combined with Double Ceramic pressure balance cartridge.













	Description	SKU #	Color/Finish	List Price	
	<p>Flash® Shower Rough-In Valve With PEX Inlets/Universal Outlets With Screwdriver Stops for Crimp Ring System</p> <ul style="list-style-type: none"> • ½" (13 mm) PEX crimp inlets/Universal outlets (ASTM F1807) • Cast DZR brass valve body • Flow rate: 5.1 gpm @ 45 psi* • Back-to-back capability • Includes flush plug with stainless steel ring • Includes screwdriver stops for easy servicing at the valve • Cartridge ships with trim • For use with TU series pressure balance bath/shower trim kits 	RU107SS	No Finish	103	
		<p>Flash® Shower Rough-In Valve With PEX Inlet Elbows/Universal Outlets for Crimp Ring System</p> <ul style="list-style-type: none"> • ½" (13 mm) PEX crimp elbow inlets/Universal outlets (ASTM F1807) • Cast DZR brass valve body • Flow rate: 5.1 gpm @ 45 psi* • Back-to-back capability • Includes flush plug with stainless steel ring • Cartridge ships with trim • For use with TU series pressure balance bath/shower trim kits 	RU107E	No Finish	95
		<p>Flash® Shower Rough-In Valve With PEX Inlet Elbows/Universal Outlets With Screwdriver Stops for Crimp Ring System</p> <ul style="list-style-type: none"> • ½" (13 mm) PEX crimp elbow inlets/Universal outlets (ASTM F1807) • Cast DZR brass valve body • Flow rate: 5.1 gpm @ 45 psi* • Back-to-back capability • Includes flush plug with stainless steel ring • Includes screwdriver stops for easy servicing at the valve • Cartridge ships with trim • For use with TU series pressure balance bath/shower trim kits 	RU107ESS	No Finish	125
		<p>Flash® Shower Rough-In Valve With PEX Inlets/Universal Outlets for Cold Expansion System</p> <ul style="list-style-type: none"> • ½" (13 mm) PEX cold expansion inlets/Universal outlets (ASTM F1960) • Cast DZR brass valve body • Flow rate: 5.1 gpm @ 45 psi* • Back-to-back capability • Includes flush plug with stainless steel ring • Cartridge ships with trim • For use with TU series pressure balance bath/shower trim kits 	RU108	No Finish	72
		<p>Flash® Shower Rough-In Valve With PEX Inlets/Universal Outlets With Screwdriver Stops for Cold Expansion System</p> <ul style="list-style-type: none"> • ½" (13 mm) PEX cold expansion inlets/Universal outlets (ASTM F1960) • Cast DZR brass valve body • Flow rate: 5.1 gpm @ 45 psi* • Back-to-back capability • Includes flush plug with stainless steel ring • Includes screwdriver stops for easy servicing at the valve • For use with TU series pressure balance bath/shower trim kits 	RU108SS	No Finish	103
					

*When combined with Double Ceramic pressure balance cartridge.

	Description	SKU #	Color/Finish	List Price
	<p>Flash® Shower Rough-In Valve With PEX Inlet Elbows/Universal Outlets for Cold Expansion System</p> <ul style="list-style-type: none"> • ½" (13 mm) PEX cold expansion elbow inlets/ Universal outlets (ASTM F1960) • Cast DZR brass valve body • Flow rate: 5.1 gpm @ 45 psi* • Back-to-back capability • Includes flush plug with stainless steel ring • Cartridge ships with trim • For use with TU series pressure balance bath/ shower trim kits 	RU108E	No Finish	95 
	<p>Flash® Shower Rough-In Valve With PRX Inlet Elbows/Universal Outlets With Screwdriver Stops for Cold Expansion System</p> <ul style="list-style-type: none"> • ½" (13 mm) PEX cold expansion elbow inlets/ Universal outlets (ASTM F1960) • Cast DZR brass valve body • Flow rate: 5.1 gpm @ 45 psi* • Back-to-back capability • Includes flush plug with stainless steel ring • Includes screwdriver stops for easy servicing at the valve • Cartridge ships with trim • For use with TU series pressure balance bath/ shower trim kits 	RU108ESS	No Finish	125 
	<p>Flash® Shower Rough-In Valve With CPVC Inlets/Universal Outlets</p> <ul style="list-style-type: none"> • ½" (13 mm) CPVC inlets/Universal outlets • Cast DZR brass valve body • Flow rate: 5.1 gpm @ 45 psi* • Back-to-back capability • Includes flush plug with stainless steel ring • Cartridge ships with trim • For use with TU series pressure balance bath/ shower trim kits 	RU109	No Finish	95 
	<p>Flash® Shower Rough-In Valve With CPVC Inlets/Universal Outlets With Screwdriver Stops</p> <ul style="list-style-type: none"> • ½" (13 mm) CPVC inlets/Universal outlets • Cast DZR brass valve body • Flow rate: 5.1 gpm @ 45 psi* • Back-to-back capability • Includes flush plug with stainless steel ring • Includes screwdriver stops for easy servicing at the valve • Cartridge ships with trim • For use with TU series pressure balance bath/ shower trim kits 	RU109SS	No Finish	125 

*When combined with Double Ceramic pressure balance cartridge.

	Description	SKU #	Color/Finish	List Price
	Delancey® 2-Handle Integrated Shower Diverter Trim Only		TU052740.002 Polished Chrome	252
			TU052740.013 Polished Nickel	353
			TU052740.278 Legacy Bronze	378
			TU052740.295 Brushed Nickel	353
	<ul style="list-style-type: none"> • Metal wall escutcheon • Metal lever handles • Works with Flash® 2-Way Integrated Shower Diverter Rough-In Valve with Pressure Balance Valve Cartridge, required and sold separately • Flash® 2-Way Integrated Shower Diverter Rough-In Valve RU521 ships with a 2-way Discrete cartridge • 2-Way Shared capability requires Flash® 2-Way Integrated Shower Diverter Rough-In Valve RU521, plus a 2-Way Shared pressure balance cartridge #M970720-0070A, sold separately • Flash® 3-Way Integrated Shower Diverter Rough-In Valve RU531 ships with a 3-Way Discrete cartridge • 3-Way Shared capability requires Flash® 3-Way Integrated Shower Diverter Rough-In Valve RU531, plus a 3-Way Shared pressure balance cartridge #M970730-0070A, sold separately • 3-way diverter with shared flow requires cartridge M970730-0070A (sold separately) 			
Flash® 2-Way Integrated Shower Diverter Rough-In Valve with Pressure Balance Valve Cartridge	RU521	No Finish		355
	<ul style="list-style-type: none"> • Made of casted DZR brass to resist corrosion • For use with Flash® 2-Handle Integrated Shower Diverter Trim • ½" NPT Inlets/Outlets • Valve ships with a 2-Way Discrete pressure balance cartridge • 2-Way Shared functionality requires RU521 valve, plus purchase of 2-Way Shared cartridge RP# M970720-0070A, sold separately • Compatible with Delancey®, Serin®, Studio® S, Town Square® S, Times Square® and Townsend® trims • Trim sold separately 			
	Flash® 2-Way Shared Diverter Cartridge			M970720-0070A
	<ul style="list-style-type: none"> • For use with RU521 valve 			
	Flash® 3-Way Integrated Shower Diverter Rough-In Valve with Pressure Balance Valve Cartridge	RU531	No Finish	385
	<ul style="list-style-type: none"> • Made of casted DZR brass to resist corrosion • For use with Flash® 2-Handle Integrated Shower Diverter Trim • ½" NPT Inlets/Outlets • Valve ships with a 3-Way Discrete pressure balance cartridge • 3-Way Shared functionality requires RU531 valve, plus purchase of 3-Way Shared cartridge RP# M970730-0070A, sold separately • Compatible with Delancey®, Serin®, Studio® S, Town Square® S, Times Square® and Townsend® trims • Trim sold separately 			
Flash® 3-Way Shared Diverter Cartridge	M970730-0070A		No Finish	79
	<ul style="list-style-type: none"> • For use with RU531 valve 			

	Description	SKU #	Color/Finish	List Price
	Delancey® Single-Handle Diverter Valve Trim Kit With Lever Handle • Metal lever handle • Less valve (must be purchased separately) • For use with rough-in valves R422, R422S, R433 and R433S	ADA T052430.002	Polished Chrome	117
		T052430.013	Polished Nickel	162
		T052430.278	Legacy Bronze	174
		T052430.295	Brushed Nickel	162
				
	Delancey® Single-Handle Diverter Valve Trim Kit With Cross Handle • Metal cross handle • Less valve (must be purchased separately) • For use with rough-in valves R422, R422S, R433 and R433S	ADA T052432.002	Polished Chrome	117
		T052432.013	Polished Nickel	162
		T052432.278	Legacy Bronze	174
		T052432.295	Brushed Nickel	162
				
	2-Way In-Wall Diverter Rough-In Valve With 2 Discrete Functions • Durable cast brass valve body – excellent for high use applications with prolonged water use • Controls water flow between 2 outlets (shower or sprays) • ½" (13 mm) NPT inlets/outlets • Trim must be ordered separately	R422	No Finish	231
				
	2-Way In-Wall Diverter Rough-In Valve With 2 Discrete/1 Shared Function • Durable cast brass valve body – excellent for high use applications with prolonged water use • Controls water flow between 2 outlets (shower or sprays) • ½" (13 mm) NPT inlets/outlets • Trim must be ordered separately	R422S	No Finish	231
				
	3-Way In-Wall Diverter Rough-In Valve With 3 Discrete Functions • Durable cast brass valve body – excellent for high use applications with prolonged water use • Controls water flow between 3 outlets (shower or sprays) • ½" (13 mm) NPT inlets/outlets • Trim must be ordered separately	R433	No Finish	262
				
	3-Way In-Wall Diverter Rough-In Valve With 3 Discrete/3 Shared Functions • Durable cast brass valve body – excellent for high use applications with prolonged water use • Controls water flow between 3 outlets (shower or sprays) • ½" (13 mm) NPT inlets/outlets • Trim must be ordered separately	R433S	No Finish	262
				

Delancey Flash® Pressure Balance Bath/Shower System

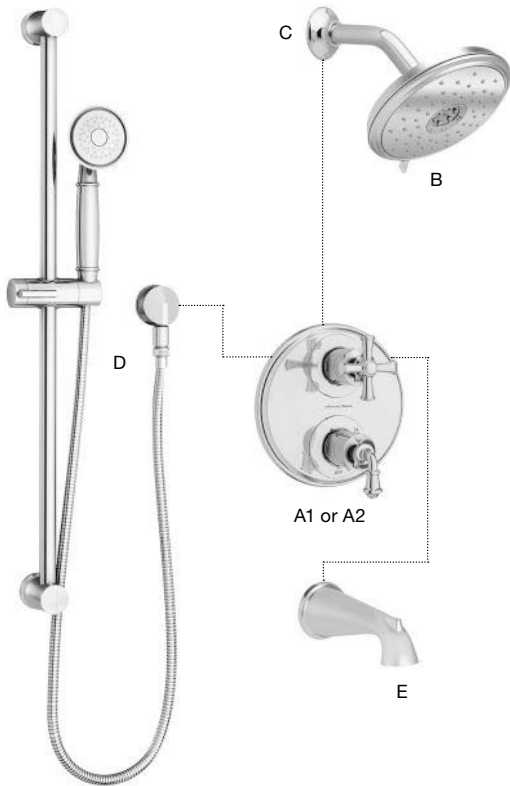

Delancey Flash Pressure Balance Shower System

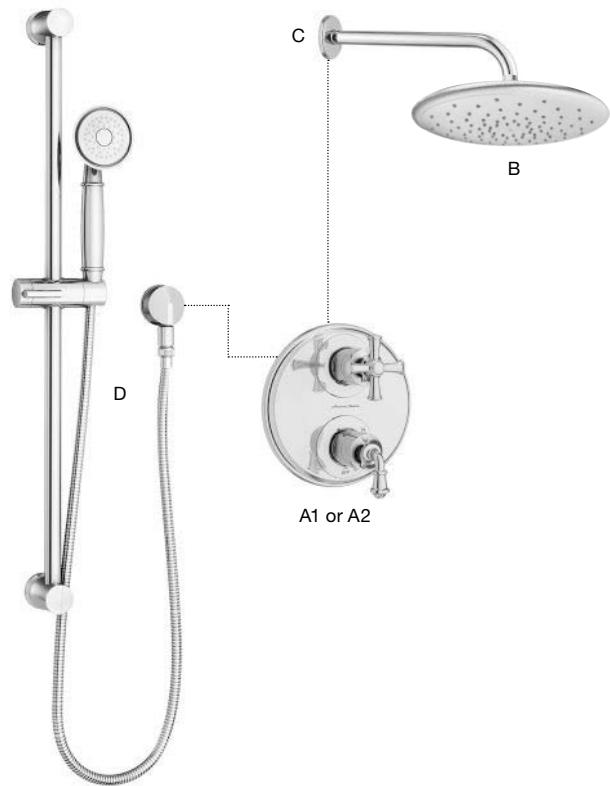

Delancey Flash® Pressure Balance Bath/Shower System

Description	Qty	SKU #	List Price For System
			002
A Delancey Flash 2-Handle Integrated Shower Diverter Trim	1	TU052740	252
B Spectra Fixed® Traditional Showerhead	1	9138073	111
C Standard Shower Arm	1	1660240	29
D Traditional Slide Bar Kit	1	1662607	432
E Delancey Tub Spout	1	8888107	99

Required Components – Choose From Rough-In Valve 1 or 2 (not shown)















1	3-Way Discrete (Non-Shared) Functionality – Requires Flash 3-Way Integrated Shower Diverter Rough-In Valve with Pressure Balance Valve Cartridge	1	RU531	385
2	3-Way (Shared) Functionality – Requires Flash 3-Way Integrated Shower Diverter Rough-In Valve with Pressure Balance Valve Cartridge, also requires 3-way shared function cartridge M970730-0070A (sold separately)	1	RU531 + M970730-0070A	385 + 79 = 464
			3-Way Discrete (Non-Shared) Bath/Shower System Total	1,308
			3-Way (Shared) Bath/Shower System Total	1,387

Delancey Flash Pressure Balance Shower System

Description	Qty	SKU #	List Price For System
			002
A Delancey Flash 2-Handle Integrated Shower Diverter Trim	1	TU052740	252
B Spectra Rain® Showerhead	1	9038001	197
C 12" Wall-Mount Right Angle Rain Showerhead Arm	1	1660194	101
D Traditional Slide Bar Kit	1	1662607	432

Required Components – Choose From Rough-In Valve 1 or 2 (not shown)

1	2-Way Discrete (Non-Shared) Functionality – Requires Flash 2-Way Integrated Shower Diverter Rough-In Valve with Pressure Balance Valve Cartridge	1	RU521	355
2	2-Way (Shared) Functionality – Requires Flash 2-Way Integrated Shower Diverter Rough-In Valve with Pressure Balance Valve Cartridge, also requires 2-way shared function cartridge M970720-0070A (sold separately)	1	RU521 + M970720-0070A	355 + 79 = 434
			2-Way Discrete (Non-Shared) Bath/Shower System Total	1,337
			2-Way (Shared) Bath/Shower System Total	1,416

	Description	SKU #	Color/Finish	List Price
	Delancey® 18-Inch Towel Bar	7052018.002	Polished Chrome	76
	• Brass bar	7052018.013	Polished Nickel	105
	• All metal construction	7052018.278	Legacy Bronze	113
	• Concealed mounting: no exposed set screws	7052018.295	Brushed Nickel	105
	• Coordinates with Delancey® bath faucet collection			
	• Limited lifetime warranty on function and finish			
				 
	Delancey® 24-Inch Towel Bar	7052024.002	Polished Chrome	82
	• Brass bar	7052024.013	Polished Nickel	113
	• All metal construction	7052024.278	Legacy Bronze	122
	• Concealed mounting: no exposed set screws	7052024.295	Brushed Nickel	113
	• Coordinates with Delancey® bath faucet collection			
	• Limited lifetime warranty on function and finish			
				 
	Delancey® Towel Ring	7052190.002	Polished Chrome	47
	• 7-1/4" (185 mm) diameter ring	7052190.013	Polished Nickel	65
	• All metal construction	7052190.278	Legacy Bronze	70
	• Concealed mounting: no exposed set screws	7052190.295	Brushed Nickel	65
	• Coordinates with Delancey® bath faucet collection			
	• Bushing on towel ring to prevent scratching and squeaking			
	• Limited lifetime warranty on function and finish			
				 
	Delancey® Double Robe Hook	7052210.002	Polished Chrome	35
	• All metal construction	7052210.013	Polished Nickel	49
	• Concealed mounting: no exposed set screws	7052210.278	Legacy Bronze	52
	• Coordinates with Delancey® bath faucet collection	7052210.295	Brushed Nickel	49
	• Easy to install			
	• Limited lifetime warranty on function and finish			
	• Solid metal construction is durable and long-lasting			
				 
	Delancey® Toilet Paper Holder	7052230.002	Polished Chrome	64
	• All metal construction	7052230.013	Polished Nickel	89
	• Concealed mounting: no exposed set screws	7052230.278	Legacy Bronze	96
	• Coordinates with Delancey® bath faucet collection	7052230.295	Brushed Nickel	89
	• Easy to install			
	• Limited lifetime warranty on function and finish			
				 

Elevate your bathroom with the stately beauty of the **Edgemere Collection**. This striking style enhances traditional, transitional, and contemporary settings beautifully.



Edgemere

Sink



Widespread Faucet
7018801



Monoblock Faucet
7018101



Centerset Faucet
7018201

Bath



Bathtub Faucets
T018901, T018900

Shower



Bath/Shower Trim Kits
TU018502, TU018508

Accessories



Edgemere
18" Towel Bar
7018018



Edgemere
24" Towel Bar
7018024







Edgemere
Towel Ring
7018190













Edgemere
Toilet Paper Holder
7018230









Edgemere
Double Robe Hook
7018210











	Description	SKU #	Color/Finish	List Price
	Edgemere® 8-Inch Widespread 2-Handle Bathroom Faucet 1.2 gpm/4.5 L/min With Lever Handles <ul style="list-style-type: none"> • ¼-turn ceramic disc valve cartridges • Water-conserving 1.2 gpm/4.5 L/min pressure-compensating aerator • Cast spout • Cast brass valve bodies with flexible hose connections for 6"-12" (152-305 mm) installation • 24" (610 mm) braided flexible supply hose with 3/8" (10 mm) compression connectors • Metal lever handles • Metal Speed Connect® pop-up drain 	7018801.002	Polished Chrome	361
		7018801.243	Matte Black	524
		7018801.278	Legacy Bronze	542
		7018801.295	Brushed Nickel	506
	Edgemere® Single Hole Single-Handle Bathroom Faucet 1.2 gpm/4.5 L/min With Lever Handle <ul style="list-style-type: none"> • All metal construction • Water-conserving 1.2 gpm/4.5 L/min pressure-compensating aerator • 24" (610 mm) braided flexible supply hose with 3/8" (10 mm) compression connectors • Adjustable Hot Limit Safety Stop • Red/Blue and color-matched index buttons included • Metal lever handle • Metal Speed Connect® pop-up drain 	7018101.002	Polished Chrome	271
		7018101.243	Matte Black	393
		7018101.278	Legacy Bronze	407
		7018101.295	Brushed Nickel	379
	Edgemere® 4-Inch Centerset 2-Handle Bathroom Faucet 1.2 gpm/4.5 L/min With Lever Handles <ul style="list-style-type: none"> • ¼-turn ceramic disc valve cartridges • Water-conserving 1.2 gpm/4.5 L/min pressure-compensating aerator • Cast brass body • Metal lever handles • Metal Speed Connect® pop-up drain 	7018201.002	Polished Chrome	241
		7018201.243	Matte Black	349
		7018201.278	Legacy Bronze	361
		7018201.295	Brushed Nickel	338
	Edgemere® Deck Plate <ul style="list-style-type: none"> • Metal construction • Putty plate included 	7018101P.002	Polished Chrome	46
		7018101P.278	Legacy Bronze	67
		7018101P.295	Brushed Nickel	63
	Edgemere® Bathtub Faucet With Lever Handles and Personal Shower for Flash® Rough-In Valve <ul style="list-style-type: none"> • Brass construction • All personal showers feature 5' (152 cm) long hose • Metal lever handles • With personal shower • For use with Flash® bathtub faucet rough-in valve R910 • Washerless ¼-turn ceramic disc valve cartridges • Durable brass spout • Trim kit provides an additional 1" installation adjustability for finished deck 	7018901.002	Polished Chrome	664
		7018901.243	Matte Black	962
		7018901.278	Legacy Bronze	993
		7018901.295	Brushed Nickel	928

	Description	SKU #	Color/Finish	List Price
	<p>Edgemere® Bathtub Faucet With Lever Handles for Flash® Rough-In Valve</p> <ul style="list-style-type: none"> • Brass construction • Metal lever handles • Less personal shower • For use with Flash® bathtub faucet rough-in valve R900 • Washerless ¼-turn ceramic disc valve cartridges • Durable brass spout • Trim kit provides an additional 1" installation adjustability for finished deck 	 T018900.002	Polished Chrome	482
		T018900.278	Legacy Bronze	722
		T018900.295	Brushed Nickel	674
				
	<p>Flash® Bathtub Filler Rough-In Valve With Personal Shower</p> <ul style="list-style-type: none"> • Brass construction and washerless ¼-turn ceramic disc valves cartridge • ½" (13 mm) copper inlets • Connections to spout can be made via flexible hoses (provided) or ½" (13 mm) copper sweat connections • 14 gpm/59.2 L/min maximum flow rate at 40 psi • 8"-16" (203-406 mm) flexible installation • Adjustable rough-in: 2-½" (64 mm) maximum deck thickness • Includes hand shower rough-in 	R910	No Finish	322
				
	<p>Flash® Bathtub Filler Rough-In Valve</p> <ul style="list-style-type: none"> • Brass construction and washerless ¼-turn ceramic disc valve cartridges • ½" (13 mm) copper inlets • Connections to spout can be made via flexible hoses (provided) or ½" (13 mm) copper sweat connections • 14 gpm/52.9 L/min maximum flow rate at 40 psi • 8"-16" (203-406 mm) flexible installation • Adjustable rough-in: 2-½" (64 mm) maximum deck thickness 	R900	No Finish	184
				

	Description	SKU #	Color/Finish	List Price
	Edgemere® 2.5 gpm/9.5 L/min Tub and Shower Trim Kit With Showerhead, Double Ceramic Pressure Balance Cartridge With Lever Handle <ul style="list-style-type: none"> • Includes Double Ceramic pressure balance cartridge • 5-¾" (147 mm) showerhead, 2.5 gpm/9.5 L/min maximum flow • Shower arm and flange • Wall escutcheon • Metal lever handle • Metal slip-on diverter tub spout • For use with Flash® shower rough-in valves 	TU018502.002	Polished Chrome	253
		TU018502.278	Legacy Bronze	366
		TU018502.295	Brushed Nickel	345
	Edgemere® 2.5 gpm/9.5 L/min Shower Trim Kit With Showerhead, Double Ceramic Pressure Balance Cartridge With Lever Handle <ul style="list-style-type: none"> • Includes Double Ceramic pressure balance cartridge • 5-¾" (147 mm) showerhead, 2.5 gpm/9.5 L/min maximum flow • Shower arm and flange • Wall escutcheon • Metal lever handle • For use with Flash® shower rough-in valves 	TU018501.002	Polished Chrome	229
		TU018501.278	Legacy Bronze	328
		TU018501.295	Brushed Nickel	307
	Edgemere® Valve Only Trim With Double Ceramic Pressure Balance Cartridge With Lever Handle <ul style="list-style-type: none"> • Includes Double Ceramic pressure balance cartridge • Wall escutcheon • Metal lever handle • For use with Flash® shower rough-in valves 	TU018500.002	Polished Chrome	200
		TU018500.243	Matte Black	290
		TU018500.278	Legacy Bronze	288
		TU018500.295	Brushed Nickel	271
	Edgemere® 1.8 gpm/6.8 L/min Tub and Shower Trim Kit With Water-Saving Showerhead, Double Ceramic Pressure Balance Cartridge With Lever Handle <ul style="list-style-type: none"> • Includes Double Ceramic pressure balance cartridge • Water-saving 5-¾" (147 mm) showerhead, 1.8 gpm/6.8 L/min maximum flow • Shower arm and flange • Wall escutcheon • Metal lever handle • Metal slip-on diverter tub spout • For use with Flash® shower rough-in valves 	TU018508.002	Polished Chrome	253
		TU018508.243	Matte Black	368
		TU018508.278	Legacy Bronze	366
		TU018508.295	Brushed Nickel	345











	Description	SKU #	Color/Finish	List Price
 	Edgemere® 1.8 gpm/6.8 L/min Shower Trim Kit With Water-Saving Showerhead, Double Ceramic Pressure Balance Cartridge With Lever Handle	 TU018507.002	Polished Chrome	229
		 TU018507.243	Matte Black	332
	<ul style="list-style-type: none"> • Includes Double Ceramic pressure balance cartridge 	TU018507.278	Legacy Bronze	328
	<ul style="list-style-type: none"> • Water-saving 5-3/4" (147 mm) showerhead, 1.8 gpm/6.8 L/min maximum flow • Shower arm and flange • Wall escutcheon • Metal lever handle • For use with Flash® shower rough-in valves 	TU018507.295	Brushed Nickel	307
			  	

	Description	SKU #	Color/Finish	List Price
	<p>Flash® Shower Rough-In Valve With Universal Inlets/Outlets</p> <ul style="list-style-type: none"> • ½" (13 mm) male NPT/Sweat inlets/outlets accept ½" copper, ½" iron pipe, PEX or CPVC adapters • Cast DZR brass valve body • Flow rate: 5.1 gpm @ 45 psi* • Back-to-back capability • Includes flush plug with stainless steel ring • Cartridge ships with trim • For use with TU series pressure balance bath/shower trim kits 	RU101	No Finish	72 
	<p>Flash® Shower Rough-In Valve With Universal Inlets/Outlets With Screwdriver Stops</p> <ul style="list-style-type: none"> • ½" (13 mm) male NPT/Sweat inlets/outlets accept ½" copper, ½" iron pipe, PEX or CPVC adapters • Cast DZR brass valve body • Flow rate: 5.1 gpm @ 45 psi* • Back-to-back capability • Includes flush plug with stainless steel ring • Includes screwdriver stops for easy servicing at the valve • For use with TU series pressure balance bath/shower trim kits 	RU101SS	No Finish	103 
	<p>Flash® Shower Rough-In Valve With Stub-Outs</p> <ul style="list-style-type: none"> • ½" (13 mm) Stub-out inlets/outlets accept ½" press-connect fittings • Cast DZR brass valve body • Flow rate: 5.1 gpm @ 45 psi* • Back-to-back capability • Includes flush plug with stainless steel ring • Cartridge ships with trim • For use with TU series pressure balance bath/shower trim kits 	RU102	No Finish	72 
	<p>Flash® Shower Rough-In Valve With Stub-Outs With Screwdriver Stops</p> <ul style="list-style-type: none"> • ½" (13 mm) Stub-out inlets/outlets accept ½" press-connect fittings • Cast DZR brass valve body • Flow rate: 5.1 gpm @ 45 psi* • Back-to-back capability • Includes flush plug with stainless steel ring • Includes screwdriver stops for easy servicing at the valve • Cartridge ships with trim • For use with TU series pressure balance bath/shower trim kits 	RU102SS	No Finish	103 
	<p>Flash® Shower Rough-In Valve With PEX Inlets/Universal Outlets for Crimp Ring System</p> <ul style="list-style-type: none"> • ½" (3 mm) PEX crimp inlets/Universal outlets (ASTM F1807) • Cast DZR brass valve body • Flow rate: 5.1 gpm @ 45 psi* • Back-to-back capability • Includes flush plug with stainless steel ring • Cartridge ships with trim • For use with TU series pressure balance bath/shower trim kits 	RU107	No Finish	72 

*When combined with Double Ceramic pressure balance cartridge.





	Description	SKU #	Color/Finish	List Price
	<p>Flash® Shower Rough-In Valve With PEX Inlets/Universal Outlets With Screwdriver Stops for Crimp Ring System</p> <ul style="list-style-type: none"> • ½" (13 mm) PEX crimp inlets/Universal outlets (ASTM F1807) • Cast DZR brass valve body • Flow rate: 5.1 gpm @ 45 psi* • Back-to-back capability • Includes flush plug with stainless steel ring • Includes screwdriver stops for easy servicing at the valve • Cartridge ships with trim • For use with TU series pressure balance bath/shower trim kits 	RU107SS	No Finish	103 
	<p>Flash® Shower Rough-In Valve With PEX Inlet Elbows/Universal Outlets for Crimp Ring System</p> <ul style="list-style-type: none"> • ½" (13 mm) PEX crimp elbow inlets/Universal outlets (ASTM F1807) • Cast DZR brass valve body • Flow rate: 5.1 gpm @ 45 psi* • Back-to-back capability • Includes flush plug with stainless steel ring • Cartridge ships with trim • For use with TU series pressure balance bath/shower trim kits 	RU107E	No Finish	95 
	<p>Flash® Shower Rough-In Valve With PEX Inlet Elbows/Universal Outlets With Screwdriver Stops for Crimp Ring System</p> <ul style="list-style-type: none"> • ½" (13 mm) PEX crimp elbow inlets/Universal outlets (ASTM F1807) • Cast DZR brass valve body • Flow rate: 5.1 gpm @ 45 psi* • Back-to-back capability • Includes flush plug with stainless steel ring • Includes screwdriver stops for easy servicing at the valve • Cartridge ships with trim • For use with TU series pressure balance bath/shower trim kits 	RU107ESS	No Finish	125 
	<p>Flash® Shower Rough-In Valve With PEX Inlets/Universal Outlets for Cold Expansion System</p> <ul style="list-style-type: none"> • ½" (13 mm) PEX cold expansion inlets/Universal outlets (ASTM F1960) • Cast DZR brass valve body • Flow rate: 5.1 gpm @ 45 psi* • Back-to-back capability • Includes flush plug with stainless steel ring • Cartridge ships with trim • For use with TU series pressure balance bath/shower trim kits 	RU108	No Finish	72 
	<p>Flash® Shower Rough-In Valve With PEX Inlets/Universal Outlets With Screwdriver Stops for Cold Expansion System</p> <ul style="list-style-type: none"> • ½" (13 mm) PEX cold expansion inlets/Universal outlets (ASTM F1960) • Cast DZR brass valve body • Flow rate: 5.1 gpm @ 45 psi* • Back-to-back capability • Includes flush plug with stainless steel ring • Includes screwdriver stops for easy servicing at the valve • For use with TU series pressure balance bath/shower trim kits 	RU108SS	No Finish	103 

*When combined with Double Ceramic pressure balance cartridge.

	Description	SKU #	Color/Finish	List Price
	<p>Flash® Shower Rough-In Valve With PEX Inlet Elbows/Universal Outlets for Cold Expansion System</p> <ul style="list-style-type: none"> • ½" (13 mm) PEX cold expansion elbow inlets/ Universal outlets (ASTM F1960) • Cast DZR brass valve body • Flow rate: 5.1 gpm @ 45 psi* • Back-to-back capability • Includes flush plug with stainless steel ring • Cartridge ships with trim • For use with TU series pressure balance bath/ shower trim kits 	RU108E	No Finish	95 
	<p>Flash® Shower Rough-In Valve With PRX Inlet Elbows/Universal Outlets With Screwdriver Stops for Cold Expansion System</p> <ul style="list-style-type: none"> • ½" (13 mm) PEX cold expansion elbow inlets/ Universal outlets (ASTM F1960) • Cast DZR brass valve body • Flow rate: 5.1 gpm @ 45 psi* • Back-to-back capability • Includes flush plug with stainless steel ring • Includes screwdriver stops for easy servicing at the valve • Cartridge ships with trim • For use with TU series pressure balance bath/ shower trim kits 	RU108ESS	No Finish	125 
	<p>Flash® Shower Rough-In Valve With CPVC Inlets/Universal Outlets</p> <ul style="list-style-type: none"> • ½" (13 mm) CPVC inlets/Universal outlets • Cast DZR brass valve body • Flow rate: 5.1 gpm @ 45 psi* • Back-to-back capability • Includes flush plug with stainless steel ring • Cartridge ships with trim • For use with TU series pressure balance bath/ shower trim kits 	RU109	No Finish	95 
	<p>Flash® Shower Rough-In Valve With CPVC Inlets/Universal Outlets With Screwdriver Stops</p> <ul style="list-style-type: none"> • ½" (13 mm) CPVC inlets/Universal outlets • Cast DZR brass valve body • Flow rate: 5.1 gpm @ 45 psi* • Back-to-back capability • Includes flush plug with stainless steel ring • Includes screwdriver stops for easy servicing at the valve • Cartridge ships with trim • For use with TU series pressure balance bath/ shower trim kits 	RU109SS	No Finish	125 

Edgemere

*When combined with Double Ceramic pressure balance cartridge.

	Description	SKU #	Color/Finish	List Price
	Edgemere® 18-Inch Towel Bar	7018018.002	Polished Chrome	66
	• Brass bar	7018018.243	Matte Black	95
	• All metal construction	7018018.278	Legacy Bronze	100
	• Concealed mounting: no exposed set screws	7018018.295	Brushed Nickel	93
	• Coordinates with Edgemere® bath faucet collection			
	• Limited lifetime warranty on function and finish			
				
	Edgemere® 24-Inch Towel Bar	7018024.002	Polished Chrome	74
	• Brass bar	7018024.243	Matte Black	108
	• All metal construction	7018024.278	Legacy Bronze	108
	• Concealed mounting: no exposed set screws	7018024.295	Brushed Nickel	101
	• Coordinates with Edgemere® bath faucet collection			
	• Limited lifetime warranty on function and finish			
				
	Edgemere® Towel Ring	7018190.002	Polished Chrome	49
	• 7-3/4" (185 mm) diameter ring	7018190.243	Matte Black	71
	• All metal construction	7018190.278	Legacy Bronze	74
	• Concealed mounting: no exposed set screws	7018190.295	Brushed Nickel	68
	• Coordinates with Edgemere® bath faucet collection			
	• Limited lifetime warranty on function and finish			
				
	Edgemere® Double Robe Hook	7018210.002	Polished Chrome	36
	• All metal construction	7018210.243	Matte Black	52
	• Concealed mounting: no exposed set screws	7018210.278	Legacy Bronze	54
	• Coordinates with Edgemere® bath faucet collection	7018210.295	Brushed Nickel	51
	• Easy to install			
	• Limited lifetime warranty on function and finish			
	• Solid metal construction is durable and long-lasting			
				
	Edgemere® Toilet Paper Holder	7018230.002	Polished Chrome	54
	• Pivoting arm	7018230.243	Matte Black	78
	• All metal construction	7018230.278	Legacy Bronze	83
	• Coordinates with Edgemere® bath faucet collection	7018230.295	Brushed Nickel	77
	• Easy to install			
	• Limited lifetime warranty on function and finish			
				

Inspired by the continuous movement of water, the **Fluent Collection** adds an easy elegance to your bathroom design. It's the perfect way to bring the beauty of nature indoors.



Sink



Widespread Faucet
7186801



Monoblock Faucet
7186101



Centerset Faucet
7186201

Bath



Bathtub Faucets
T186901, T186900



Tub Spouts

Shower



Bath/Shower Trim Kits
TU186502, TU186508



Diverter Valve Trim Kit
T186430



Showerhead
1660604

Accessories



C Series 18" Towel Bar
8337018



C Series 24" Towel Bar
8337024



C Series Towel Ring
8337190







C Series
Toilet Paper Holder
8337230



C Series
Double Robe Hook
8337210

	Description	SKU #	Color/Finish	List Price
	<p>Fluent® 8-Inch Widespread 2-Handle Bathroom Faucet 1.2 gpm/4.5 L/min With Lever Handles</p> <ul style="list-style-type: none"> • ¼-turn washerless ceramic disc valve cartridges • Water-conserving 1.2 gpm/4.5 L/min pressure-compensating aerator • Cast brass spout • Cast brass valve bodies with flexible hose connections for 6"-12" (152-305 mm) installation • Braided flexible supply hose with 3/8" (10 mm) compression connectors • Metal lever handles • Metal Speed Connect® pop-up drain 	<p>7186801.002 7186801.278 7186801.295</p>	<p>Polished Chrome Legacy Bronze Brushed Nickel</p>	<p>347 519 485</p>
	<p>Fluent® 8-Inch Widespread 2-Handle Bathroom Faucet 1.2 gpm/4.5 L/min With Lever Handles</p> <ul style="list-style-type: none"> • ¼-turn washerless ceramic disc valve cartridges • Water-conserving 1.2 gpm/4.5 L/min pressure-compensating aerator • Cast brass spout • Cast brass valve bodies with flexible hose connections for 6"-12" (152-305 mm) installation • Braided flexible supply hose with 3/8" (10 mm) compression connectors • Metal lever handles with Red/Blue indicators • Metal Speed Connect® pop-up drain 	<p>7186811.002 7186811.278 7186811.295</p>	<p>Polished Chrome Legacy Bronze Brushed Nickel</p>	<p>352 528 494</p>
	<p>Fluent® Single Hole Single-Handle Bathroom Faucet 1.2 gpm/4.5 L/min With Lever Handle</p> <ul style="list-style-type: none"> • ¼-turn washerless ceramic disc valve cartridges • Water-conserving 1.2 gpm/4.5 L/min pressure-compensating aerator • All metal construction • Braided flexible supply hose with 3/8" (10 mm) compression connectors • Adjustable Hot Limit Safety Stop • Red/Blue and finish-matched index buttons included • Metal lever handle • Metal Speed Connect® pop-up drain 	<p>7186101.002 7186101.278 7186101.295</p>	<p>Polished Chrome Legacy Bronze Brushed Nickel</p>	<p>257 383 358</p>
	<p>Universal Deck Plate</p> <ul style="list-style-type: none"> • Metal construction • Putty plate included 	<p>2000102P.002 2000102P.013 2000102P.278 2000102P.295</p>	<p>Polished Chrome Polished Nickel Legacy Bronze Brushed Nickel</p>	<p>50 70 76 70</p>
	<p>Fluent® 4-Inch Centerset 2-Handle Bathroom Faucet 1.2 gpm/4.5 L/min With Lever Handles</p> <ul style="list-style-type: none"> • Brass construction • ¼-turn washerless ceramic disc valve cartridges • Water-conserving 1.2 gpm/4.5 L/min pressure-compensating aerator • Cast brass spout • Metal lever handles • Metal Speed Connect® pop-up drain 	<p>7186201.002 7186201.278 7186201.295</p>	<p>Polished Chrome Legacy Bronze Brushed Nickel</p>	<p>220 331 308</p>

Fluent

	Description	SKU #	Color/Finish	List Price
	<p>Fluent® Bathtub Faucet With Lever Handles and Personal Shower for Flash® Rough-In Valve</p> <ul style="list-style-type: none"> • Brass construction • All personal showers feature 5' (152 cm) long hose • Metal lever handles • Personal shower with 1.8 gpm/6.8 L/min maximum flow • For use with Flash® bathtub faucet rough-in valve R910 • Installs with Flash® rough valve platform 	<p>CEC</p> <p>T186901.002</p> <p>T186901.278</p> <p>T186901.295</p>	<p>Polished Chrome</p> <p>Legacy Bronze</p> <p>Brushed Nickel</p>	<p>651</p> <p>977</p> <p>913</p>
	<p>Fluent® Bathtub Faucet With Lever Handles for Flash® Rough-In Valve</p> <ul style="list-style-type: none"> • Brass construction • Metal lever handles • Less personal shower • For use with Flash® bathtub faucet rough-in valve R900 • Installs with Flash® rough valve platform 	<p>ADA</p> <p>CEC</p> <p>T186900.002</p> <p>T186900.295</p>	<p>Polished Chrome</p> <p>Brushed Nickel</p>	<p>465</p> <p>651</p>
	<p>Flash® Bathtub Filler Rough-In Valve With Personal Shower</p> <ul style="list-style-type: none"> • Brass construction and washerless ¼-turn ceramic disc valves cartridge • ½" (13 mm) copper inlets • Connections to spout can be made via flexible hoses (provided) or ½" (13 mm) copper sweat connections • 14 gpm/59.2 L/min maximum flow rate at 40 psi • 8"-16" (203-406 mm) flexible installation • Adjustable rough-in: 2-½" (64 mm) maximum deck thickness • Includes hand shower rough-in 	<p>R910</p>	<p>No Finish</p>	<p>322</p>
	<p>Flash® Bathtub Filler Rough-In Valve</p> <ul style="list-style-type: none"> • Brass construction and washerless ¼-turn ceramic disc valve cartridges • ½" (13 mm) copper inlets • Connections to spout can be made via flexible hoses (provided) or ½" (13 mm) copper sweat connections • 14 gpm/52.9 L/min maximum flow rate at 40 psi • 8"-16" (203-406 mm) flexible installation • Adjustable rough-in: 2-½" (64 mm) maximum deck thickness 	<p>R900</p>	<p>No Finish</p>	<p>184</p>

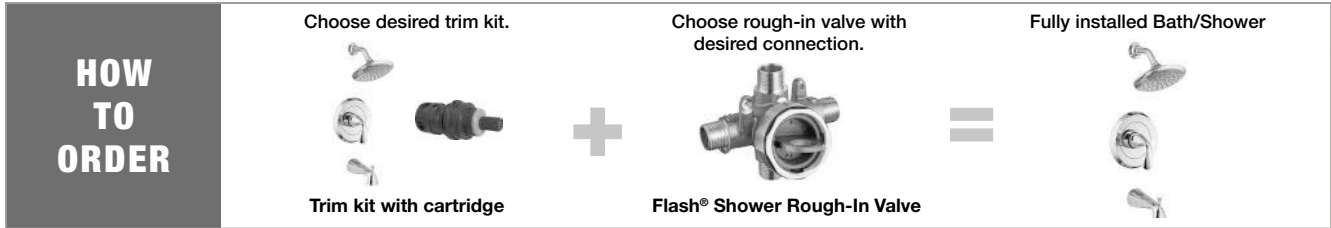

Description	SKU #	Color/Finish	List Price
-------------	-------	--------------	------------



Fluent® 2.5 gpm/9.5 L/min Tub and Shower Trim Kit With Showerhead, Double Ceramic Pressure Balance Cartridge With Lever Handle

- Includes Double Ceramic pressure balance cartridge
- 7" (178 mm) showerhead, 2.5 gpm/9.5 L/min maximum flow
- Shower arm and flange
- Brass wall escutcheon
- Metal lever handle
- Metal slip-on diverter tub spout
- For use with Flash® shower rough-in valves

TU186502.002	Polished Chrome	268
TU186502.278	Legacy Bronze	386
TU186502.295	Brushed Nickel	361



Fluent® 2.5 gpm/9.5 L/min Shower Trim Kit With Double Ceramic Pressure Balance Cartridge With Lever Handle



- Includes Double Ceramic pressure balance cartridge
- 7" (178 mm) showerhead, 2.5 gpm/9.5 L/min maximum flow
- Shower arm and flange
- Brass wall escutcheon
- Metal lever handle
- For use with Flash® shower rough-in valves

TU186501.002	Polished Chrome	241
TU186501.295	Brushed Nickel	325









Fluent® Valve Only Trim Kit With Double Ceramic Pressure Balance Cartridge With Lever Handle







- Includes Double Ceramic pressure balance cartridge
- Brass wall escutcheon
- Metal lever handle
- For use with Flash® rough-in valves

TU186500.002	Polished Chrome	212
TU186500.295	Brushed Nickel	284



	Description	SKU #	Color/Finish	List Price
   	<p>Fluent® 1.8 gpm/6.8 L/min Tub and Shower Trim Kit With Water-Saving Showerhead, Double Ceramic Pressure Balance Cartridge With Lever Handle</p> <p>CEC</p> <ul style="list-style-type: none"> • Includes Double Ceramic pressure balance cartridge • Water-saving 7" (178 mm) showerhead, 1.8 gpm/6.8 L/min maximum flow • Shower arm and flange • Brass wall escutcheon • Metal lever handle • Metal slip-on diverter tub spout • For use with Flash® shower rough-in valves 	TU186508.002	Polished Chrome	268
		TU186508.295	Brushed Nickel	361
  	<p>Fluent® 1.8 gpm/6.8 L/min Shower Trim Kit With Water-Saving Showerhead, Double Ceramic Pressure Balance Cartridge With Lever Handle</p> <p>ADA CEC</p> <ul style="list-style-type: none"> • Includes Double Ceramic pressure balance cartridge • Water-saving 7" (178 mm) showerhead, 1.8 gpm/6.8 L/min maximum flow • Shower arm and flange • Brass wall escutcheon • Metal lever handle • For use with Flash® shower rough-in valves 	TU186507.002	Polished Chrome	241
		TU186507.295	Brushed Nickel	325











	Description	SKU #	Color/Finish	List Price
	<p>Flash® Shower Rough-In Valve With Universal Inlets/Outlets</p> <ul style="list-style-type: none"> • ½" (13 mm) male NPT/Sweat inlets/outlets accept ½" copper, ½" iron pipe, PEX or CPVC adapters • Cast DZR brass valve body • Flow rate: 5.1 gpm @ 45 psi* • Back-to-back capability • Includes flush plug with stainless steel ring • Cartridge ships with trim • For use with TU series pressure balance bath/shower trim kits 	RU101	No Finish	72
	<p>Flash® Shower Rough-In Valve With Universal Inlets/Outlets With Screwdriver Stops</p> <ul style="list-style-type: none"> • ½" (13 mm) male NPT/Sweat inlets/outlets accept ½" copper, ½" iron pipe, PEX or CPVC adapters • Cast DZR brass valve body • Flow rate: 5.1 gpm @ 45 psi* • Back-to-back capability • Includes flush plug with stainless steel ring • Includes screwdriver stops for easy servicing at the valve • For use with TU series pressure balance bath/shower trim kits 	RU101SS	No Finish	103
	<p>Flash® Shower Rough-In Valve With Stub-Outs</p> <ul style="list-style-type: none"> • ½" (13 mm) Stub-out inlets/outlets accept ½" press-connect fittings • Cast DZR brass valve body • Flow rate: 5.1 gpm @ 45 psi* • Back-to-back capability • Includes flush plug with stainless steel ring • Cartridge ships with trim • For use with TU series pressure balance bath/shower trim kits 	RU102	No Finish	72
	<p>Flash® Shower Rough-In Valve With Stub-Outs With Screwdriver Stops</p> <ul style="list-style-type: none"> • ½" (13 mm) Stub-out inlets/outlets accept ½" press-connect fittings • Cast DZR brass valve body • Flow rate: 5.1 gpm @ 45 psi* • Back-to-back capability • Includes flush plug with stainless steel ring • Includes screwdriver stops for easy servicing at the valve • Cartridge ships with trim • For use with TU series pressure balance bath/shower trim kits 	RU102SS	No Finish	103
	<p>Flash® Shower Rough-In Valve With PEX Inlets/Universal Outlets for Crimp Ring System</p> <ul style="list-style-type: none"> • ½" (3 mm) PEX crimp inlets/Universal outlets (ASTM F1807) • Cast DZR brass valve body • Flow rate: 5.1 gpm @ 45 psi* • Back-to-back capability • Includes flush plug with stainless steel ring • Cartridge ships with trim • For use with TU series pressure balance bath/shower trim kits 	RU107	No Finish	72









*When combined with Double Ceramic pressure balance cartridge.





	Description	SKU #	Color/Finish	List Price
	<p>Flash® Shower Rough-In Valve With PEX Inlets/Universal Outlets With Screwdriver Stops for Crimp Ring System</p> <ul style="list-style-type: none"> • ½" (13 mm) PEX crimp inlets/Universal outlets (ASTM F1807) • Cast DZR brass valve body • Flow rate: 5.1 gpm @ 45 psi* • Back-to-back capability • Includes flush plug with stainless steel ring • Includes screwdriver stops for easy servicing at the valve • Cartridge ships with trim • For use with TU series pressure balance bath/shower trim kits 	RU107SS	No Finish	103
	<p>Flash® Shower Rough-In Valve With PEX Inlet Elbows/Universal Outlets for Crimp Ring System</p> <ul style="list-style-type: none"> • ½" (13 mm) PEX crimp elbow inlets/Universal outlets (ASTM F1807) • Cast DZR brass valve body • Flow rate: 5.1 gpm @ 45 psi* • Back-to-back capability • Includes flush plug with stainless steel ring • Cartridge ships with trim • For use with TU series pressure balance bath/shower trim kits 	RU107E	No Finish	95
	<p>Flash® Shower Rough-In Valve With PEX Inlet Elbows/Universal Outlets With Screwdriver Stops for Crimp Ring System</p> <ul style="list-style-type: none"> • ½" (13 mm) PEX crimp elbow inlets/Universal outlets (ASTM F1807) • Cast DZR brass valve body • Flow rate: 5.1 gpm @ 45 psi* • Back-to-back capability • Includes flush plug with stainless steel ring • Includes screwdriver stops for easy servicing at the valve • Cartridge ships with trim • For use with TU series pressure balance bath/shower trim kits 	RU107ESS	No Finish	125
	<p>Flash® Shower Rough-In Valve With PEX Inlets/Universal Outlets for Cold Expansion System</p> <ul style="list-style-type: none"> • ½" (13 mm) PEX cold expansion inlets/Universal outlets (ASTM F1960) • Cast DZR brass valve body • Flow rate: 5.1 gpm @ 45 psi* • Back-to-back capability • Includes flush plug with stainless steel ring • Cartridge ships with trim • For use with TU series pressure balance bath/shower trim kits 	RU108	No Finish	72
	<p>Flash® Shower Rough-In Valve With PEX Inlets/Universal Outlets With Screwdriver Stops for Cold Expansion System</p> <ul style="list-style-type: none"> • ½" (13 mm) PEX cold expansion inlets/Universal outlets (ASTM F1960) • Cast DZR brass valve body • Flow rate: 5.1 gpm @ 45 psi* • Back-to-back capability • Includes flush plug with stainless steel ring • Includes screwdriver stops for easy servicing at the valve • For use with TU series pressure balance bath/shower trim kits 	RU108SS	No Finish	103

*When combined with Double Ceramic pressure balance cartridge.

	Description	SKU #	Color/Finish	List Price
	<p>Flash® Shower Rough-In Valve With PEX Inlet Elbows/Universal Outlets for Cold Expansion System</p> <ul style="list-style-type: none"> • ½" (13 mm) PEX cold expansion elbow inlets/ Universal outlets (ASTM F1960) • Cast DZR brass valve body • Flow rate: 5.1 gpm @ 45 psi* • Back-to-back capability • Includes flush plug with stainless steel ring • Cartridge ships with trim • For use with TU series pressure balance bath/ shower trim kits 	RU108E	No Finish	95 
	<p>Flash® Shower Rough-In Valve With PRX Inlet Elbows/Universal Outlets With Screwdriver Stops for Cold Expansion System</p> <ul style="list-style-type: none"> • ½" (13 mm) PEX cold expansion elbow inlets/ Universal outlets (ASTM F1960) • Cast DZR brass valve body • Flow rate: 5.1 gpm @ 45 psi* • Back-to-back capability • Includes flush plug with stainless steel ring • Includes screwdriver stops for easy servicing at the valve • Cartridge ships with trim • For use with TU series pressure balance bath/ shower trim kits 	RU108ESS	No Finish	125 
	<p>Flash® Shower Rough-In Valve With CPVC Inlets/Universal Outlets</p> <ul style="list-style-type: none"> • ½" (13 mm) CPVC inlets/Universal outlets • Cast DZR brass valve body • Flow rate: 5.1 gpm @ 45 psi* • Back-to-back capability • Includes flush plug with stainless steel ring • Cartridge ships with trim • For use with TU series pressure balance bath/ shower trim kits 	RU109	No Finish	95 
	<p>Flash® Shower Rough-In Valve With CPVC Inlets/Universal Outlets With Screwdriver Stops</p> <ul style="list-style-type: none"> • ½" (13 mm) CPVC inlets/Universal outlets • Cast DZR brass valve body • Flow rate: 5.1 gpm @ 45 psi* • Back-to-back capability • Includes flush plug with stainless steel ring • Includes screwdriver stops for easy servicing at the valve • Cartridge ships with trim • For use with TU series pressure balance bath/ shower trim kits 	RU109SS	No Finish	125 

*When combined with Double Ceramic pressure balance cartridge.

	Description	SKU #	Color/Finish	List Price
	Fluent® Single-Handle Diverter Valve Trim Kit	T186430.002	Polished Chrome	111
	<ul style="list-style-type: none"> • Metal lever handle • Less valve (must be purchased separately) • Trim kit for valve bodies R422, R422S, R423 and R423S 	T186430.295	Brushed Nickel	155
	2-Way In-Wall Diverter Rough-In Valve With 2 Discrete Functions	R422	No Finish	231
	<ul style="list-style-type: none"> • Durable cast brass valve body – excellent for high use applications with prolonged water use • Controls water flow between 2 outlets (shower or sprays) • ½" (13 mm) NPT inlets/outlets • Trim must be ordered separately 			
	2-Way In-Wall Diverter Rough-In Valve With 2 Discrete/1 Shared Function	R422S	No Finish	231
	<ul style="list-style-type: none"> • Durable cast brass valve body – excellent for high use applications with prolonged water use • Controls water flow between 2 outlets (shower or sprays) • ½" (13 mm) NPT inlets/outlets • Trim must be ordered separately 			
	3-Way In-Wall Diverter Rough-In Valve With 3 Discrete Functions	R433	No Finish	262
	<ul style="list-style-type: none"> • Durable cast brass valve body – excellent for high use applications with prolonged water use • Controls water flow between 3 outlets (shower or sprays) • ½" (13 mm) NPT inlets/outlets • Trim must be ordered separately 			
	3-Way In-Wall Diverter Rough-In Valve With 3 Discrete/3 Shared Functions	R433S	No Finish	262
	<ul style="list-style-type: none"> • Durable cast brass valve body – excellent for high use applications with prolonged water use • Controls water flow between 3 outlets (shower or sprays) • ½" (13 mm) NPT inlets/outlets • Trim must be ordered separately 			

	Description	SKU #	Color/Finish	List Price
	C Series 18-Inch Towel Bar <ul style="list-style-type: none"> • Brass bar • All metal construction • Concealed mounting: no exposed set screws • Easy to install • Limited lifetime warranty on function and finish 	8337018.002	Polished Chrome	66
		8337018.013	Polished Nickel	92
		8337018.278	Legacy Bronze	100
		8337018.295	Brushed Nickel	92
	C Series 24-Inch Towel Bar <ul style="list-style-type: none"> • Brass bar • All metal construction • Concealed mounting: no exposed set screws • Easy to install • Limited lifetime warranty on function and finish 	8337024.002	Polished Chrome	70
		8337024.013	Polished Nickel	98
		8337024.278	Legacy Bronze	104
		8337024.295	Brushed Nickel	98
	C Series Towel Ring <ul style="list-style-type: none"> • Concealed mounting with no exposed screws for a seamless appearance • Bushing on towel ring to prevent scratching and squeaking • Easy to install • 7" (178 mm) diameter ring • Limited lifetime warranty on function and finish 	8337190.002	Polished Chrome	41
		8337190.013	Polished Nickel	57
		8337190.278	Legacy Bronze	61
		8337190.295	Brushed Nickel	57
	C Series Double Robe Hook <ul style="list-style-type: none"> • All metal construction • Concealed mounting: no exposed set screws • Easy to install • Limited lifetime warranty on function and finish • Solid metal construction is durable and long-lasting 	8337210.002	Polished Chrome	31
		8337210.013	Polished Nickel	43
		8337210.278	Legacy Bronze	43
		8337210.295	Brushed Nickel	43
	C Series Toilet Paper Holder <ul style="list-style-type: none"> • All metal construction • Concealed mounting: no exposed set screws • Easy to install • Limited lifetime warranty on function and finish 	8337230.002	Polished Chrome	53
		8337230.013	Polished Nickel	76
		8337230.278	Legacy Bronze	82
		8337230.295	Brushed Nickel	76



Fluent

Enhanced by classic details, the traditional style of the **Glenmere Collection** will stand the test of time. Designed for durability, reliable performance, and lasting beauty in the busiest bathroom.



Sink



Widespread Faucet
7617807



Centerset Faucet
7617207



Monoblock Faucet
7617107

Shower



Bath/Shower Trim Kits

Accessories



24" Towel Bar
7617024









Towel Ring
7617190







Toilet Paper Holder
7617230



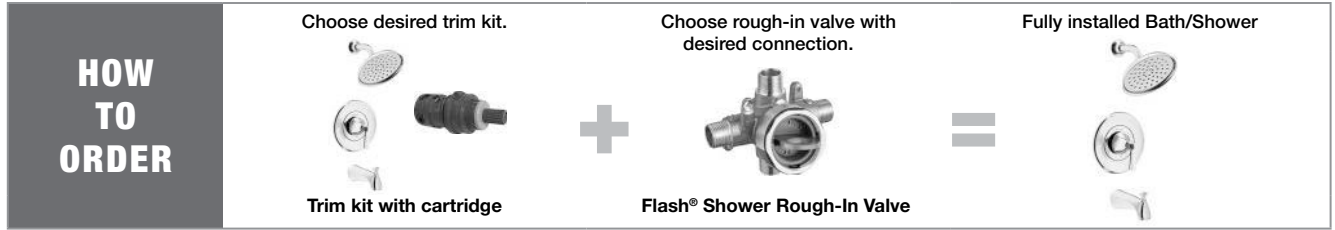









Double Robe Hook
7617210

	Description	SKU #	Color/Finish	List Price
 	Glenmere™ 8-Inch Widespread 2-Handle Bathroom Faucet 1.2 gpm/4.5 L/min With Lever Handles <ul style="list-style-type: none"> • Metal construction • Washerless ceramic disc valve cartridges • Water-conserving 1.2 gpm/4.5 L/min pressure-compensating aerator • Metal spout • Brass hybrid valves with reinforced flexible hose connections for 6" - 12" (152 - 305 mm) installations • Braided flexible supply hoses with 3/8" (10 mm) compression connectors • Metal lever handles • Metal push pop up drain 	CEC 7617807.002	Polished Chrome	349
		7617807.243	Matte Black	454
		7617807.278	Legacy Bronze	419
		7617807.295	Brushed Nickel	419
 	Glenmere™ 4-Inch Centerset 2-Handle Bathroom Faucet 1.2 gpm/4.5 L/min With Lever Handles <ul style="list-style-type: none"> • Metal construction • Washerless ceramic disc valve cartridges • Water-conserving 1.2 gpm/4.5 L/min pressure-compensating aerator • Metal spout • Metal lever handles • Metal push pop up drain 	CEC 7617207.002	Polished Chrome	155
		7617207.243	Matte Black	202
		7617207.278	Legacy Bronze	186
		7617207.295	Brushed Nickel	186
 	Glenmere™ Single Hole Single-Handle Bathroom Faucet 1.2 gpm/4.5 L/min With Lever Handle <ul style="list-style-type: none"> • Metal construction • Washerless ceramic disc valve cartridges • Water-conserving 1.2 gpm/4.5 L/min pressure-compensating aerator • Metal spout • Braided flexible supply hoses with 3/8" (10 mm) compression connectors • Metal lever handle • Includes optional deck plate • Metal push pop up drain 	CEC 7617107.002	Polished Chrome	243
		7617107.243	Matte Black	316
		7617107.278	Legacy Bronze	292
		7617107.295	Brushed Nickel	292











	Description	SKU #	Color/Finish	List Price
   	Glenmere™ 1.8 gpm/6.8 L/min Tub and Shower Trim Kit With Water-Saving Showerhead, Double Ceramic Pressure Balance Cartridge With Lever Handle	TU617508.002	Polished Chrome	170
		TU617508.243	Matte Black	221
		TU617508.278	Legacy Bronze	204
		TU617508.295	Brushed Nickel	204
	<ul style="list-style-type: none"> • Includes Double Ceramic pressure balance cartridge • Water-saving showerhead, 1.8 gpm/6.8 L/min maximum flow • Shower arm and flange • Metal wall escutcheon • Metal lever handle • IPS diverter tub spout • For use with Flash® shower rough-in valves 			

	Description	SKU #	Color/Finish	List Price
	<p>Flash® Shower Rough-In Valve With Universal Inlets/Outlets</p> <ul style="list-style-type: none"> • ½" (13 mm) male NPT/Sweat inlets/outlets accept ½" copper, ½" iron pipe, PEX or CPVC adapters • Cast DZR brass valve body • Flow rate: 5.1 gpm @ 45 psi* • Back-to-back capability • Includes flush plug with stainless steel ring • Cartridge ships with trim • For use with TU series pressure balance bath/shower trim kits 	RU101	No Finish	72 
	<p>Flash® Shower Rough-In Valve With Universal Inlets/Outlets With Screwdriver Stops</p> <ul style="list-style-type: none"> • ½" (13 mm) male NPT/Sweat inlets/outlets accept ½" copper, ½" iron pipe, PEX or CPVC adapters • Cast DZR brass valve body • Flow rate: 5.1 gpm @ 45 psi* • Back-to-back capability • Includes flush plug with stainless steel ring • Includes screwdriver stops for easy servicing at the valve • For use with TU series pressure balance bath/shower trim kits 	RU101SS	No Finish	103 
	<p>Flash® Shower Rough-In Valve With Stub-Outs</p> <ul style="list-style-type: none"> • ½" (13 mm) Stub-out inlets/outlets accept ½" press-connect fittings • Cast DZR brass valve body • Flow rate: 5.1 gpm @ 45 psi* • Back-to-back capability • Includes flush plug with stainless steel ring • Cartridge ships with trim • For use with TU series pressure balance bath/shower trim kits 	RU102	No Finish	72 
	<p>Flash® Shower Rough-In Valve With Stub-Outs With Screwdriver Stops</p> <ul style="list-style-type: none"> • ½" (13 mm) Stub-out inlets/outlets accept ½" press-connect fittings • Cast DZR brass valve body • Flow rate: 5.1 gpm @ 45 psi* • Back-to-back capability • Includes flush plug with stainless steel ring • Includes screwdriver stops for easy servicing at the valve • Cartridge ships with trim • For use with TU series pressure balance bath/shower trim kits 	RU102SS	No Finish	103 
	<p>Flash® Shower Rough-In Valve With PEX Inlets/Universal Outlets for Crimp Ring System</p> <ul style="list-style-type: none"> • ½" (3 mm) PEX crimp inlets/Universal outlets (ASTM F1807) • Cast DZR brass valve body • Flow rate: 5.1 gpm @ 45 psi* • Back-to-back capability • Includes flush plug with stainless steel ring • Cartridge ships with trim • For use with TU series pressure balance bath/shower trim kits 	RU107	No Finish	72 





*When combined with Double Ceramic pressure balance cartridge.

	Description	SKU #	Color/Finish	List Price
	<p>Flash® Shower Rough-In Valve With PEX Inlets/Universal Outlets With Screwdriver Stops for Crimp Ring System</p> <ul style="list-style-type: none"> • ½" (13 mm) PEX crimp inlets/Universal outlets (ASTM F1807) • Cast DZR brass valve body • Flow rate: 5.1 gpm @ 45 psi* • Back-to-back capability • Includes flush plug with stainless steel ring • Includes screwdriver stops for easy servicing at the valve • Cartridge ships with trim • For use with TU series pressure balance bath/shower trim kits 	RU107SS	No Finish	103 
	<p>Flash® Shower Rough-In Valve With PEX Inlet Elbows/Universal Outlets for Crimp Ring System</p> <ul style="list-style-type: none"> • ½" (13 mm) PEX crimp elbow inlets/Universal outlets (ASTM F1807) • Cast DZR brass valve body • Flow rate: 5.1 gpm @ 45 psi* • Back-to-back capability • Includes flush plug with stainless steel ring • Cartridge ships with trim • For use with TU series pressure balance bath/shower trim kits 	RU107E	No Finish	95 
	<p>Flash® Shower Rough-In Valve With PEX Inlet Elbows/Universal Outlets With Screwdriver Stops for Crimp Ring System</p> <ul style="list-style-type: none"> • ½" (13 mm) PEX crimp elbow inlets/Universal outlets (ASTM F1807) • Cast DZR brass valve body • Flow rate: 5.1 gpm @ 45 psi* • Back-to-back capability • Includes flush plug with stainless steel ring • Includes screwdriver stops for easy servicing at the valve • Cartridge ships with trim • For use with TU series pressure balance bath/shower trim kits 	RU107ESS	No Finish	125 
	<p>Flash® Shower Rough-In Valve With PEX Inlets/Universal Outlets for Cold Expansion System</p> <ul style="list-style-type: none"> • ½" (13 mm) PEX cold expansion inlets/Universal outlets (ASTM F1960) • Cast DZR brass valve body • Flow rate: 5.1 gpm @ 45 psi* • Back-to-back capability • Includes flush plug with stainless steel ring • Cartridge ships with trim • For use with TU series pressure balance bath/shower trim kits 	RU108	No Finish	72 
	<p>Flash® Shower Rough-In Valve With PEX Inlets/Universal Outlets With Screwdriver Stops for Cold Expansion System</p> <ul style="list-style-type: none"> • ½" (13 mm) PEX cold expansion inlets/Universal outlets (ASTM F1960) • Cast DZR brass valve body • Flow rate: 5.1 gpm @ 45 psi* • Back-to-back capability • Includes flush plug with stainless steel ring • Includes screwdriver stops for easy servicing at the valve • For use with TU series pressure balance bath/shower trim kits 	RU108SS	No Finish	103 

*When combined with Double Ceramic pressure balance cartridge.

	Description	SKU #	Color/Finish	List Price
	<p>Flash® Shower Rough-In Valve With PEX Inlet Elbows/Universal Outlets for Cold Expansion System</p> <ul style="list-style-type: none"> • ½" (13 mm) PEX cold expansion elbow inlets/ Universal outlets (ASTM F1960) • Cast DZR brass valve body • Flow rate: 5.1 gpm @ 45 psi* • Back-to-back capability • Includes flush plug with stainless steel ring • Cartridge ships with trim • For use with TU series pressure balance bath/ shower trim kits 	RU108E	No Finish	95 
	<p>Flash® Shower Rough-In Valve With PRX Inlet Elbows/Universal Outlets With Screwdriver Stops for Cold Expansion System</p> <ul style="list-style-type: none"> • ½" (13 mm) PEX cold expansion elbow inlets/ Universal outlets (ASTM F1960) • Cast DZR brass valve body • Flow rate: 5.1 gpm @ 45 psi* • Back-to-back capability • Includes flush plug with stainless steel ring • Includes screwdriver stops for easy servicing at the valve • Cartridge ships with trim • For use with TU series pressure balance bath/ shower trim kits 	RU108ESS	No Finish	125 
	<p>Flash® Shower Rough-In Valve With CPVC Inlets/Universal Outlets</p> <ul style="list-style-type: none"> • ½" (13 mm) CPVC inlets/Universal outlets • Cast DZR brass valve body • Flow rate: 5.1 gpm @ 45 psi* • Back-to-back capability • Includes flush plug with stainless steel ring • Cartridge ships with trim • For use with TU series pressure balance bath/ shower trim kits 	RU109	No Finish	95 
	<p>Flash® Shower Rough-In Valve With CPVC Inlets/Universal Outlets With Screwdriver Stops</p> <ul style="list-style-type: none"> • ½" (13 mm) CPVC inlets/Universal outlets • Cast DZR brass valve body • Flow rate: 5.1 gpm @ 45 psi* • Back-to-back capability • Includes flush plug with stainless steel ring • Includes screwdriver stops for easy servicing at the valve • Cartridge ships with trim • For use with TU series pressure balance bath/ shower trim kits 	RU109SS	No Finish	125 

*When combined with Double Ceramic pressure balance cartridge.

	Description	SKU #	Color/Finish	List Price
	Glenmere™ 24-inch Towel Bar • All metal construction • Concealed mounting	7617024.002	Polished Chrome	57
		7617024.243	Matte Black	84
		7617024.278	Legacy Bronze	75
		7617024.295	Brushed Nickel	65
		<hr/>		
	Glenmere™ Towel Ring • 7" (178 mm) diameter ring • All metal construction • Concealed mounting	7617190.002	Polished Chrome	41
		7617190.243	Matte Black	60
		7617190.278	Legacy Bronze	54
		7617190.295	Brushed Nickel	47
		<hr/>		
	Glenmere™ Robe Hook • All metal construction • Concealed mounting	7617210.002	Polished Chrome	31
		7617210.243	Matte Black	46
		7617210.278	Legacy Bronze	42
		7617210.295	Brushed Nickel	36
		<hr/>		
	Glenmere™ Toilet Paper Holder • All metal construction • Concealed mounting	7617230.002	Polished Chrome	50
		7617230.243	Matte Black	74
		7617230.278	Legacy Bronze	68
		7617230.295	Brushed Nickel	46

Practical by design, the **Reliant 3 Collection** boasts ergonomic features for enhanced functionality without sacrificing style, and superior engineering for dependable use.



Sink



Centerset Faucets

Shower



Bath/Shower Trim Kit
TU385502



Bath/Shower Trim Kit
TU385508



Valve Only Trim Kit
With Decal
TU385500WD

Accessories



C Series 18" Towel Bar
8337018



C Series 24" Towel Bar
8337024



















C Series Towel Ring
8337190

























C Series
Toilet Paper Holder
8337230



C Series
Double Robe Hook
8337210



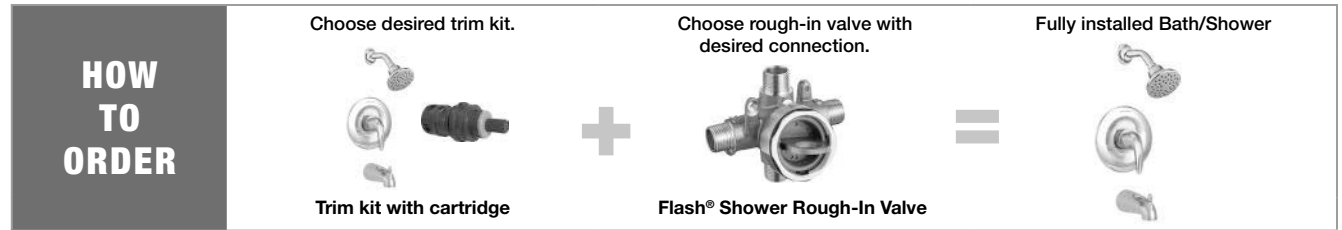

	Description	SKU #	Color/Finish	List Price
 	<p>Reliant 3® 4-Inch Centerset Single-Handle Bathroom Faucet 1.2 gpm/4.5 L/min With Lever Handle</p> <ul style="list-style-type: none"> • Water-conserving 1.2 gpm/4.5 L/min pressure-compensating aerator • 47 mm ceramic disc valve cartridge with an adjustable Hot Limit Safety Stop • Cast brass waterway with flexible supply hoses • Braided flexible supply hoses with 3/8" (10 mm) compression connectors • Red/Blue index button included • Metal lever handle • Metal Speed Connect® pop-up drain 	 	<p>7385000.002 Polished Chrome</p> <p>7385000.295 Brushed Nickel</p>	<p>196</p> <p>275</p>
	<p>Reliant 3® 4-Inch Centerset Single-Handle Bathroom Faucet 1.2 gpm/4.5 L/min With Lever Handles</p> <ul style="list-style-type: none"> • Water-conserving 1.2 gpm/4.5 L/min pressure-compensating aerator • 47 mm ceramic disc valve cartridge with an adjustable Hot Limit Safety Stop • Extra long braided flexible supply hoses with 3/8" (10 mm) compression connectors • Red/Blue index button included • Metal lever handle • Metal Speed Connect® pop-up drain 		<p>7385LS000.002 Polished Chrome</p>	<p>196</p>
 	<p>Reliant 3® 4-Inch Centerset Single-Handle Bathroom Faucet 1.2 gpm/4.5 L/min With Lever Handle</p> <ul style="list-style-type: none"> • Water-conserving 1.2 gpm/4.5 L/min pressure-compensating aerator • 47 mm ceramic disc valve cartridge with an adjustable Hot Limit Safety Stop • Braided flexible supply hoses with 3/8" (10 mm) compression connectors • Red/Blue index button included • Indexed Red/Blue metal lever handle • Metal Speed Connect® pop-up drain 	 	<p>7385008.002 Polished Chrome</p>	<p>201</p>
 	<p>Reliant 3® 4-Inch Centerset Single-Handle Bathroom Faucet 1.2 gpm/4.5 L/min With Lever Handle</p> <ul style="list-style-type: none"> • Water-conserving 1.2 gpm/4.5 L/min pressure-compensating aerator • 47 mm ceramic disc valve cartridge with an adjustable Hot Limit Safety Stop • Cast brass waterway with flexible supply hoses • Braided flexible supply hoses with 3/8" (10 mm) compression connectors • Red/Blue index button included • Indexed Red/Blue metal lever handle • Grid drain • Less pop-up hole 	 	<p>7385003.002 Polished Chrome</p>	<p>196</p>
 	<p>Reliant 3® 4-Inch Centerset Single-Handle Bathroom Faucet 0.5 gpm/1.9 L/min With Lever Handle</p> <ul style="list-style-type: none"> • Water-conserving 0.5 gpm/1.9 L/min pressure-compensating aerator • 47 mm ceramic disc valve cartridge with an adjustable Hot Limit Safety Stop • Cast brass waterway • Braided flexible supply hoses with 3/8" (10 mm) compression connectors • Red/Blue index button included • Indexed Red/Blue metal lever handle • Metal Speed Connect® pop-up drain 		<p>7385LHV05003.002 Polished Chrome</p>	<p>196</p>

	Description	SKU #	Color/Finish	List Price
 	<p>Reliant 3® 4-Inch Centerset Single-Handle Bathroom Faucet 1.2 gpm/4.5 L/min With Lever Handle</p> <ul style="list-style-type: none"> • Water-conserving 1.2 gpm/4.5 L/min pressure-compensating aerator • 47 mm ceramic disc valve cartridge with an adjustable Hot Limit Safety Stop • Cast brass waterway with flexible supply hoses • Braided flexible supply hoses with 3/8" (10 mm) compression connectors • Red/Blue index button included • Indexed Red/Blue metal lever handle • Less drain • Less pop-up rod • With pop-up hole 	 	<p>7385007.002 Polished Chrome</p>	<p>177</p>
 	<p>Reliant 3® 4-Inch Centerset Single-Handle Bathroom Faucet 1.2 gpm/4.5 L/min With Lever Handle</p> <ul style="list-style-type: none"> • Water-conserving 1.2 gpm/4.5 L/min pressure-compensating aerator • 47 mm ceramic disc valve cartridge with an adjustable Hot Limit Safety Stop • Cast brass waterway with flexible supply hoses • Braided flexible supply hoses with 3/8" (10 mm) compression connectors • Red/Blue index button included • Indexed Red/Blue metal lever handle • Less drain • Less pop-up rod • Less pop-up hole 	 	<p>7385004.002 Polished Chrome 7385004.295 Brushed Nickel</p>	<p>177 247</p>
	<p>Reliant 3® 4-Inch Centerset Single-Handle Bathroom Faucet 0.5 gpm/1.9 L/min With Lever Handle</p> <ul style="list-style-type: none"> • Water-conserving 0.5 gpm/1.9 L/min pressure-compensating aerator spray • 47 mm ceramic disc valve cartridge with adjustable Hot Limit Safety Stop • All metal construction • Vandal-resistant non aerator spray • Cast brass waterway • Braided flexible supply hoses with 3/8" (10 mm) compression connectors • Red/Blue index button included • Indexed Red/Blue metal lever handle • Metal Speed Connect® pop-up drain 	 	<p>7385058.002 Polished Chrome</p>	<p>199</p>
	<p>Reliant 3® 4-Inch Centerset Single-Handle Bathroom Faucet 0.5 gpm/1.9 L/min With Lever Handle</p> <ul style="list-style-type: none"> • Water-conserving 0.5 gpm/1.9 L/min pressure-compensating aerator spray • 47 mm ceramic disc valve cartridge with adjustable Hot Limit Safety Stop • All metal construction • Vandal-resistant non aerator spray • Cast brass waterway • Braided flexible supply hoses with 3/8" (10 mm) compression connectors • Red/Blue index button included • Indexed Red/Blue metal lever handle • Grid drain • Less pop-up hole 	 	<p>7385053.002 Polished Chrome</p>	<p>199</p>

	Description	SKU #	Color/Finish	List Price
	<p>Reliant 3® 4-Inch Centerset Single-Handle Bathroom Faucet 0.5 gpm/1.9 L/min With Lever Handle</p> <p> </p> <ul style="list-style-type: none"> • Water-conserving 0.5 gpm/1.9 L/min pressure-compensating aerator spray • 47 mm ceramic disc valve cartridge with an adjustable Hot Limit Safety Stop • Cast brass waterway with flexible supply hoses • Vandal-resistant non-aerator spray • Braided flexible supply hoses with 3/8" (10 mm) compression connectors • Indexed Red/Blue metal lever handle • Less drain • Less pop-up hole 	7385050.002	Polished Chrome	180
	<p>Reliant 3® 4-Inch Centerset Single-Handle Bathroom Faucet 1.2 gpm/4.5 L/min With Lever Handle</p> <p> </p> <ul style="list-style-type: none"> • Water-conserving 1.2 gpm/4.5 L/min pressure-compensating aerator • 47 mm ceramic disc valve cartridge with adjustable Hot Limit Safety Stop • All metal construction • Cast brass waterway • 3/8" (10 mm) copper supplies with 1/2" (13 mm) male adapters • Metal lever handle • Red/Blue index button included • Metal Speed Connect® pop-up drain 	7385045.295	Brushed Nickel	331
	<p>Reliant 3® 4-Inch Centerset Single-Handle Bathroom Faucet 1.2 gpm/4.5 L/min With Lever Handle</p> <p> </p> <ul style="list-style-type: none"> • Water-conserving 1.2 gpm/4.5 L/min pressure-compensating aerator spray • 47 mm ceramic disc valve cartridge with adjustable Hot Limit Safety Stop • All metal construction • Cast brass waterway • 3/8" (10 mm) copper supplies with 1/2" (13 mm) male adapters • Metal lever handle • Red/Blue index button included • Less Drain • Less pop-up hole 	7385047.002	Polished Chrome	214







	Description	SKU #	Color/Finish	List Price
	<p>Reliant 3® 2.5 gpm/9.5 L/min Tub and Shower Trim Kit With Showerhead, Double Ceramic Pressure Balance Cartridge With Lever Handle</p> <ul style="list-style-type: none"> • Includes Double Ceramic pressure balance cartridge • "Easy Clean" 4-1/2" (115 mm) showerhead, 2.5 gpm/9.5 L/min maximum flow • Shower arm and flange • Metal wall escutcheon • Slip-on diverter tub spout • For use with Flash® shower rough-in valves 	TU385502.002	Polished Chrome	195
		TU385502.295	Brushed Nickel	262
	<p>Reliant 3® 2.5 gpm/9.5 L/min Shower Trim Kit With Showerhead, Double Ceramic Pressure Balance Cartridge With Lever Handle</p> <ul style="list-style-type: none"> • Includes Double Ceramic pressure balance cartridge • "Easy Clean" 4-1/2" (115 mm) showerhead, 2.5 gpm/9.5 L/min maximum flow • Shower arm and flange • Metal wall escutcheon • Metal lever handle • For use with Flash® shower rough-in valves 	 TU385501.002	Polished Chrome	156
		TU385501.295	Brushed Nickel	205
	<p>Reliant 3® Valve Only Trim Kit With Double Ceramic Pressure Balance Cartridge With Lever Handle</p> <ul style="list-style-type: none"> • Includes Double Ceramic pressure balance cartridge • Metal wall escutcheon • Metal lever handle • For use with Flash® shower rough-in valves 	 TU385500.002	Polished Chrome	109
		TU385500.295	Brushed Nickel	142
 	<p>Reliant 3® 1.75 gpm/6.6 L/min Tub and Shower Trim Kit With Double Ceramic Pressure Balance Cartridge With Lever Handle</p> <ul style="list-style-type: none"> • Includes Double Ceramic pressure balance cartridge • Water-saving 3-3/4" (96 mm) 1.75 gpm/6.6 L/min maximum flow • Shower arm and flange • Metal wall escutcheon • Metal lever handle • Slip-on diverter tub spout • For use with Flash® shower rough-in valves 	 TU385508.002	Polished Chrome	195

	Description	SKU #	Color/Finish	List Price
	<p>Flash® Shower Rough-In Valve With Universal Inlets/Outlets</p> <ul style="list-style-type: none"> • ½" (13 mm) male NPT/Sweat inlets/outlets accept ½" copper, ½" iron pipe, PEX or CPVC adapters • Cast DZR brass valve body • Flow rate: 5.1 gpm @ 45 psi* • Back-to-back capability • Includes flush plug with stainless steel ring • Cartridge ships with trim • For use with TU series pressure balance bath/shower trim kits 	RU101	No Finish	72
	<p>Flash® Shower Rough-In Valve With Universal Inlets/Outlets With Screwdriver Stops</p> <ul style="list-style-type: none"> • ½" (13 mm) male NPT/Sweat inlets/outlets accept ½" copper, ½" iron pipe, PEX or CPVC adapters • Cast DZR brass valve body • Flow rate: 5.1 gpm @ 45 psi* • Back-to-back capability • Includes flush plug with stainless steel ring • Includes screwdriver stops for easy servicing at the valve • For use with TU series pressure balance bath/shower trim kits 	RU101SS	No Finish	103
	<p>Flash® Shower Rough-In Valve With Stub-Outs</p> <ul style="list-style-type: none"> • ½" (13 mm) Stub-out inlets/outlets accept ½" press-connect fittings • Cast DZR brass valve body • Flow rate: 5.1 gpm @ 45 psi* • Back-to-back capability • Includes flush plug with stainless steel ring • Cartridge ships with trim • For use with TU series pressure balance bath/shower trim kits 	RU102	No Finish	72
	<p>Flash® Shower Rough-In Valve With Stub-Outs With Screwdriver Stops</p> <ul style="list-style-type: none"> • ½" (13 mm) Stub-out inlets/outlets accept ½" press-connect fittings • Cast DZR brass valve body • Flow rate: 5.1 gpm @ 45 psi* • Back-to-back capability • Includes flush plug with stainless steel ring • Includes screwdriver stops for easy servicing at the valve • Cartridge ships with trim • For use with TU series pressure balance bath/shower trim kits 	RU102SS	No Finish	103
	<p>Flash® Shower Rough-In Valve With PEX Inlets/Universal Outlets for Crimp Ring System</p> <ul style="list-style-type: none"> • ½" (3 mm) PEX crimp inlets/Universal outlets (ASTM F1807) • Cast DZR brass valve body • Flow rate: 5.1 gpm @ 45 psi* • Back-to-back capability • Includes flush plug with stainless steel ring • Cartridge ships with trim • For use with TU series pressure balance bath/shower trim kits 	RU107	No Finish	72















*When combined with Double Ceramic pressure balance cartridge.

	Description	SKU #	Color/Finish	List Price
	<p>Flash® Shower Rough-In Valve With PEX Inlets/Universal Outlets With Screwdriver Stops for Crimp Ring System</p> <ul style="list-style-type: none"> • ½" (13 mm) PEX crimp inlets/Universal outlets (ASTM F1807) • Cast DZR brass valve body • Flow rate: 5.1 gpm @ 45 psi* • Back-to-back capability • Includes flush plug with stainless steel ring • Includes screwdriver stops for easy servicing at the valve • Cartridge ships with trim • For use with TU series pressure balance bath/shower trim kits 	RU107SS	No Finish	103 
	<p>Flash® Shower Rough-In Valve With PEX Inlet Elbows/Universal Outlets for Crimp Ring System</p> <ul style="list-style-type: none"> • ½" (13 mm) PEX crimp elbow inlets/Universal outlets (ASTM F1807) • Cast DZR brass valve body • Flow rate: 5.1 gpm @ 45 psi* • Back-to-back capability • Includes flush plug with stainless steel ring • Cartridge ships with trim • For use with TU series pressure balance bath/shower trim kits 	RU107E	No Finish	95 
	<p>Flash® Shower Rough-In Valve With PEX Inlet Elbows/Universal Outlets With Screwdriver Stops for Crimp Ring System</p> <ul style="list-style-type: none"> • ½" (13 mm) PEX crimp elbow inlets/Universal outlets (ASTM F1807) • Cast DZR brass valve body • Flow rate: 5.1 gpm @ 45 psi* • Back-to-back capability • Includes flush plug with stainless steel ring • Includes screwdriver stops for easy servicing at the valve • Cartridge ships with trim • For use with TU series pressure balance bath/shower trim kits 	RU107ESS	No Finish	125 
	<p>Flash® Shower Rough-In Valve With PEX Inlets/Universal Outlets for Cold Expansion System</p> <ul style="list-style-type: none"> • ½" (13 mm) PEX cold expansion inlets/Universal outlets (ASTM F1960) • Cast DZR brass valve body • Flow rate: 5.1 gpm @ 45 psi* • Back-to-back capability • Includes flush plug with stainless steel ring • Cartridge ships with trim • For use with TU series pressure balance bath/shower trim kits 	RU108	No Finish	72 
	<p>Flash® Shower Rough-In Valve With PEX Inlets/Universal Outlets With Screwdriver Stops for Cold Expansion System</p> <ul style="list-style-type: none"> • ½" (13 mm) PEX cold expansion inlets/Universal outlets (ASTM F1960) • Cast DZR brass valve body • Flow rate: 5.1 gpm @ 45 psi* • Back-to-back capability • Includes flush plug with stainless steel ring • Includes screwdriver stops for easy servicing at the valve • For use with TU series pressure balance bath/shower trim kits 	RU108SS	No Finish	103 

*When combined with Double Ceramic pressure balance cartridge.

	Description	SKU #	Color/Finish	List Price
	<p>Flash® Shower Rough-In Valve With PEX Inlet Elbows/Universal Outlets for Cold Expansion System</p> <ul style="list-style-type: none"> • ½" (13 mm) PEX cold expansion elbow inlets/ Universal outlets (ASTM F1960) • Cast DZR brass valve body • Flow rate: 5.1 gpm @ 45 psi* • Back-to-back capability • Includes flush plug with stainless steel ring • Cartridge ships with trim • For use with TU series pressure balance bath/ shower trim kits 	RU108E	No Finish	95
	<p>Flash® Shower Rough-In Valve With PRX Inlet Elbows/Universal Outlets With Screwdriver Stops for Cold Expansion System</p> <ul style="list-style-type: none"> • ½" (13 mm) PEX cold expansion elbow inlets/ Universal outlets (ASTM F1960) • Cast DZR brass valve body • Flow rate: 5.1 gpm @ 45 psi* • Back-to-back capability • Includes flush plug with stainless steel ring • Includes screwdriver stops for easy servicing at the valve • Cartridge ships with trim • For use with TU series pressure balance bath/ shower trim kits 	RU108ESS	No Finish	125
	<p>Flash® Shower Rough-In Valve With CPVC Inlets/Universal Outlets</p> <ul style="list-style-type: none"> • ½" (13 mm) CPVC inlets/Universal outlets • Cast DZR brass valve body • Flow rate: 5.1 gpm @ 45 psi* • Back-to-back capability • Includes flush plug with stainless steel ring • Cartridge ships with trim • For use with TU series pressure balance bath/ shower trim kits 	RU109	No Finish	95
	<p>Flash® Shower Rough-In Valve With CPVC Inlets/Universal Outlets With Screwdriver Stops</p> <ul style="list-style-type: none"> • ½" (13 mm) CPVC inlets/Universal outlets • Cast DZR brass valve body • Flow rate: 5.1 gpm @ 45 psi* • Back-to-back capability • Includes flush plug with stainless steel ring • Includes screwdriver stops for easy servicing at the valve • Cartridge ships with trim • For use with TU series pressure balance bath/ shower trim kits 	RU109SS	No Finish	125

*When combined with Double Ceramic pressure balance cartridge.

	Description	SKU #	Color/Finish	List Price
	C Series 18-Inch Towel Bar	8337018.002	Polished Chrome	66
	• Brass bar	8337018.013	Polished Nickel	92
	• All metal construction	8337018.278	Legacy Bronze	100
	• Concealed mounting: no exposed set screws	8337018.295	Brushed Nickel	92
	• Easy to install			
	• Limited lifetime warranty on function and finish			
			 	
	C Series 24-Inch Towel Bar	8337024.002	Polished Chrome	70
	• Brass bar	8337024.013	Polished Nickel	98
	• All metal construction	8337024.278	Legacy Bronze	104
	• Concealed mounting: no exposed set screws	8337024.295	Brushed Nickel	98
	• Easy to install			
	• Limited lifetime warranty on function and finish			
			 	
	C Series Towel Ring	8337190.002	Polished Chrome	41
	• Concealed mounting with no exposed screws for a seamless appearance	8337190.013	Polished Nickel	57
	• Bushing on towel ring to prevent scratching and squeaking	8337190.278	Legacy Bronze	61
	• Easy to install	8337190.295	Brushed Nickel	57
	• 7" (178 mm) diameter ring			
	• Limited lifetime warranty on function and finish			
			 	
	C Series Double Robe Hook	8337210.002	Polished Chrome	31
	• All metal construction	8337210.013	Polished Nickel	43
	• Concealed mounting: no exposed set screws	8337210.278	Legacy Bronze	43
	• Easy to install	8337210.295	Brushed Nickel	43
	• Limited lifetime warranty on function and finish			
	• Solid metal construction is durable and long-lasting			
			 	
	C Series Toilet Paper Holder	8337230.002	Polished Chrome	53
	• All metal construction	8337230.013	Polished Nickel	76
	• Concealed mounting: no exposed set screws	8337230.278	Legacy Bronze	82
	• Easy to install	8337230.295	Brushed Nickel	76
	• Limited lifetime warranty on function and finish			
			 	

Lending stoic confidence to a modern setting, the **Serin Collection** features an arched faucet and substantial lever handles for a look that is as expressive as it is enduring.

Serin



Sink



Widespread Faucet
2064801



Widespread Faucet
2064831



Monoblock Faucet
2064101



Vessel Faucet
2064152



Wall-Mount Faucet
2064451

Bath



Contemporary
Freestanding Bathtub Faucet
T064951



Slip-on Diverter
Tub Spout
8888087

Bidet



Fixed Mounted
Bidet Fitting
2064401



Monoblock Bidet Fitting
2064011

Shower



Bath/Shower Trim Kit
TU064508



2-Handle Integrated
Shower Diverter Trim
TU064740



Accessories



C Series 18" Towel Bar
8337018



C Series 24" Towel Bar
8337024



C Series Towel Ring
8337190











C Series
Toilet Paper Holder
8337230







C Series
Double Robe Hook
8337210

Serin





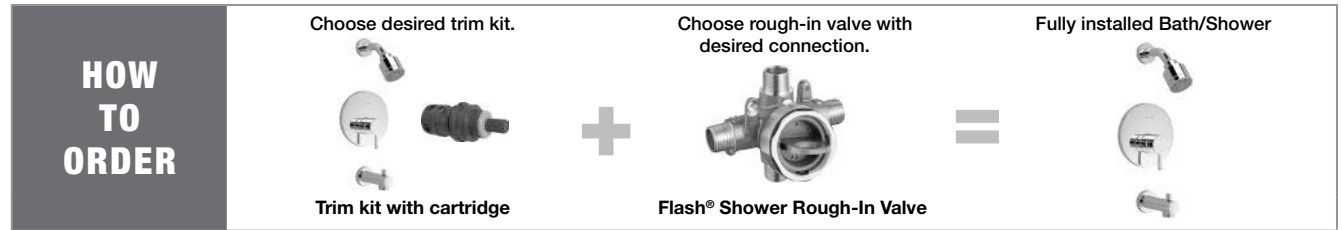

	Description	SKU #	Color/Finish	List Price
	<p>Serin® 2-Handle 8-Inch Widespread Bathroom Faucet 1.2 gpm 4.5 L/min With Lever Handles</p> <ul style="list-style-type: none"> • Brass construction • Washerless ceramic disc valve cartridge • Water-conserving 1.2 gpm/4.5 L/min pressure-compensating aerator • Brass sprout • Cast brass valve bodies with flexible hose connections for 6"-12" (152-305 mm) installations • Metal lever handles • Metal Speed Connect® pop-up drain 	<p>2064801.002</p>	<p>Polished Chrome</p>	<p>448</p>
	<p>Serin® 2-Handle 8-Inch Widespread Bathroom Faucet 1.2 gpm 4.5 L/min With Lever Handles</p> <ul style="list-style-type: none"> • Brass construction • Washerless ceramic disc valve cartridge • Water-conserving 1.2 gpm/4.5 L/min pressure-compensating aerator • Brass sprout • Cast brass valve bodies with flexible hose connections for 6"-12" (152-305 mm) installations • Metal lever handles • Metal Speed Connect® pop-up drain 	<p>2064831.002 2064831.295</p>	<p>Polished Chrome Brushed Nickel</p>	<p>448 628</p>
	<p>Serin® Single Hole Single-Handle Bathroom Faucet 1.2 gpm/4.5 L/min With Lever Handle</p> <ul style="list-style-type: none"> • Brass construction • Washerless ceramic disc valve cartridges • Water-conserving 1.2 gpm/4.5 L/min pressure-compensating aerator • Cast brass spout • Braided flexible hoses with 3/8" (10mm) compression connectors • Adjustable Hot Limit Safety Stop • Red/Blue index buttons included • Metal lever handle • Metal Speed Connect® pop-drain 	<p>2064101.002 2064101.295</p>	<p>Polished Chrome Brushed Nickel</p>	<p>343 481</p>
	<p>Serin® Single Hole Single-Handle Bathroom Faucet 1.2 gpm/4.5 L/min With Lever Handle Less Drain</p> <ul style="list-style-type: none"> • Brass construction • Washerless ceramic disc valve cartridges • Water-conserving 1.0 gpm/3.8 L/min pressure-compensating aerator • Cast brass spout • Braided flexible hoses with 3/8" (10mm) compression connectors • Adjustable Hot Limit Safety Stop • Red/Blue index buttons included • Metal lever handle • Less pop-up drain and hole 	<p>2064LDH101.002</p>	<p>Polished Chrome</p>	<p>319</p>

	Description	SKU #	Color/Finish	List Price
 	<p>Serin® Single Hole Single-Handle Bathroom Faucet 1.2 gpm/4.5 L/min With Lever Handle</p> <ul style="list-style-type: none"> • Brass construction • Washerless ceramic disc valve cartridges • Water-conserving 1.0 gpm/3.8 L/min pressure-compensating aerator • Cast brass spout • Braided flexible hoses with 3/8" (10mm) compression connectors • Metal lever handle • Metal Speed Connect® pop-up drain 	  <p>2064131.002</p>	<p>Polished Chrome</p>	<p>259</p>
 	<p>Serin® Single Hole Single-Handle Vessel Sink Faucet 1.2 gpm/4.5 L/min With Lever Handle</p> <ul style="list-style-type: none"> • Brass construction • Washerless ceramic disc valve cartridges • Water-conserving 1.0 gpm/3.8 L/min pressure-compensating aerator • Cast brass spout • Braided flexible hoses with 3/8" (10mm) compression connectors • Metal lever handle • Metal Speed Connect® pop-up drain 	  <p>2064131.295</p>	<p>Brushed Nickel</p>	<p>360</p>
 	<p>Serin® Single Hole Single-Handle Vessel Sink Faucet 1.2 gpm/4.5 L/min With Lever Handle</p> <ul style="list-style-type: none"> • Brass construction • Washerless ceramic disc valve cartridges • Water-conserving 1.2 gpm/4.5 L/min pressure-compensating aerator • Cast brass spout • Braided flexible hoses with 3/8" (10 mm) compression connectors • Red/Blue index buttons included • Metal lever handle • Grid drain 	  <p>2064152.002</p>	<p>Polished Chrome</p>	<p>412</p>
 	<p>Serin® Single Hole Single-Handle Vessel Sink Faucet 1.2 gpm/4.5 L/min With Lever Handle</p> <ul style="list-style-type: none"> • Brass construction • Washerless ceramic disc valve cartridges • Water-conserving 1.2 gpm/4.5 L/min pressure-compensating aerator • Cast brass spout • Braided flexible hoses with 3/8" (10 mm) compression connectors • Red/Blue index buttons included • Metal lever handle • Less drain 	  <p>2064151.002</p>	<p>Polished Chrome</p>	<p>378</p>
 	<p>Serin® 2-Handle Wall Mount Faucet 1.2 gpm/4.5 L/min With Lever Handles</p> <ul style="list-style-type: none"> • Brass construction • Washerless ceramic disc valve cartridges • Water-conserving 1.2 gpm/4.5 L/min pressure-compensating aerator • Brass spout • Cast brass valve body • Metal lever handles • Grid drain 	  <p>2064451.002</p>	<p>Polished Chrome</p>	<p>448</p>











Serin

	Description	SKU #	Color/Finish	List Price
	<p>Serin® Single-Handle Wall Mount Faucet 1.2 gpm/4.5 L/min With Lever Handles</p> <ul style="list-style-type: none"> • Brass construction • Washerless ceramic disc valve cartridge • Water-conserving 1.2 gpm/4.5 L/min pressure-compensating aerator • Brass sprout • Cast brass valve body • Metal lever handles • Grid drain 	<p>2064461.002</p>	<p>Polished Chrome</p>	<p>448</p>
	<p>Contemporary Round Freestanding Bathtub Filler With Lever Handle Faucet for Flash® Rough-In Valve</p> <ul style="list-style-type: none"> • Brass construction and ¼-turn washerless ceramic disc valve cartridge • Personal shower features 59" (1499 mm) long hose with 1.8 gpm/6.8 L/min maximum flow • Metal lever handle • Overall height: 44-¾" (1137 mm) • Spout reach: 11-¼" (286 mm) • Metal hand shower • Shower bracket pivots 60° • For use with Flash® freestanding tub faucet rough-in valve (sold separately) 	<p>T064951.002 T064951.243 T064951.295</p>	<p>Polished Chrome Matte Black Brushed Nickel</p>	<p>1,187 1,780 1,662</p>
	<p>Flash® Freestanding Bathtub Filler Rough-In Valve</p> <ul style="list-style-type: none"> • Brass construction • ½" (13 mm) copper inlets • Level adjustable • Test plugs included • Must order trim separately 	<p>R950</p>	<p>No Finish</p>	<p>230</p>
	<p>Flash® Freestanding Bathtub Filler Rough-In Valve With Screwdriver Stops</p> <ul style="list-style-type: none"> • Brass construction • ½" (13 mm) copper inlets • Level adjustable • Test plugs included • Must order trim separately • Includes screwdriver stops for easy servicing at the valve 	<p>R950SS</p>	<p>No Finish</p>	<p>265</p>



	Description	SKU #	Color/Finish	List Price
 	Serin® 1.75 gpm/6.6 L/min Tub and Shower Trim Kit With Water-Saving 3-Function Shower Head, Double Ceramic Pressure Balance Cartridge With Lever Handle <ul style="list-style-type: none"> • Includes Double Ceramic pressure balance cartridge • Water-saving 4-3/4" (120mm) 3-function showerhead, 1.75 gpm/6.6 L/min maximum flow • Shower arm and flange • Brass wall escutcheon • Metal lever handle • For use with Flash® shower rough-in valves 	 TU064508.002	Polished Chrome	402
		TU064508.295	Brushed Nickel	549
 	Serin® 1.75 gpm/6.6 L/min Tub and Shower Trim Kit With Water-Saving 3-Function Shower Head, Double Ceramic Pressure Balance Cartridge With Lever Handle <ul style="list-style-type: none"> • Includes Double Ceramic pressure balance cartridge • Water-saving 4-3/4" (120mm) 3-function showerhead, 1.75 gpm/6.6 L/min maximum flow • Shower arm and flange • Brass wall escutcheon • Metal lever handle • For use with Flash® shower rough-in valves 	  TU064507.002	Polished Chrome	356
	Serin® Valve Only Trim Kit With Double Ceramic Pressure Balance Cartridge With Lever Handle <ul style="list-style-type: none"> • Includes Double Ceramic pressure balance cartridge • Brass wall escutcheon • Metal lever handle • For use with Flash® shower rough-in valves 	 TU064500.002	Polished Chrome	264
		TU064500.295	Brushed Nickel	356









Serin

	Description	SKU #	Color/Finish	List Price
	<p>Flash® Shower Rough-In Valve With Universal Inlets/Outlets</p> <ul style="list-style-type: none"> • ½" (13 mm) male NPT/Sweat inlets/outlets accept ½" copper, ½" iron pipe, PEX or CPVC adapters • Cast DZR brass valve body • Flow rate: 5.1 gpm @ 45 psi* • Back-to-back capability • Includes flush plug with stainless steel ring • Cartridge ships with trim • For use with TU series pressure balance bath/shower trim kits 	RU101	No Finish	72 
	<p>Flash® Shower Rough-In Valve With Universal Inlets/Outlets With Screwdriver Stops</p> <ul style="list-style-type: none"> • ½" (13 mm) male NPT/Sweat inlets/outlets accept ½" copper, ½" iron pipe, PEX or CPVC adapters • Cast DZR brass valve body • Flow rate: 5.1 gpm @ 45 psi* • Back-to-back capability • Includes flush plug with stainless steel ring • Includes screwdriver stops for easy servicing at the valve • For use with TU series pressure balance bath/shower trim kits 	RU101SS	No Finish	103 
	<p>Flash® Shower Rough-In Valve With Stub-Outs</p> <ul style="list-style-type: none"> • ½" (13 mm) Stub-out inlets/outlets accept ½" press-connect fittings • Cast DZR brass valve body • Flow rate: 5.1 gpm @ 45 psi* • Back-to-back capability • Includes flush plug with stainless steel ring • Cartridge ships with trim • For use with TU series pressure balance bath/shower trim kits 	RU102	No Finish	72 
	<p>Flash® Shower Rough-In Valve With Stub-Outs With Screwdriver Stops</p> <ul style="list-style-type: none"> • ½" (13 mm) Stub-out inlets/outlets accept ½" press-connect fittings • Cast DZR brass valve body • Flow rate: 5.1 gpm @ 45 psi* • Back-to-back capability • Includes flush plug with stainless steel ring • Includes screwdriver stops for easy servicing at the valve • Cartridge ships with trim • For use with TU series pressure balance bath/shower trim kits 	RU102SS	No Finish	103 
	<p>Flash® Shower Rough-In Valve With PEX Inlets/Universal Outlets for Crimp Ring System</p> <ul style="list-style-type: none"> • ½" (3 mm) PEX crimp inlets/Universal outlets (ASTM F1807) • Cast DZR brass valve body • Flow rate: 5.1 gpm @ 45 psi* • Back-to-back capability • Includes flush plug with stainless steel ring • Cartridge ships with trim • For use with TU series pressure balance bath/shower trim kits 	RU107	No Finish	72 

*When combined with Double Ceramic pressure balance cartridge.

	Description	SKU #	Color/Finish	List Price
	<p>Flash® Shower Rough-In Valve With PEX Inlets/Universal Outlets With Screwdriver Stops for Crimp Ring System</p> <ul style="list-style-type: none"> • ½" (13 mm) PEX crimp inlets/Universal outlets (ASTM F1807) • Cast DZR brass valve body • Flow rate: 5.1 gpm @ 45 psi* • Back-to-back capability • Includes flush plug with stainless steel ring • Includes screwdriver stops for easy servicing at the valve • Cartridge ships with trim • For use with TU series pressure balance bath/shower trim kits 	RU107SS	No Finish	103 
	<p>Flash® Shower Rough-In Valve With PEX Inlet Elbows/Universal Outlets for Crimp Ring System</p> <ul style="list-style-type: none"> • ½" (13 mm) PEX crimp elbow inlets/Universal outlets (ASTM F1807) • Cast DZR brass valve body • Flow rate: 5.1 gpm @ 45 psi* • Back-to-back capability • Includes flush plug with stainless steel ring • Cartridge ships with trim • For use with TU series pressure balance bath/shower trim kits 	RU107E	No Finish	95 
	<p>Flash® Shower Rough-In Valve With PEX Inlet Elbows/Universal Outlets With Screwdriver Stops for Crimp Ring System</p> <ul style="list-style-type: none"> • ½" (13 mm) PEX crimp elbow inlets/Universal outlets (ASTM F1807) • Cast DZR brass valve body • Flow rate: 5.1 gpm @ 45 psi* • Back-to-back capability • Includes flush plug with stainless steel ring • Includes screwdriver stops for easy servicing at the valve • Cartridge ships with trim • For use with TU series pressure balance bath/shower trim kits 	RU107ESS	No Finish	125 
	<p>Flash® Shower Rough-In Valve With PEX Inlets/Universal Outlets for Cold Expansion System</p> <ul style="list-style-type: none"> • ½" (13 mm) PEX cold expansion inlets/Universal outlets (ASTM F1960) • Cast DZR brass valve body • Flow rate: 5.1 gpm @ 45 psi* • Back-to-back capability • Includes flush plug with stainless steel ring • Cartridge ships with trim • For use with TU series pressure balance bath/shower trim kits 	RU108	No Finish	72 
	<p>Flash® Shower Rough-In Valve With PEX Inlets/Universal Outlets With Screwdriver Stops for Cold Expansion System</p> <ul style="list-style-type: none"> • ½" (13 mm) PEX cold expansion inlets/Universal outlets (ASTM F1960) • Cast DZR brass valve body • Flow rate: 5.1 gpm @ 45 psi* • Back-to-back capability • Includes flush plug with stainless steel ring • Includes screwdriver stops for easy servicing at the valve • For use with TU series pressure balance bath/shower trim kits 	RU108SS	No Finish	103 

*When combined with Double Ceramic pressure balance cartridge.

	Description	SKU #	Color/Finish	List Price
	<p>Flash® Shower Rough-In Valve With PEX Inlet Elbows/Universal Outlets for Cold Expansion System</p> <ul style="list-style-type: none"> • ½" (13 mm) PEX cold expansion elbow inlets/ Universal outlets (ASTM F1960) • Cast DZR brass valve body • Flow rate: 5.1 gpm @ 45 psi* • Back-to-back capability • Includes flush plug with stainless steel ring • Cartridge ships with trim • For use with TU series pressure balance bath/ shower trim kits 	RU108E	No Finish	95 
	<p>Flash® Shower Rough-In Valve With PRX Inlet Elbows/Universal Outlets With Screwdriver Stops for Cold Expansion System</p> <ul style="list-style-type: none"> • ½" (13 mm) PEX cold expansion elbow inlets/ Universal outlets (ASTM F1960) • Cast DZR brass valve body • Flow rate: 5.1 gpm @ 45 psi* • Back-to-back capability • Includes flush plug with stainless steel ring • Includes screwdriver stops for easy servicing at the valve • Cartridge ships with trim • For use with TU series pressure balance bath/ shower trim kits 	RU108ESS	No Finish	125 
	<p>Flash® Shower Rough-In Valve With CPVC Inlets/Universal Outlets</p> <ul style="list-style-type: none"> • ½" (13 mm) CPVC inlets/Universal outlets • Cast DZR brass valve body • Flow rate: 5.1 gpm @ 45 psi* • Back-to-back capability • Includes flush plug with stainless steel ring • Cartridge ships with trim • For use with TU series pressure balance bath/ shower trim kits 	RU109	No Finish	95 
	<p>Flash® Shower Rough-In Valve With CPVC Inlets/Universal Outlets With Screwdriver Stops</p> <ul style="list-style-type: none"> • ½" (13 mm) CPVC inlets/Universal outlets • Cast DZR brass valve body • Flow rate: 5.1 gpm @ 45 psi* • Back-to-back capability • Includes flush plug with stainless steel ring • Includes screwdriver stops for easy servicing at the valve • Cartridge ships with trim • For use with TU series pressure balance bath/ shower trim kits 	RU109SS	No Finish	125 

*When combined with Double Ceramic pressure balance cartridge.

	Description	SKU #	Color/Finish	List Price
	<p>Serin® Tub and Shower Trim Kit, Double Ceramic Pressure Balance Cartridge With Lever Handle</p> <ul style="list-style-type: none"> • Includes Double Ceramic pressure balance cartridge • Shower arm and flange • Brass wall escutcheon with built-in diverter • Metal lever handle • Brass tub spout • Red/Blue indicator ring • For use with rough-in valve R116SS • Brass wall escutcheon with built-in diverter 	T064WDXH602.002	Polished Chrome	405 
	<p>Temperature Control Rough-In Valve With Integral Diverter</p> <ul style="list-style-type: none"> • Ceramic disc valve provides a lifetime of smooth handle operation and drip-free performance • Hot Limit Safety Stop protects from accidental scalding • Durable brass construction • Limited lifetime warranty on function and finish 	R116SS	No Finish	184 
	<p>Serin® Fixture-Mounted Bidet Fitting</p> <ul style="list-style-type: none"> • Cast brass valve bodies • Washerless ceramic disc valve cartridges • Vacuum breaker • Metal lever handle • Metal Speed Connect® pop-up drain 	2064401.002	Polished Chrome	766 
	<p>Serin® Monoblock Bidet Fitting</p> <ul style="list-style-type: none"> • Cast brass spout • Braided flexible hoses with 3/8" (10 mm) compression connectors • Metal lever handle • Metal Speed Connect® pop-up drain 	2064011.002	Polished Chrome	363 

	Description	SKU #	Color/Finish	List Price
	<p>Serin® 2-Handle Integrated Shower Diverter Trim Only</p> <ul style="list-style-type: none"> • Metal wall escutcheon • Metal lever handles • Works with Flash® 2-Way Integrated Shower Diverter Rough-In Valve with Pressure Balance Valve Cartridge, required and sold separately • Flash® 2-Way Integrated Shower Diverter Rough-In Valve RU521 ships with a 2-way Discrete cartridge • 2-Way Shared capability requires Flash® 2-Way Integrated Shower Diverter Rough-In Valve RU521, plus a 2-Way Shared pressure balance cartridge #M970720-0070A, sold separately • Flash® 3-Way Integrated Shower Diverter Rough-In Valve RU531 ships with a 3-Way Discrete cartridge • 3-Way Shared capability requires Flash® 3-Way Integrated Shower Diverter Rough-In Valve RU531, plus a 3-Way Shared pressure balance cartridge #M970730-0070A, sold separately • 3-way diverter with shared flow requires cartridge M970730-0070A (sold separately) 	<p>ADA</p> <p>TU064740.002 TU064740.295</p>	<p>Polished Chrome Brushed Nickel</p>	<p>264 370</p> 
	<p>Flash® 2-Way Integrated Shower Diverter Rough-In Valve with Pressure Balance Valve Cartridge</p> <ul style="list-style-type: none"> • Made of casted DZR brass to resist corrosion • For use with Flash® 2-Handle Integrated Shower Diverter Trim • ½" NPT Inlets/Outlets • Valve ships with a 2-Way Discrete pressure balance cartridge • 2-Way Shared functionality requires RU521 valve, plus purchase of 2-Way Shared cartridge RP# M970720-0070A, sold separately • Compatible with Delancey®, Serin®, Studio® S, Town Square® S, Times Square® and Townsend® trims • Trim sold separately 	<p>RU521</p>	<p>No Finish</p>	<p>355</p> 
	<p>Flash® 2-Way Shared Diverter Cartridge</p> <ul style="list-style-type: none"> • For use with RU521 valve 	<p>M970720-0070A</p>	<p>No Finish</p>	<p>79</p>
	<p>Flash® 3-Way Integrated Shower Diverter Rough-In Valve with Pressure Balance Valve Cartridge</p> <ul style="list-style-type: none"> • Made of casted DZR brass to resist corrosion • For use with Flash® 2-Handle Integrated Shower Diverter Trim • ½" NPT Inlets/Outlets • Valve ships with a 3-Way Discrete pressure balance cartridge • 3-Way Shared functionality requires RU531 valve, plus purchase of 3-Way Shared cartridge RP# M970730-0070A, sold separately • Compatible with Delancey®, Serin®, Studio® S, Town Square® S, Times Square® and Townsend® trims • Trim sold separately 	<p>RU531</p>	<p>No Finish</p>	<p>385</p> 
	<p>Flash® 3-Way Shared Diverter Cartridge</p> <ul style="list-style-type: none"> • For use with RU531 valve 	<p>M970730-0070A</p>	<p>No Finish</p>	<p>79</p>

	Description	SKU #	Color/Finish	List Price
	Serin® Single-Handle Diverter Valve Trim Kit		T064430.002 Polished Chrome	118
	<ul style="list-style-type: none"> • Metal lever handle • Less valve (must be purchased separately) • For use with rough-in valves R422, R422S, R433 and R433S • Controls water flow between 2 or 3 outlets (shower or sprays) 		T064430.295 Brushed Nickel	163  
	2-Way In-Wall Diverter Rough-In Valve With 2 Discrete Functions	R422	No Finish	231  
	<ul style="list-style-type: none"> • Durable cast brass valve body – excellent for high use applications with prolonged water use • Controls water flow between 2 outlets (shower or sprays) • ½" (13 mm) NPT inlets/outlets • Trim must be ordered separately 			
	2-Way In-Wall Diverter Rough-In Valve With 2 Discrete/1 Shared Function	R422S	No Finish	231  
	<ul style="list-style-type: none"> • Durable cast brass valve body – excellent for high use applications with prolonged water use • Controls water flow between 2 outlets (shower or sprays) • ½" (13 mm) NPT inlets/outlets • Trim must be ordered separately 			
	3-Way In-Wall Diverter Rough-In Valve With 3 Discrete Functions	R433	No Finish	262  
	<ul style="list-style-type: none"> • Durable cast brass valve body – excellent for high use applications with prolonged water use • Controls water flow between 3 outlets (shower or sprays) • ½" (13 mm) NPT inlets/outlets • Trim must be ordered separately 			
	3-Way In-Wall Diverter Rough-In Valve With 3 Discrete/3 Shared Functions	R433S	No Finish	262  
	<ul style="list-style-type: none"> • Durable cast brass valve body – excellent for high use applications with prolonged water use • Controls water flow between 3 outlets (shower or sprays) • ½" (13 mm) NPT inlets/outlets • Trim must be ordered separately 			

Serin Flash® Pressure Balance Bath/Shower System

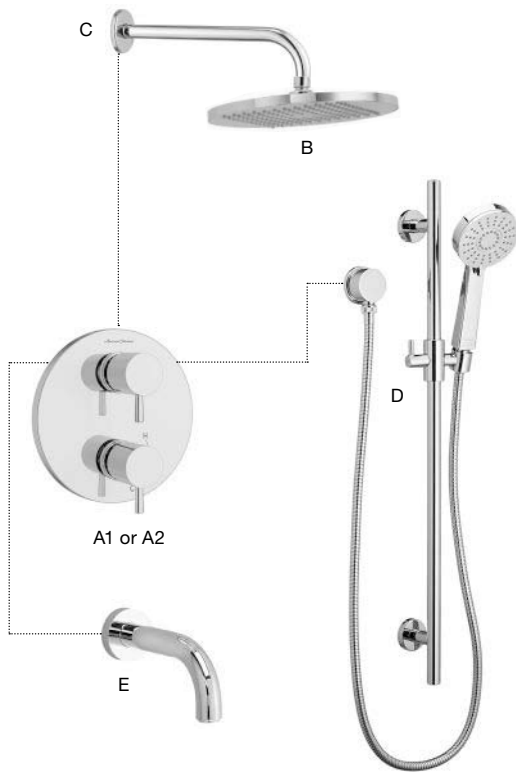

Serin Flash Pressure Balance Shower System

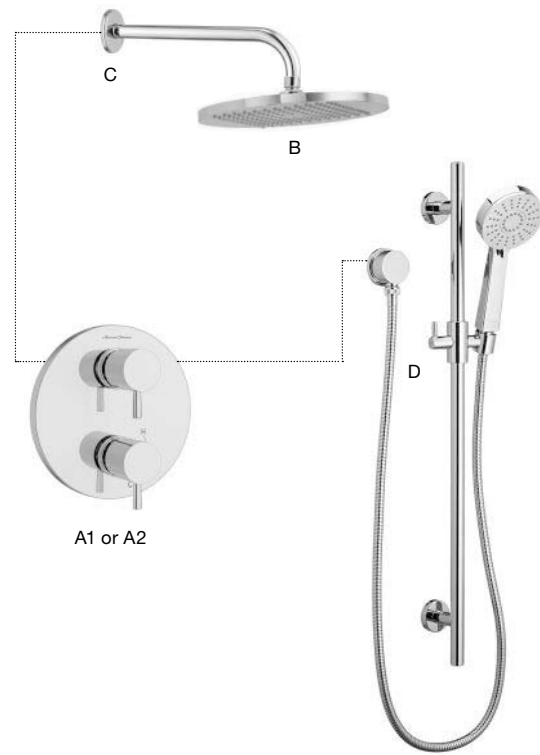

Serin Pressure Balance Bath/Shower System

DESCRIPTION				QTY	SKU #	LIST PRICE FOR SYSTEM
						002
A	Serin Flash 2-Handle Integrated Shower Diverter Trim	1	TU064740			264
B	10" Modern Rain Showerhead	1	1660683			296
C	12" Wall-Mount Right Angle Shower Arm	1	1660194			101
D	3-Function Modern Slide Bar Kit	1	1662647			312
E	Serin Tub Spout	1	8888421			130

Required Components – Choose From Rough-In Valve 1 or 2 (not shown)















1	3-Way Discrete (Non-Shared) Functionality – Requires Flash 3-Way Integrated Shower Diverter Rough-In Valve with Pressure Balance Valve Cartridge	1	RU531			385
2	3-Way (Shared) Functionality – Requires Flash 3-Way Integrated Shower Diverter Rough-In Valve with Pressure Balance Valve Cartridge, also requires 3-way shared function cartridge M970730-0070A (sold separately)	1	RU531 + M970730-0070A			385 + 79 = 464
3-Way Discrete (Non-Shared) Bath/Shower System Total						1,488
3-Way (Shared) Bath/Shower System Total						1,567

Serin Pressure Balance Shower System

DESCRIPTION				QTY	SKU #	LIST PRICE FOR SYSTEM
						002
A	Serin Flash 2-Handle Integrated Shower Diverter Trim	1	TU064740			249
B	10" Modern Rain Showerhead	1	1660683			296
C	12" Wall-Mount Right Angle Shower Arm	1	1660194			101
D	3-Function Modern Slide Bar Kit	1	1662647			312

Required Components – Choose From Rough-In Valve 1 or 2 (not shown)

1	2-Way Discrete (Non-Shared) Functionality – Requires Flash 2-Way Integrated Shower Diverter Rough-In Valve with Pressure Balance Valve Cartridge	1	RU521			355
2	2-Way (Shared) Functionality – Requires Flash 2-Way Integrated Shower Diverter Rough-In Valve with Pressure Balance Valve Cartridge, also requires 2-way shared function cartridge M970720-0070A (sold separately)	1	RU521 + M970720-0070A			355 + 79 = 434
2-Way Discrete (Non-Shared) Bath/Shower System Total						1,313
2-Way (Shared) Bath/Shower System Total						1,392

	Description	SKU #	Color/Finish	List Price
	C Series 18-Inch Towel Bar	8337018.002	Polished Chrome	66
	• Brass bar	8337018.013	Polished Nickel	92
	• All metal construction	8337018.278	Legacy Bronze	100
	• Concealed mounting: no exposed set screws	8337018.295	Brushed Nickel	92
	• Easy to install			
	• Limited lifetime warranty on function and finish			
 				
	C Series 24-Inch Towel Bar	8337024.002	Polished Chrome	70
	• Brass bar	8337024.013	Polished Nickel	98
	• All metal construction	8337024.278	Legacy Bronze	104
	• Concealed mounting: no exposed set screws	8337024.295	Brushed Nickel	98
	• Easy to install			
	• Limited lifetime warranty on function and finish			
 				
	C Series Towel Ring	8337190.002	Polished Chrome	41
	• Concealed mounting with no exposed screws for a seamless appearance	8337190.013	Polished Nickel	57
	• Bushing on towel ring to prevent scratching and squeaking	8337190.278	Legacy Bronze	61
	• Easy to install	8337190.295	Brushed Nickel	57
	• 7" (178 mm) diameter ring			
	• Limited lifetime warranty on function and finish			
 				
	C Series Double Robe Hook	8337210.002	Polished Chrome	31
	• All metal construction	8337210.013	Polished Nickel	43
	• Concealed mounting: no exposed set screws	8337210.278	Legacy Bronze	43
	• Easy to install	8337210.295	Brushed Nickel	43
	• Limited lifetime warranty on function and finish			
	• Solid metal construction is durable and long-lasting			
 				
	C Series Toilet Paper Holder	8337230.002	Polished Chrome	53
	• All metal construction	8337230.013	Polished Nickel	76
	• Concealed mounting: no exposed set screws	8337230.278	Legacy Bronze	82
	• Easy to install	8337230.295	Brushed Nickel	76
	• Limited lifetime warranty on function and finish			
 				

The urban-inspired **Studio S Collection** is defined by soft contours, superior performance, and lasting durability. It's the perfect fusion of style and function for today's modern bathroom.



Studio S

Sink



Widespread Faucet
7105857



Widespread Faucet
7105801



Vessel Faucet
7105172



Monoblock Faucet
7105121

Bath



Bathtub Faucets
T105900, T105901



Contemporary
Freestanding Bathtub Faucet
T064951



Tub Spouts

Shower



Bath/Shower Trim Kits
TU105508



Diverter Trim Kit
T105430



2-Handle Integrated
Shower Diverter Trim
TU105740

Accessories



Studio S
18" Towel Bar
7105018



Studio S
24" Towel Bar
7105024



Studio S
Towel Ring
7105190







Studio S
Toilet Paper Holder
7105230







Studio S
Double Robe Hook
7105210

Studio S









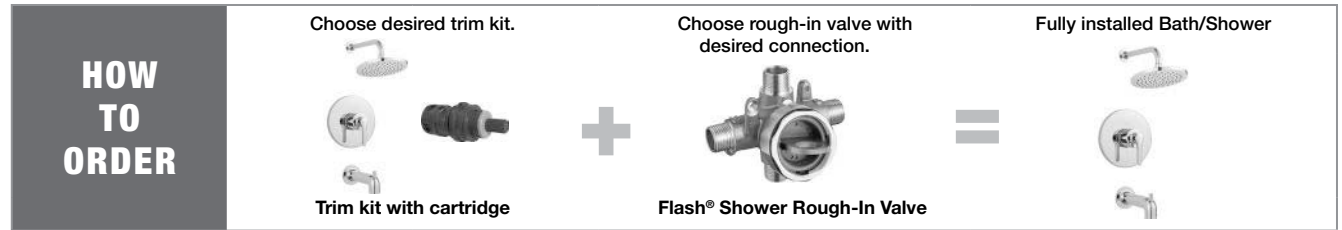











	Description	SKU #	Color/Finish	List Price
 	<ul style="list-style-type: none"> • Brass construction and washerless ceramic disc valve • Water-conserving 1.2 gpm/4.5 L/min pressure-compensating aerator • Valve bodies with integrated flexible hose connections for 6"-12" (152-305 mm) installation • Metal lever handles • Brass push pop-up drain 	 7105857.002	Polished Chrome	496
		7105857.243	Matte Black	744
		7105857.295	Brushed Nickel	695
		7105857.GN0	Polished Chrome	
 	<ul style="list-style-type: none"> • Brass construction and washerless ceramic disc valve • Water-conserving 1.2 gpm/4.5 L/min pressure-compensating aerator • Valve bodies with integrated flexible hose connections for 6"-12" (152-305 mm) installation • Metal knob handles • Brass push pop-up drain 	 7105877.002	Polished Chrome	496
		7105877.243	Matte Black	744
		7105877.295	Brushed Nickel	695
 	<ul style="list-style-type: none"> • Brass construction and washerless ceramic disc valve • Water-conserving 1.2 gpm/4.5 L/min pressure-compensating aerator • Valve bodies with integrated flexible hose connections for 6"-12" (152-305 mm) installation • Metal lever handles • Brass Push Pop-Up Drain 	 7105801.002	Polished Chrome	496
		7105801.243	Matte Black	744
		7105801.295	Brushed Nickel	695
 	<ul style="list-style-type: none"> • Brass construction and washerless ceramic disc valve • Water-conserving 1.2 gpm/4.5 L/min pressure-compensating aerator • Valve bodies with integrated flexible hose connections for 6"-12" (152-305 mm) installation • Metal knob handles • Brass Push Pop-Up Drain 	 7105821.002	Polished Chrome	496
		7105821.243	Matte Black	744
		7105821.295	Brushed Nickel	695
 	<ul style="list-style-type: none"> • Brass construction and washerless ceramic disc valve cartridge • Water-conserving 1.2 gpm/4.5 L/min pressure-compensating aerator • Braided flexible hoses with 3/8" (10 mm) compression connectors • Metal lever handle • Brass push pop-up drain 	 7105121.002	Polished Chrome	345
		7105121.243	Matte Black	516
		7105121.295	Brushed Nickel	410

	Description	SKU #	Color/Finish	List Price
	<p>Studio® S Single Hole Single-Handle Vessel Sink Faucet 1.2 gpm/4.5 L/min With Lever Handle</p> <ul style="list-style-type: none"> • Brass construction and washerless ceramic disc valve cartridges • Water-conserving 1.2 gpm/4.5 L/min pressure-compensating aerator • Braided flexible hoses with 3/8" (10 mm) compression connectors • Metal Lever Handle • Metal grid drain 	<p>7105172.002 7105172.243 7105172.295</p>	<p>Polished Chrome Matte Black Brushed Nickel</p>	<p>414 621 580</p>
	<p>Universal Deck Plate</p> <ul style="list-style-type: none"> • Metal construction • Putty plate included 	<p>2064101P.243</p>	<p>Matte Black</p>	<p>68</p>
	<p>Studio® S Bathtub Faucet With Lever Handles and Personal Shower for Flash® Rough-In Valve</p> <ul style="list-style-type: none"> • Brass construction • Metal lever handles • Personal shower with 1.8 gpm/6.8 L/min maximum flow • Personal showers feature 5' (152 cm) long hose • For use with Flash® bathtub faucet rough-in valve R910 • Valve sold separately 	<p>T105901.002 T105901.243 T105901.295</p>	<p>Polished Chrome Matte Black Brushed Nickel</p>	<p>602 903 844</p>
	<p>Studio® S Bathtub Faucet With Lever Handles for Flash® Rough-In Valve</p> <ul style="list-style-type: none"> • Brass construction • Metal lever handles • Less personal shower • For use with Flash® bathtub faucet rough-in valve R900 • Valve sold separately 	<p>T105900.002 T105900.243 T105900.295</p>	<p>Polished Chrome Matte Black Brushed Nickel</p>	<p>422 633 590</p>
	<p>Flash® Bathtub Filler Rough-In Valve With Personal Shower</p> <ul style="list-style-type: none"> • Brass construction and washerless ¼-turn ceramic disc valves cartridge • ½" (13 mm) copper inlets • Connections to spout can be made via flexible hoses (provided) or ½" (13 mm) copper sweat connections • 14 gpm/59.2 L/min maximum flow rate at 40 psi • 8"-16" (203-406 mm) flexible installation • Adjustable rough-in: 2-½" (64 mm) maximum deck thickness • Includes hand shower rough-in 	<p>R910</p>	<p>No Finish</p>	<p>322</p>

Studio S

	Description	SKU #	Color/Finish	List Price
	<p>Flash® Bathtub Filler Rough-In Valve</p> <ul style="list-style-type: none"> • Brass construction and washerless ¼-turn ceramic disc valve cartridges • ½" (13 mm) copper inlets • Connections to spout can be made via flexible hoses (provided) or ½" (13 mm) copper sweat connections • 14 gpm/52.9 L/min maximum flow rate at 40 psi • 8"-16" (203-406 mm) flexible installation • Adjustable rough-in: 2-½" (64 mm) maximum deck thickness 	R900	No Finish	184
	<p>Contemporary Round Freestanding Bathtub Filler With Lever Handle Faucet for Flash® Rough-In Valve</p> <ul style="list-style-type: none"> • Brass construction and ¼-turn washerless ceramic disc valve cartridge • Personal shower features 59" (1499 mm) long hose with 1.8 gpm/6.8 L/min maximum flow • Metal lever handle • Overall height: 44-¾" (1137 mm) • Spout reach: 11-¼" (286 mm) • Metal hand shower • Shower bracket pivots 60° • For use with Flash® freestanding tub faucet rough-in valve (sold separately) 	<p>T064951.002 T064951.243 T064951.295</p>	<p>Polished Chrome Matte Black Brushed Nickel</p>	<p>1,187 1,780 1,662</p>
	<p>Flash® Freestanding Bathtub Filler Rough-In Valve</p> <ul style="list-style-type: none"> • Brass construction • ½" (13 mm) copper inlets • Level adjustable • Test plugs included • Must order trim separately 	R950	No Finish	230
	<p>Flash® Freestanding Bathtub Filler Rough-In Valve With Screwdriver Stops</p> <ul style="list-style-type: none"> • Brass construction • ½" (13 mm) copper inlets • Level adjustable • Test plugs included • Must order trim separately • Includes screwdriver stops for easy servicing at the valve 	R950SS	No Finish	265











	Description	SKU #	Color/Finish	List Price
   	Studio® S 1.8 gpm/6.8 L/min Tub and Shower Trim Kit With Rain Showerhead, Double Ceramic Pressure Balance Cartridge With Lever Handle <ul style="list-style-type: none"> • Includes Double Ceramic pressure balance cartridge • Water-saving 8" (200 mm) rain showerhead, 1.8 gpm/6.8 L/min maximum flow • 12" (300 mm) shower arm and flange • Brass wall escutcheon • Metal lever handle • Slip-on diverter tub spout • For use with Flash® shower rough-in valves 	 TU105508.002	Polished Chrome	385
		TU105508.243	Matte Black	564
		TU105508.295	Brushed Nickel	526
			  	
  	Studio® S 1.8 gpm/6.8 L/min Shower Trim Kit With Rain Showerhead, Double Ceramic Pressure Balance Cartridge With Lever Handle <ul style="list-style-type: none"> • Includes Double Ceramic pressure balance cartridge • Water-saving 8" (200 mm) rain showerhead, 1.8 gpm/6.8 L/min maximum flow • 12" (300 mm) shower arm and flange • Brass wall escutcheon • Metal lever handle • For use with Flash® shower rough-in valves 	 TU105507.002	Polished Chrome	342
		TU105507.243	Matte Black	501
		TU105507.295	Brushed Nickel	467
			  	
	Studio® S Valve Only Trim Kit With Double Ceramic Pressure Balance Cartridge With Lever Handle <ul style="list-style-type: none"> • Includes Double Ceramic pressure balance cartridge • Brass wall escutcheon • Metal lever handle • For use with Flash® shower rough-in valves 	 TU105500.002	Polished Chrome	254
		TU105500.243	Matte Black	367
		TU105500.295	Brushed Nickel	342
			  	

Studio S

	Description	SKU #	Color/Finish	List Price	
	<p>Flash® Shower Rough-In Valve With Universal Inlets/Outlets</p> <ul style="list-style-type: none"> • ½" (13 mm) male NPT/Sweat inlets/outlets accept ½" copper, ½" iron pipe, PEX or CPVC adapters • Cast DZR brass valve body • Flow rate: 5.1 gpm @ 45 psi* • Back-to-back capability • Includes flush plug with stainless steel ring • Cartridge ships with trim • For use with TU series pressure balance bath/shower trim kits 	RU101	No Finish	72	
	<p>Flash® Shower Rough-In Valve With Universal Inlets/Outlets With Screwdriver Stops</p> <ul style="list-style-type: none"> • ½" (13 mm) male NPT/Sweat inlets/outlets accept ½" copper, ½" iron pipe, PEX or CPVC adapters • Cast DZR brass valve body • Flow rate: 5.1 gpm @ 45 psi* • Back-to-back capability • Includes flush plug with stainless steel ring • Includes screwdriver stops for easy servicing at the valve • For use with TU series pressure balance bath/shower trim kits 	RU101SS	No Finish	103	
		<p>Flash® Shower Rough-In Valve With Stub-Outs</p> <ul style="list-style-type: none"> • ½" (13 mm) Stub-out inlets/outlets accept ½" press-connect fittings • Cast DZR brass valve body • Flow rate: 5.1 gpm @ 45 psi* • Back-to-back capability • Includes flush plug with stainless steel ring • Cartridge ships with trim • For use with TU series pressure balance bath/shower trim kits 	RU102	No Finish	72
		<p>Flash® Shower Rough-In Valve With Stub-Outs With Screwdriver Stops</p> <ul style="list-style-type: none"> • ½" (13 mm) Stub-out inlets/outlets accept ½" press-connect fittings • Cast DZR brass valve body • Flow rate: 5.1 gpm @ 45 psi* • Back-to-back capability • Includes flush plug with stainless steel ring • Includes screwdriver stops for easy servicing at the valve • Cartridge ships with trim • For use with TU series pressure balance bath/shower trim kits 	RU102SS	No Finish	103
		<p>Flash® Shower Rough-In Valve With PEX Inlets/Universal Outlets for Crimp Ring System</p> <ul style="list-style-type: none"> • ½" (3 mm) PEX crimp inlets/Universal outlets (ASTM F1807) • Cast DZR brass valve body • Flow rate: 5.1 gpm @ 45 psi* • Back-to-back capability • Includes flush plug with stainless steel ring • Cartridge ships with trim • For use with TU series pressure balance bath/shower trim kits 	RU107	No Finish	72
	<p>*When combined with Double Ceramic pressure balance cartridge.</p>	<p>List Price Guide 2023-4</p>	<p>americanstandard.com</p>		

	Description	SKU #	Color/Finish	List Price
	<p>Flash® Shower Rough-In Valve With PEX Inlets/Universal Outlets With Screwdriver Stops for Crimp Ring System</p> <ul style="list-style-type: none"> • ½" (13 mm) PEX crimp inlets/Universal outlets (ASTM F1807) • Cast DZR brass valve body • Flow rate: 5.1 gpm @ 45 psi* • Back-to-back capability • Includes flush plug with stainless steel ring • Includes screwdriver stops for easy servicing at the valve • Cartridge ships with trim • For use with TU series pressure balance bath/shower trim kits 	RU107SS	No Finish	103 
	<p>Flash® Shower Rough-In Valve With PEX Inlet Elbows/Universal Outlets for Crimp Ring System</p> <ul style="list-style-type: none"> • ½" (13 mm) PEX crimp elbow inlets/Universal outlets (ASTM F1807) • Cast DZR brass valve body • Flow rate: 5.1 gpm @ 45 psi* • Back-to-back capability • Includes flush plug with stainless steel ring • Cartridge ships with trim • For use with TU series pressure balance bath/shower trim kits 	RU107E	No Finish	95 
	<p>Flash® Shower Rough-In Valve With PEX Inlet Elbows/Universal Outlets With Screwdriver Stops for Crimp Ring System</p> <ul style="list-style-type: none"> • ½" (13 mm) PEX crimp elbow inlets/Universal outlets (ASTM F1807) • Cast DZR brass valve body • Flow rate: 5.1 gpm @ 45 psi* • Back-to-back capability • Includes flush plug with stainless steel ring • Includes screwdriver stops for easy servicing at the valve • Cartridge ships with trim • For use with TU series pressure balance bath/shower trim kits 	RU107ESS	No Finish	125 
	<p>Flash® Shower Rough-In Valve With PEX Inlets/Universal Outlets for Cold Expansion System</p> <ul style="list-style-type: none"> • ½" (13 mm) PEX cold expansion inlets/Universal outlets (ASTM F1960) • Cast DZR brass valve body • Flow rate: 5.1 gpm @ 45 psi* • Back-to-back capability • Includes flush plug with stainless steel ring • Cartridge ships with trim • For use with TU series pressure balance bath/shower trim kits 	RU108	No Finish	72 
	<p>Flash® Shower Rough-In Valve With PEX Inlets/Universal Outlets With Screwdriver Stops for Cold Expansion System</p> <ul style="list-style-type: none"> • ½" (13 mm) PEX cold expansion inlets/Universal outlets (ASTM F1960) • Cast DZR brass valve body • Flow rate: 5.1 gpm @ 45 psi* • Back-to-back capability • Includes flush plug with stainless steel ring • Includes screwdriver stops for easy servicing at the valve • For use with TU series pressure balance bath/shower trim kits 	RU108SS	No Finish	103 

















*When combined with Double Ceramic pressure balance cartridge.

	Description	SKU #	Color/Finish	List Price
	<p>Flash® Shower Rough-In Valve With PEX Inlet Elbows/Universal Outlets for Cold Expansion System</p> <ul style="list-style-type: none"> • ½" (13 mm) PEX cold expansion elbow inlets/ Universal outlets (ASTM F1960) • Cast DZR brass valve body • Flow rate: 5.1 gpm @ 45 psi* • Back-to-back capability • Includes flush plug with stainless steel ring • Cartridge ships with trim • For use with TU series pressure balance bath/ shower trim kits 	RU108E	No Finish	95 
	<p>Flash® Shower Rough-In Valve With PRX Inlet Elbows/Universal Outlets With Screwdriver Stops for Cold Expansion System</p> <ul style="list-style-type: none"> • ½" (13 mm) PEX cold expansion elbow inlets/ Universal outlets (ASTM F1960) • Cast DZR brass valve body • Flow rate: 5.1 gpm @ 45 psi* • Back-to-back capability • Includes flush plug with stainless steel ring • Includes screwdriver stops for easy servicing at the valve • Cartridge ships with trim • For use with TU series pressure balance bath/ shower trim kits 	RU108ESS	No Finish	125 
	<p>Flash® Shower Rough-In Valve With CPVC Inlets/Universal Outlets</p> <ul style="list-style-type: none"> • ½" (13 mm) CPVC inlets/Universal outlets • Cast DZR brass valve body • Flow rate: 5.1 gpm @ 45 psi* • Back-to-back capability • Includes flush plug with stainless steel ring • Cartridge ships with trim • For use with TU series pressure balance bath/ shower trim kits 	RU109	No Finish	95 
	<p>Flash® Shower Rough-In Valve With CPVC Inlets/Universal Outlets With Screwdriver Stops</p> <ul style="list-style-type: none"> • ½" (13 mm) CPVC inlets/Universal outlets • Cast DZR brass valve body • Flow rate: 5.1 gpm @ 45 psi* • Back-to-back capability • Includes flush plug with stainless steel ring • Includes screwdriver stops for easy servicing at the valve • Cartridge ships with trim • For use with TU series pressure balance bath/ shower trim kits 	RU109SS	No Finish	125 

*When combined with Double Ceramic pressure balance cartridge.

	Description	SKU #	Color/Finish	List Price
	Studio® S 2-Handle Integrated Shower Diverter Trim Only <ul style="list-style-type: none"> • Metal wall escutcheon • Metal lever handles • Works with Flash® 2-Way Integrated Shower Diverter Rough-In Valve with Pressure Balance Valve Cartridge, required and sold separately • Flash® 2-Way Integrated Shower Diverter Rough-In Valve RU521 ships with a 2-way Discrete cartridge • 2-Way Shared capability requires Flash® 2-Way Integrated Shower Diverter Rough-In Valve RU521, plus a 2-Way Shared pressure balance cartridge #M970720-0070A, sold separately • Flash® 3-Way Integrated Shower Diverter Rough-In Valve RU531 ships with a 3-Way Discrete cartridge • 3-Way Shared capability requires Flash® 3-Way Integrated Shower Diverter Rough-In Valve RU531, plus a 3-Way Shared pressure balance cartridge #M970730-0070A, sold separately • 3-way diverter with shared flow requires cartridge M970730-0070A (sold separately) 	ADA TU105740.002	Polished Chrome	261
		TU105740.243	Matte Black	392
		TU105740.295	Brushed Nickel	364
				
	Flash® 2-Way Integrated Shower Diverter Rough-In Valve with Pressure Balance Valve Cartridge <ul style="list-style-type: none"> • Made of casted DZR brass to resist corrosion • For use with Flash® 2-Handle Integrated Shower Diverter Trim • ½" NPT Inlets/Outlets • Valve ships with a 2-Way Discrete pressure balance cartridge • 2-Way Shared functionality requires RU521 valve, plus purchase of 2-Way Shared cartridge RP# M970720-0070A, sold separately • Compatible with Delancey®, Serin®, Studio® S, Town Square® S, Times Square® and Townsend® trims • Trim sold separately 	RU521	No Finish	355
				
	Flash® 2-Way Shared Diverter Cartridge <ul style="list-style-type: none"> • For use with RU521 valve 	M970720-0070A	No Finish	79
	Flash® 3-Way Integrated Shower Diverter Rough-In Valve with Pressure Balance Valve Cartridge <ul style="list-style-type: none"> • Made of casted DZR brass to resist corrosion • For use with Flash® 2-Handle Integrated Shower Diverter Trim • ½" NPT Inlets/Outlets • Valve ships with a 3-Way Discrete pressure balance cartridge • 3-Way Shared functionality requires RU531 valve, plus purchase of 3-Way Shared cartridge RP# M970730-0070A, sold separately • Compatible with Delancey®, Serin®, Studio® S, Town Square® S, Times Square® and Townsend® trims • Trim sold separately 	RU531	No Finish	385
				
	Flash® 3-Way Shared Diverter Cartridge <ul style="list-style-type: none"> • For use with RU531 valve 	M970730-0070A	No Finish	79

Studio S

	Description	SKU #	Color/Finish	List Price
	Studio® S Single-Handle Diverter Valve Trim Kit	 T105430.002	Polished Chrome	119
	<ul style="list-style-type: none"> • Metal lever handle • Removable plaster guard • Valve sold separately 	T105430.243	Matte Black	180
		T105430.295	Brushed Nickel	165
		  		
	2-Way In-Wall Diverter Rough-In Valve With 2 Discrete Functions	R422	No Finish	231
	<ul style="list-style-type: none"> • Durable cast brass valve body – excellent for high use applications with prolonged water use • Controls water flow between 2 outlets (shower or sprays) • ½" (13 mm) NPT inlets/outlets • Trim must be ordered separately 	 		
	2-Way In-Wall Diverter Rough-In Valve With 2 Discrete/1 Shared Function	R422S	No Finish	231
	<ul style="list-style-type: none"> • Durable cast brass valve body – excellent for high use applications with prolonged water use • Controls water flow between 2 outlets (shower or sprays) • ½" (13 mm) NPT inlets/outlets • Trim must be ordered separately 	 		
	3-Way In-Wall Diverter Rough-In Valve With 3 Discrete Functions	R433	No Finish	262
	<ul style="list-style-type: none"> • Durable cast brass valve body – excellent for high use applications with prolonged water use • Controls water flow between 3 outlets (shower or sprays) • ½" (13 mm) NPT inlets/outlets • Trim must be ordered separately 	 		
	3-Way In-Wall Diverter Rough-In Valve With 3 Discrete/3 Shared Functions	R433S	No Finish	262
	<ul style="list-style-type: none"> • Durable cast brass valve body – excellent for high use applications with prolonged water use • Controls water flow between 3 outlets (shower or sprays) • ½" (13 mm) NPT inlets/outlets • Trim must be ordered separately 	 		

Studio S

Studio S Flash® Pressure Balance Bath/Shower System

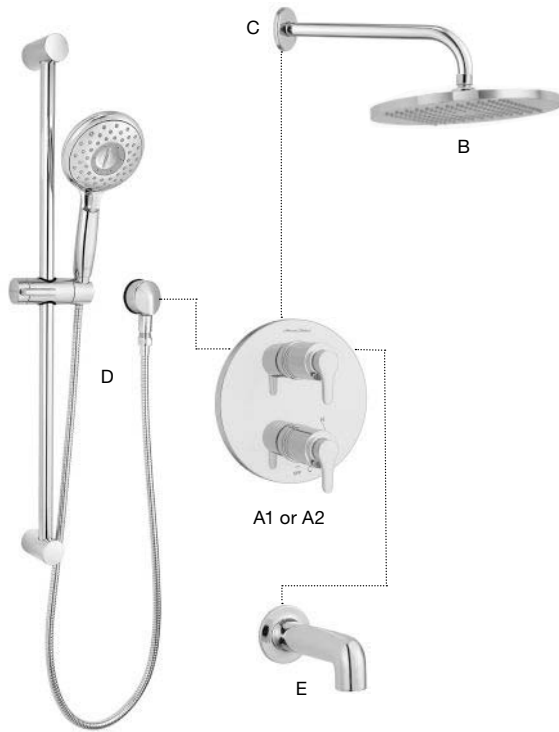

Studio S Flash Pressure Balance Shower System

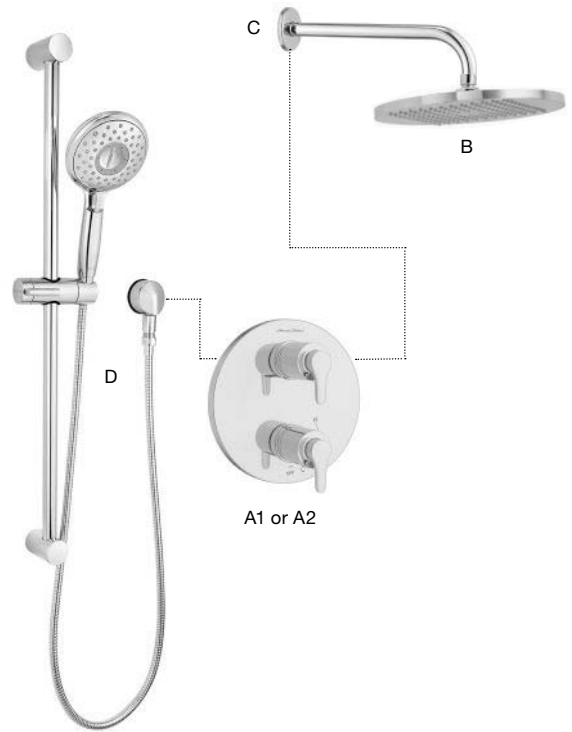

Studio S Pressure Balance Bath/Shower System

DESCRIPTION	QTY	SKU #	LIST PRICE FOR SYSTEM	
			002	295
A Studio S Flash 2-Handle Integrated Shower Diverter Trim	1	TU105740	261	364
B 10" Modern Rain Showerhead	1	1660683	296	443
C 12" Wall-Mount Right Angle Shower Arm	1	1660194	101	152
D Spectra Handheld® Slide Bar Kit	1	1660774	247	334
E Studio S Tub Spout	1	8888316	93	130

Required Components – Choose From Rough-In Valve 1 or 2 (not shown)





1	3-Way Discrete (Non-Shared) Functionality – Requires Flash 3-Way Integrated Shower Diverter Rough-In Valve with Pressure Balance Valve Cartridge	1	RU531	385	
2	3-Way (Shared) Functionality – Requires Flash 3-Way Integrated Shower Diverter Rough-In Valve with Pressure Balance Valve Cartridge, also requires 3-way shared function cartridge M970730-0070A (sold separately)	1	RU531 + M970730-0070A	385 + 79 = 464	
3-Way Discrete (Non-Shared) Bath/Shower System Total				1,383	1,808
3-Way (Shared) Bath/Shower System Total				1,462	1,887

Studio S Pressure Balance Shower System

DESCRIPTION	QTY	SKU #	LIST PRICE FOR SYSTEM	
			002	295
A Studio S Flash 2-Handle Integrated Shower Diverter Trim	1	TU105740	261	364
B 10" Modern Rain Showerhead	1	1660683	296	443
C 12" Wall-Mount Right Angle Shower Arm	1	1660194	101	152
D Spectra Handheld Slide Bar Kit	1	1660774	247	334

Required Components – Choose From Rough-In Valve 1 or 2 (not shown)

1	2-Way Discrete (Non-Shared) Functionality – Requires Flash 2-Way Integrated Shower Diverter Rough-In Valve with Pressure Balance Valve Cartridge	1	RU521	355	
2	2-Way (Shared) Functionality – Requires Flash 2-Way Integrated Shower Diverter Rough-In Valve with Pressure Balance Valve Cartridge, also requires 2-way shared function cartridge M970720-0070A (sold separately)	1	RU521 + M970720-0070A	355 + 79 = 434	
2-Way Discrete (Non-Shared) Bath/Shower System Total				1,260	1,648
2-Way (Shared) Bath/Shower System Total				1,339	1,727

	Description	SKU #	Color/Finish	List Price
	Studio® S 18-Inch Towel Bar	7105018.002	Polished Chrome	65
	• Brass bar	7105018.243	Matte Black	100
	• All metal construction	7105018.295	Brushed Nickel	90
	• Concealed mounting: no exposed set screws • Coordinates with Studio® S bath faucet collection • Limited lifetime warranty on function and finish			 
	Studio® S 24-Inch Towel Bar	7105024.002	Polished Chrome	68
	• Brass bar	7105024.243	Matte Black	106
	• All metal construction	7105024.295	Brushed Nickel	96
	• Concealed mounting: no exposed set screws • Coordinates with Studio® S bath faucet collection • Limited lifetime warranty on function and finish			 
	Studio® S Towel Ring	7105190.002	Polished Chrome	41
	• Coordinates with Studio® S bath faucet collection	7105190.243	Matte Black	63
	• Concealed mounting with no exposed screws for a seamless appearance	7105190.295	Brushed Nickel	57
	• Easy to install • Limited lifetime warranty on function and finish			 
	Studio® S Double Robe Hook	7105210.002	Polished Chrome	31
	• Solid metal construction is durable and long-lasting	7105210.243	Matte Black	47
	• Concealed mounting: no exposed set screws	7105210.295	Brushed Nickel	43
	• Coordinates with Studio® S bath faucet collection • Easy to install • Limited lifetime warranty on function and finish			 
	Studio® S 24-Inch Double Towel Bar	7105224.002	Polished Chrome	137
	• Brass bar	7105224.243	Matte Black	205
	• All metal construction	7105224.295	Brushed Nickel	192
	• Concealed mounting: no exposed set screws • Coordinates with Studio® S bath faucet collection • Limited lifetime warranty on function and finish			 
	Studio® S Toilet Paper Holder	7105230.002	Polished Chrome	52
	• All metal construction	7105230.243	Matte Black	82
	• Concealed mounting: no exposed set screws	7105230.295	Brushed Nickel	74
	• Coordinates with Studio® S bath faucet collection • Easy to install • Limited lifetime warranty on function and finish			 



Studio S

Add an element of design drama to your bathroom with the **Town Square S Collection**. Rich, architectural lines reflect traditional elegance, superior craftsmanship, and lasting beauty.



Town Square S

Sink



Widespread Faucet
7455807801



Monoblock Faucet
7455107



Centerset Faucet
7455207



Wall Mount Faucet
7455451

Bath



Bathtub Faucets
T455900, T455901



Freestanding Bathtub Faucet
T455951

Shower



Bath/Shower Trim Kits
TU455502, TU455508



2-Handle Integrated
Shower Diverter Trim Kit
TU455740



Diverter Valve Trim Kit
T455430



Fixed Showerhead
1660516

Accessories



Town Square S
18" Towel Bar
7455018



Town Square S
24" Towel Bar
7455024



Town Square S
Towel Ring
7455190



Town Square S
Toilet Paper Holder
7455230



Town Square S
Double Robe Hook
7455210









Town Square S

Town Square® S







Sink and Bath Faucets

	Description	SKU #	Color/Finish	List Price
	Town Square® S 8-Inch Widespread 2-Handle Bathroom Faucet 1.2 gpm/4.5 L/min With Lever Handles <ul style="list-style-type: none"> • Brass construction and washerless ceramic disc valve cartridges • Water-conserving 1.2 gpm/4.5 L/min pressure-compensating aerator • Valve bodies with integrated flexible hose connections for 6"-12" (152-305 mm) installations • Metal lever handles • Brass pop-up drain • Cast Brass Spout 	7455801.002	Polished Chrome	496
		7455801.013	Polished Nickel	695
		7455801.278	Legacy Bronze	744
		7455801.295	Brushed Nickel	695
	Town Square® S Single Hole Single-Handle Bathroom Faucet 1.2 gpm/4.5 L/min With Lever Handle <ul style="list-style-type: none"> • Brass construction and washerless ceramic disc valve cartridge • Water-conserving 1.2 gpm/4.5 L/min pressure-compensating aerator • Braided flexible hoses with 3/8" (10 mm) compression connections • Metal lever handle • Brass push pop drain 	7455107.002	Polished Chrome	341
		7455107.013	Polished Nickel	478
		7455107.278	Legacy Bronze	516
		7455107.295	Brushed Nickel	478
	Town Square® S 4-Inch Centerset 2-Handle Bathroom Faucet 1.2 gpm/4.5 L/min With Lever Handles <ul style="list-style-type: none"> • Brass construction and washerless ceramic disc valve cartridges • Water-conserving 1.2 gpm/4.5 L/min pressure-compensating aerator • 1/2" (13 mm) male pipe inlets • Metal lever handles • Brass push pop-up drain 	7455207.002	Polished Chrome	311
		7455207.013	Polished Nickel	435
		7455207.278	Legacy Bronze	465
		7455207.295	Brushed Nickel	435
	Town Square® S 2-Handle Wall Mount Faucet 1.2 gpm/4.5 L/min With Lever Handles <ul style="list-style-type: none"> • Brass construction and washerless ceramic disc valve cartridges • Water-conserving 1.2 gpm/4.5 L/min pressure-compensating aerator • Braided flexible hoses with 3/8" (10 mm) compression connections • Metal lever handles • Grid drain 	7455451.002	Polished Chrome	496
		7455451.013	Polished Nickel	695
		7455451.278	Legacy Bronze	744
		7455451.295	Brushed Nickel	695

Town Square S







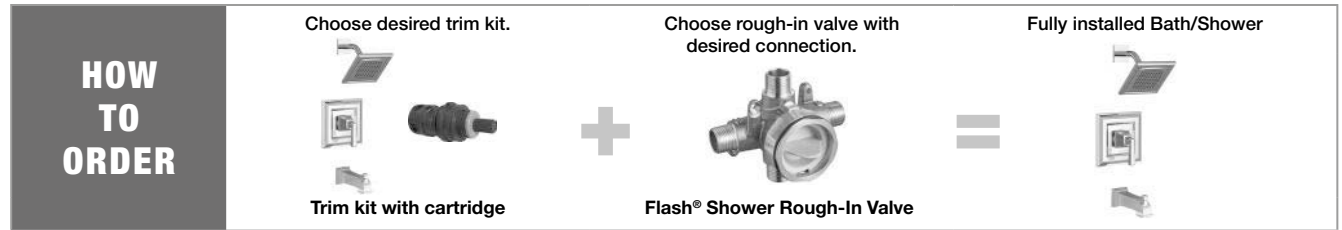

	Description	SKU #	Color/Finish	List Price
	<p>Town Square® S Bath Tub Faucet With Lever Handles and Personal Shower for Flash® Rough-in Valve</p> <ul style="list-style-type: none"> • Brass construction • All personal showers feature 5' (152 cm) long hose • Metal lever handles • Personal shower features 1.8 gpm/6.8 L/min maximum flow • For use with Flash® bathtub faucet rough-in valve R910 • Valve sold separately 	<p>CEC</p> <p>T455901.002</p>	Polished Chrome	868
		T455901.013	Polished Nickel	1,215
		T455901.278	Legacy Bronze	1,302
		T455901.295	Brushed Nickel	1,215
				
	<p>Town Square® S Bath Tub Faucet With Lever Handles for Flash® Rough-In Valve</p> <ul style="list-style-type: none"> • Brass construction • Metal lever handles • Less personal shower • For use with Flash® bathtub faucet rough-in valve R900 • Valve sold separately 	<p>ADA</p> <p>T455900.002</p>	Polished Chrome	621
		T455900.013	Polished Nickel	868
		T455900.278	Legacy Bronze	931
		T455900.295	Brushed Nickel	868
				
	<p>Flash® Bathtub Filler Rough-In Valve With Personal Shower</p> <ul style="list-style-type: none"> • Brass construction and washerless ¼-turn ceramic disc valves cartridge • ½" (13 mm) copper inlets • Connections to spout can be made via flexible hoses (provided) or ½" (13 mm) copper sweat connections • 14 gpm/59.2 L/min maximum flow rate at 40 psi • 8"-16" (203-406 mm) flexible installation • Adjustable rough-in: 2-½" (64 mm) maximum deck thickness • Includes hand shower rough-in 	R910	No Finish	322
				
	<p>Flash® Bathtub Filler Rough-In Valve</p> <ul style="list-style-type: none"> • Brass construction and washerless ¼-turn ceramic disc valve cartridges • ½" (13 mm) copper inlets • Connections to spout can be made via flexible hoses (provided) or ½" (13 mm) copper sweat connections • 14 gpm/52.9 L/min maximum flow rate at 40 psi • 8"-16" (203-406 mm) flexible installation • Adjustable rough-in: 2-½" (64 mm) maximum deck thickness 	R900	No Finish	184
				

Town Square S

















	Description	SKU #	Color/Finish	List Price
	Town Square® S Freestanding Bathtub Faucet With Lever Handle for Flash® Rough-In Valve	 T455951.002	Polished Chrome	1,384
		T455951.013	Polished Nickel	1,938
	<ul style="list-style-type: none"> • Brass construction and ¼-turn washerless ceramic disc valve cartridge 	T455951.278	Legacy Bronze	2,074
	<ul style="list-style-type: none"> • Personal shower features 59" (1499 mm) long hose with 1.8 gpm/6.8 L/min maximum flow • Metal lever handle • Overall height: 43-½" (1105 mm) • Spout reach: 8-½" (218 mm) • Metal hand shower • Shower bracket pivots 60° • For use with Flash® freestanding tub faucet rough-in valve (sold separately) 	T455951.295	Brushed Nickel	1,938
				
	Flash® Freestanding Bathtub Filler Rough-In Valve	R950	No Finish	230
<ul style="list-style-type: none"> • Brass construction • ½" (13 mm) copper inlets • Level adjustable • Test plugs included • Must order trim separately 				
				
	Flash® Freestanding Bathtub Filler Rough-In Valve With Screwdriver Stops	R950SS	No Finish	265
<ul style="list-style-type: none"> • Brass construction • ½" (13 mm) copper inlets • Level adjustable • Test plugs included • Must order trim separately • Includes screwdriver stops for easy servicing at the valve 				
				





Town Square S



	Description	SKU #	Color/Finish	List Price
	<p>Town Square® S 2.5 gpm/9.5 L/min Tub and Shower Trim Kit With Single Function Showerhead, Double Ceramic Pressure Balance Cartridge With Lever Handle</p> <ul style="list-style-type: none"> • Includes Double Ceramic pressure balance cartridge • 6-¼" (160 mm) single function showerhead 2.5 gpm/9.5 L/min maximum flow • Brass shower arm • Metal wall escutcheon • Metal lever handle • Metal slip-on diverter tub spout • For use with Flash® shower rough-in valves, sold separately 	TU455502.002	Polished Chrome	477
		TU455502.013	Polished Nickel	654
		TU455502.278	Legacy Bronze	701
		TU455502.295	Brushed Nickel	654
				
	<p>Town Square® S 2.5 gpm/9.5 L/min Shower Trim Kit With Single Function Showerhead, Double Ceramic Pressure Balance Cartridge With Lever Handle</p> <ul style="list-style-type: none"> • Includes Double Ceramic pressure balance cartridge • 6-¼" (160 mm) single function showerhead 2.5 gpm/9.5 L/min maximum flow • Brass shower arm • Metal wall escutcheon • Metal lever handle • For use with Flash® shower rough-in valves, sold separately 	 TU455501.002	Polished Chrome	384
		TU455501.013	Polished Nickel	525
		TU455501.278	Legacy Bronze	561
		TU455501.295	Brushed Nickel	525
				
	<p>Town Square® S Valve Only Trim Kit With Double Ceramic Pressure Balance Cartridge With Lever Handle</p> <ul style="list-style-type: none"> • Includes Double Ceramic pressure balance cartridge • Metal wall escutcheon • Metal lever handle • For use with Flash® shower rough-in valves, sold separately 	 TU455500.002	Polished Chrome	267
		TU455500.013	Polished Nickel	360
		TU455500.278	Legacy Bronze	384
		TU455500.295	Brushed Nickel	360
				

Town Square S



	Description	SKU #	Color/Finish	List Price
   	<p>Town Square® S 1.75 gpm/6.8 L/min Tub and Shower Trim Kit With Water-Saving Showerhead, Double Ceramic Pressure Balance Cartridge With Lever Handle</p> <ul style="list-style-type: none"> • Includes Double Ceramic pressure balance cartridge • Water-saving 6-1/4" (160 mm) single function showerhead, 1.8 gpm/6.8 L/min maximum flow • Brass shower arm • Metal wall escutcheon • Metal lever handle • Metal slip-on diverter tub spout • For use with Flash® shower rough-in valves, sold separately 	 <p>TU455508.002 TU455508.013 TU455508.278 TU455508.295</p>	<p>Polished Chrome Polished Nickel Legacy Bronze Brushed Nickel</p>	<p>477 654 701 654</p>   
  	<p>Town Square® S 1.75 gpm/6.8 L/min Shower Trim Kit With Water-Saving Showerhead, Double Ceramic Pressure Balance Cartridge With Lever Handle</p> <ul style="list-style-type: none"> • Includes Double Ceramic pressure balance cartridge • Water-saving 6-1/4" (160 mm) single function showerhead, 1.8 gpm/6.8 L/min maximum flow • Brass shower arm • Metal wall escutcheon • Metal lever handle • For use with Flash® shower rough-in valves, sold separately 	  <p>TU455507.002 TU455507.013 TU455507.278 TU455507.295</p>	<p>Polished Chrome Polished Nickel Legacy Bronze Brushed Nickel</p>	<p>384 525 561 525</p>   

	Description	SKU #	Color/Finish	List Price
	<p>Flash® Shower Rough-In Valve With Universal Inlets/Outlets</p> <ul style="list-style-type: none"> • ½" (13 mm) male NPT/Sweat inlets/outlets accept ½" copper, ½" iron pipe, PEX or CPVC adapters • Cast DZR brass valve body • Flow rate: 5.1 gpm @ 45 psi* • Back-to-back capability • Includes flush plug with stainless steel ring • Cartridge ships with trim • For use with TU series pressure balance bath/shower trim kits 	RU101	No Finish	72
	<p>Flash® Shower Rough-In Valve With Universal Inlets/Outlets With Screwdriver Stops</p> <ul style="list-style-type: none"> • ½" (13 mm) male NPT/Sweat inlets/outlets accept ½" copper, ½" iron pipe, PEX or CPVC adapters • Cast DZR brass valve body • Flow rate: 5.1 gpm @ 45 psi* • Back-to-back capability • Includes flush plug with stainless steel ring • Includes screwdriver stops for easy servicing at the valve • For use with TU series pressure balance bath/shower trim kits 	RU101SS	No Finish	103
	<p>Flash® Shower Rough-In Valve With Stub-Outs</p> <ul style="list-style-type: none"> • ½" (13 mm) Stub-out inlets/outlets accept ½" press-connect fittings • Cast DZR brass valve body • Flow rate: 5.1 gpm @ 45 psi* • Back-to-back capability • Includes flush plug with stainless steel ring • Cartridge ships with trim • For use with TU series pressure balance bath/shower trim kits 	RU102	No Finish	72
	<p>Flash® Shower Rough-In Valve With Stub-Outs With Screwdriver Stops</p> <ul style="list-style-type: none"> • ½" (13 mm) Stub-out inlets/outlets accept ½" press-connect fittings • Cast DZR brass valve body • Flow rate: 5.1 gpm @ 45 psi* • Back-to-back capability • Includes flush plug with stainless steel ring • Includes screwdriver stops for easy servicing at the valve • Cartridge ships with trim • For use with TU series pressure balance bath/shower trim kits 	RU102SS	No Finish	103
	<p>Flash® Shower Rough-In Valve With PEX Inlets/Universal Outlets for Crimp Ring System</p> <ul style="list-style-type: none"> • ½" (3 mm) PEX crimp inlets/Universal outlets (ASTM F1807) • Cast DZR brass valve body • Flow rate: 5.1 gpm @ 45 psi* • Back-to-back capability • Includes flush plug with stainless steel ring • Cartridge ships with trim • For use with TU series pressure balance bath/shower trim kits 	RU107	No Finish	72



Town Square S



*When combined with Double Ceramic pressure balance cartridge.

















	Description	SKU #	Color/Finish	List Price
	<p>Flash® Shower Rough-In Valve With PEX Inlets/Universal Outlets With Screwdriver Stops for Crimp Ring System</p> <ul style="list-style-type: none"> • ½" (13 mm) PEX crimp inlets/Universal outlets (ASTM F1807) • Cast DZR brass valve body • Flow rate: 5.1 gpm @ 45 psi* • Back-to-back capability • Includes flush plug with stainless steel ring • Includes screwdriver stops for easy servicing at the valve • Cartridge ships with trim • For use with TU series pressure balance bath/shower trim kits 	RU107SS	No Finish	103
	<p>Flash® Shower Rough-In Valve With PEX Inlet Elbows/Universal Outlets for Crimp Ring System</p> <ul style="list-style-type: none"> • ½" (13 mm) PEX crimp elbow inlets/Universal outlets (ASTM F1807) • Cast DZR brass valve body • Flow rate: 5.1 gpm @ 45 psi* • Back-to-back capability • Includes flush plug with stainless steel ring • Cartridge ships with trim • For use with TU series pressure balance bath/shower trim kits 	RU107E	No Finish	95
	<p>Flash® Shower Rough-In Valve With PEX Inlet Elbows/Universal Outlets With Screwdriver Stops for Crimp Ring System</p> <ul style="list-style-type: none"> • ½" (13 mm) PEX crimp elbow inlets/Universal outlets (ASTM F1807) • Cast DZR brass valve body • Flow rate: 5.1 gpm @ 45 psi* • Back-to-back capability • Includes flush plug with stainless steel ring • Includes screwdriver stops for easy servicing at the valve • Cartridge ships with trim • For use with TU series pressure balance bath/shower trim kits 	RU107ESS	No Finish	125
	<p>Flash® Shower Rough-In Valve With PEX Inlets/Universal Outlets for Cold Expansion System</p> <ul style="list-style-type: none"> • ½" (13 mm) PEX cold expansion inlets/Universal outlets (ASTM F1960) • Cast DZR brass valve body • Flow rate: 5.1 gpm @ 45 psi* • Back-to-back capability • Includes flush plug with stainless steel ring • Cartridge ships with trim • For use with TU series pressure balance bath/shower trim kits 	RU108	No Finish	72
	<p>Flash® Shower Rough-In Valve With PEX Inlets/Universal Outlets With Screwdriver Stops for Cold Expansion System</p> <ul style="list-style-type: none"> • ½" (13 mm) PEX cold expansion inlets/Universal outlets (ASTM F1960) • Cast DZR brass valve body • Flow rate: 5.1 gpm @ 45 psi* • Back-to-back capability • Includes flush plug with stainless steel ring • Includes screwdriver stops for easy servicing at the valve • For use with TU series pressure balance bath/shower trim kits 	RU108SS	No Finish	103

*When combined with Double Ceramic pressure balance cartridge.

	Description	SKU #	Color/Finish	List Price
	<p>Flash® Shower Rough-In Valve With PEX Inlet Elbows/Universal Outlets for Cold Expansion System</p> <ul style="list-style-type: none"> • ½" (13 mm) PEX cold expansion elbow inlets/ Universal outlets (ASTM F1960) • Cast DZR brass valve body • Flow rate: 5.1 gpm @ 45 psi* • Back-to-back capability • Includes flush plug with stainless steel ring • Cartridge ships with trim • For use with TU series pressure balance bath/ shower trim kits 	RU108E	No Finish	95 
	<p>Flash® Shower Rough-In Valve With PRX Inlet Elbows/Universal Outlets With Screwdriver Stops for Cold Expansion System</p> <ul style="list-style-type: none"> • ½" (13 mm) PEX cold expansion elbow inlets/ Universal outlets (ASTM F1960) • Cast DZR brass valve body • Flow rate: 5.1 gpm @ 45 psi* • Back-to-back capability • Includes flush plug with stainless steel ring • Includes screwdriver stops for easy servicing at the valve • Cartridge ships with trim • For use with TU series pressure balance bath/ shower trim kits 	RU108ESS	No Finish	125 
	<p>Flash® Shower Rough-In Valve With CPVC Inlets/Universal Outlets</p> <ul style="list-style-type: none"> • ½" (13 mm) CPVC inlets/Universal outlets • Cast DZR brass valve body • Flow rate: 5.1 gpm @ 45 psi* • Back-to-back capability • Includes flush plug with stainless steel ring • Cartridge ships with trim • For use with TU series pressure balance bath/ shower trim kits 	RU109	No Finish	95 
	<p>Flash® Shower Rough-In Valve With CPVC Inlets/Universal Outlets With Screwdriver Stops</p> <ul style="list-style-type: none"> • ½" (13 mm) CPVC inlets/Universal outlets • Cast DZR brass valve body • Flow rate: 5.1 gpm @ 45 psi* • Back-to-back capability • Includes flush plug with stainless steel ring • Includes screwdriver stops for easy servicing at the valve • Cartridge ships with trim • For use with TU series pressure balance bath/ shower trim kits 	RU109SS	No Finish	125 















*When combined with Double Ceramic pressure balance cartridge.

	Description	SKU #	Color/Finish	List Price	
	Town Square® S 2-Handle Integrated Shower Diverter Trim Only		TU455740.002 Polished Chrome	271	
			TU455740.013 Polished Nickel	379	
			TU455740.278 Legacy Bronze	404	
			TU455740.295 Brushed Nickel	379	
	<ul style="list-style-type: none"> • Metal wall escutcheon • Metal lever handles • Works with Flash® 2-Way Integrated Shower Diverter Rough-In Valve with Pressure Balance Valve Cartridge, required and sold separately • Flash® 2-Way Integrated Shower Diverter Rough-In Valve RU521 ships with a 2-way Discrete cartridge • 2-Way Shared capability requires Flash® 2-Way Integrated Shower Diverter Rough-In Valve RU521, plus a 2-Way Shared pressure balance cartridge #M970720-0070A, sold separately • Flash® 3-Way Integrated Shower Diverter Rough-In Valve RU531 ships with a 3-Way Discrete cartridge • 3-Way Shared capability requires Flash® 3-Way Integrated Shower Diverter Rough-In Valve RU531, plus a 3-Way Shared pressure balance cartridge #M970730-0070A, sold separately • 3-way diverter with shared flow requires cartridge M970730-0070A (sold separately) 				
	Flash® 2-Way Integrated Shower Diverter Rough-In Valve with Pressure Balance Valve Cartridge	RU521		No Finish	355
	<ul style="list-style-type: none"> • Made of casted DZR brass to resist corrosion • For use with Flash® 2-Handle Integrated Shower Diverter Trim • ½" NPT Inlets/Outlets • Valve ships with a 2-Way Discrete pressure balance cartridge • 2-Way Shared functionality requires RU521 valve, plus purchase of 2-Way Shared cartridge RP# M970720-0070A, sold separately • Compatible with Delancey®, Serin®, Studio® S, Town Square® S, Times Square® and Townsend® trims • Trim sold separately 				
	Flash® 2-Way Shared Diverter Cartridge			M970720-0070A	No Finish
	<ul style="list-style-type: none"> • For use with RU521 valve 				
	Flash® 3-Way Integrated Shower Diverter Rough-In Valve with Pressure Balance Valve Cartridge		RU531	No Finish	385
	<ul style="list-style-type: none"> • Made of casted DZR brass to resist corrosion • For use with Flash® 2-Handle Integrated Shower Diverter Trim • ½" NPT Inlets/Outlets • Valve ships with a 3-Way Discrete pressure balance cartridge • 3-Way Shared functionality requires RU531 valve, plus purchase of 3-Way Shared cartridge RP# M970730-0070A, sold separately • Compatible with Delancey®, Serin®, Studio® S, Town Square® S, Times Square® and Townsend® trims • Trim sold separately 				
	Flash® 3-Way Shared Diverter Cartridge		M970730-0070A	No Finish	79
	<ul style="list-style-type: none"> • For use with RU531 valve 				

	Description	SKU #	Color/Finish	List Price
	Town Square® S Single-Handle Diverter Valve Trim Kit	 T455430.002	Polished Chrome	125
	<ul style="list-style-type: none"> • Metal lever handle • Less valve 	T455430.013	Polished Nickel	175
	<ul style="list-style-type: none"> • Valve must be purchased separately 	T455430.278	Legacy Bronze	188
	<ul style="list-style-type: none"> • For use with rough-in valves R422, R422S, R433 and R433S 	T455430.295	Brushed Nickel	175
			  	
	2-Way In-Wall Diverter Rough-In Valve With 2 Discrete Functions	R422	No Finish	231
	<ul style="list-style-type: none"> • Durable cast brass valve body – excellent for high use applications with prolonged water use • Controls water flow between 2 outlets (shower or sprays) • ½" (13 mm) NPT inlets/outlets • Trim must be ordered separately 			 
	2-Way In-Wall Diverter Rough-In Valve With 2 Discrete/1 Shared Function	R422S	No Finish	231
	<ul style="list-style-type: none"> • Durable cast brass valve body – excellent for high use applications with prolonged water use • Controls water flow between 2 outlets (shower or sprays) • ½" (13 mm) NPT inlets/outlets • Trim must be ordered separately 			 
	3-Way In-Wall Diverter Rough-In Valve With 3 Discrete Functions	R433	No Finish	262
	<ul style="list-style-type: none"> • Durable cast brass valve body – excellent for high use applications with prolonged water use • Controls water flow between 3 outlets (shower or sprays) • ½" (13 mm) NPT inlets/outlets • Trim must be ordered separately 			 
	3-Way In-Wall Diverter Rough-In Valve With 3 Discrete/3 Shared Functions	R433S	No Finish	262
	<ul style="list-style-type: none"> • Durable cast brass valve body – excellent for high use applications with prolonged water use • Controls water flow between 3 outlets (shower or sprays) • ½" (13 mm) NPT inlets/outlets • Trim must be ordered separately 			 

Town Square® S

Accessories

	Description	SKU #	Color/Finish	List Price
	Town Square® S 18-Inch Towel Bar	7455018.002	Polished Chrome	70
	• Brass bar	7455018.013	Polished Nickel	96
	• All metal construction	7455018.278	Legacy Bronze	104
	• Concealed mounting: no exposed set screws	7455018.295	Brushed Nickel	96
	• Coordinates with Town Square® S bath faucet collection			
	• Limited lifetime warranty on function and finish			 
	Town Square® S 24-Inch Towel Bar	7455024.002	Polished Chrome	76
	• Brass bar	7455024.013	Polished Nickel	105
	• All metal construction	7455024.278	Legacy Bronze	112
	• Concealed mounting: no exposed set screws	7455024.295	Brushed Nickel	105
	• Coordinates with Town Square® S bath faucet collection			
	• Limited lifetime warranty on function and finish			 
	Town Square® S Towel Ring	7455190.002	Polished Chrome	45
	• Part of the coordinated Town Square S® collection	7455190.013	Polished Nickel	61
	• Concealed mounting with no exposed screws for a seamless appearance	7455190.278	Legacy Bronze	66
	• Bushing on towel ring to prevent scratching and squeaking	7455190.295	Brushed Nickel	61
	• Easy to install			
	• 7" (178 mm) diameter ring			 
	• Limited lifetime warranty on function and finish			
	Town Square® S Double Robe Hook	7455210.002	Polished Chrome	32
	• All metal construction	7455210.013	Polished Nickel	45
	• Concealed mounting: no exposed set screws	7455210.278	Legacy Bronze	45
	• Coordinates with Town Square S® bath faucet collection	7455210.295	Brushed Nickel	45
	• Easy to install			
	• Limited lifetime warranty on function and finish			 
	• Solid metal construction is durable and long-lasting			
	Town Square® S Toilet Paper Holder	7455230.002	Polished Chrome	57
	• All metal construction	7455230.013	Polished Nickel	80
	• Concealed mounting: no exposed set screws	7455230.278	Legacy Bronze	86
	• Coordinates with Town Square® S bath faucet collection	7455230.295	Brushed Nickel	80
	• Easy to install			
	• Limited lifetime warranty on function and finish			 
	Town Square® S 24-Inch Train Rack	7455260.002	Polished Chrome	496
	• 24" (600 mm) length	7455260.013	Polished Nickel	695
	• All metal construction	7455260.278	Legacy Bronze	744
	• Concealed mounting: no exposed set screws	7455260.295	Brushed Nickel	695
	• Coordinates with Town Square® S bath faucet collection			
	• Limited lifetime warranty on function and finish			 

Town Square S



Town Square S

Inspired by vintage industrial design, the **Townsend Collection** lends character to your bathroom, displaying a sense of hand-forged craftsmanship and unparalleled beauty.



Sink



Widespread Faucet
7353801



Widespread Faucet
7353841



Monoblock Faucet
7353101

Bath



Bathtub Faucets
T353901, T353900



Tub Spouts

Shower



Bath/Shower Trim Kits
TU353502



2-Handle Integrated
Shower Diverter Trim Kit
TU353740



Showerhead
1660509

Accessories



Townsend
18" Towel Bar
7353018



Townsend
24" Towel Bar
7353024



Townsend
Towel Ring
7353190











Townsend
Toilet Paper Holder
7353230







Townsend
Double Robe Hook
7353210

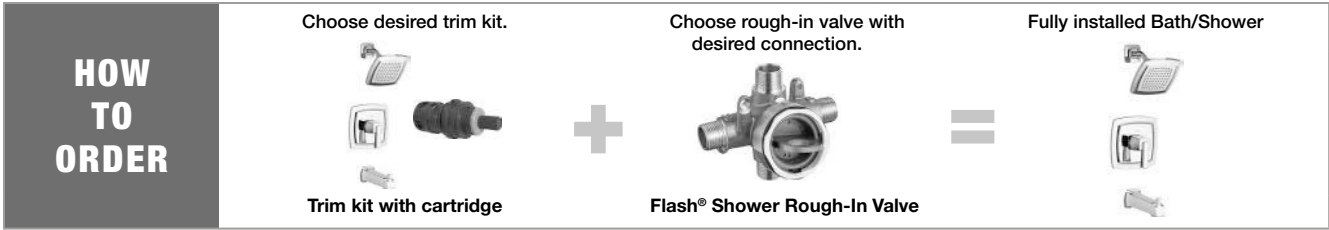







	Description	SKU #	Color/Finish	List Price
 <p>Townsend® 8-Inch Widespread 2-Handle Bathroom Faucet 1.2 gpm/4.5 L/min</p> <ul style="list-style-type: none"> • Brass construction • Washerless ceramic disc valve cartridges • Water-conserving 1.2 gpm/4.5 L/min pressure-compensating aerator • Cast brass spout • Cast brass valve bodies with reinforced flexible hose connections for 6" – 12" (152 – 305 mm) installations • Braided flexible supply hoses with 3/8" (10 mm) compression connectors • Metal lever handles • Brass push pop-up drain 		7353801.002	Polished Chrome	442
		7353801.013	Polished Nickel	615
		7353801.243	Matte Black	641
		7353801.278	Legacy Bronze	661
		7353801.295	Brushed Nickel	615
 <p>Townsend® 8-Inch Widespread 2-Handle Bathroom Faucet 1.2 gpm/4.5 L/min With Lever Handles</p> <ul style="list-style-type: none"> • Brass construction • Washerless ceramic disc valve cartridges • Water-conserving 1.2 gpm/4.5 L/min pressure-compensating aerator • Cast brass spout • Cast brass valve bodies with reinforced flexible hose connections for 6" – 12" (152 – 305 mm) installations • Braided flexible supply hoses with 3/8" (10 mm) compression connectors • Metal lever handles • Brass push pop-up drain 		7353841.002	Polished Chrome	442
		7353841.013	Polished Nickel	615
		7353841.243	Matte Black	641
		7353841.278	Legacy Bronze	661
		7353841.295	Brushed Nickel	615
 <p>Townsend® Single Hole Single-Handle Bathroom Faucet 1.2 gpm/4.5 L/min With Lever Handle</p> <ul style="list-style-type: none"> • Brass construction • Washerless ceramic disc valve cartridges • Water-conserving 1.2 gpm/4.5 L/min pressure-compensating aerator • Cast brass spout • Braided flexible supply hoses with 3/8" (10 mm) compression connectors • Metal lever handle • Brass push pop-up drain 		7353101.002	Polished Chrome	323
		7353101.013	Polished Nickel	452
		7353101.243	Matte Black	469
		7353101.278	Legacy Bronze	483
		7353101.295	Brushed Nickel	452
 <p>4-Inch Deck Plate</p> <ul style="list-style-type: none"> • Metal construction • Putty plate included 		7353101P.002	Polished Chrome	46
		7353101P.013	Polished Nickel	63
		7353101P.243	Matte Black	66
		7353101P.278	Legacy Bronze	67
		7353101P.295	Brushed Nickel	63





	Description	SKU #	Color/Finish	List Price
	<p>Townsend® Bathtub Faucet With Lever Handles and Personal Shower for Flash® Rough-In Valve</p> <ul style="list-style-type: none"> • Brass construction • All personal showers feature 5' (152 cm) long hose • Metal lever handles • Personal shower features 1.8 gpm/6.8 L/min maximum flow • For use with Flash® bathtub faucet rough-in valve R910 • Valve sold separately 	<p>CEC T353901.002</p>	<p>Polished Chrome</p>	<p>744</p>
		<p>T353901.013</p>	<p>Polished Nickel</p>	<p>1,042</p>
		<p>T353901.243</p>	<p>Matte Black</p>	<p>1,079</p>
		<p>T353901.278</p>	<p>Legacy Bronze</p>	<p>1,116</p>
		<p>T353901.295</p>	<p>Brushed Nickel</p>	<p>1,042</p>
				
	<p>Townsend® Bathtub Faucet With Lever Handles for Flash® Rough-In Valve</p> <ul style="list-style-type: none"> • Brass construction • Metal lever handles • Less personal shower • For use with Flash® bathtub faucet rough-in valve R900 • Valve sold separately 	<p>ADA T353900.002</p>	<p>Polished Chrome</p>	<p>559</p>
		<p>T353900.013</p>	<p>Polished Nickel</p>	<p>782</p>
		<p>T353900.278</p>	<p>Legacy Bronze</p>	<p>836</p>
		<p>T353900.295</p>	<p>Brushed Nickel</p>	<p>782</p>
				
	<p>Flash® Bathtub Filler Rough-In Valve With Personal Shower</p> <ul style="list-style-type: none"> • Brass construction and washerless ¼-turn ceramic disc valves cartridge • ½" (13 mm) copper inlets • Connections to spout can be made via flexible hoses (provided) or ½" (13 mm) copper sweat connections • 14 gpm/59.2 L/min maximum flow rate at 40 psi • 8"-16" (203-406 mm) flexible installation • Adjustable rough-in: 2-½" (64 mm) maximum deck thickness • Includes hand shower rough-in 	<p>R910</p>	<p>No Finish</p>	<p>322</p>
				
	<p>Flash® Bathtub Filler Rough-In Valve</p> <ul style="list-style-type: none"> • Brass construction and washerless ¼-turn ceramic disc valve cartridges • ½" (13 mm) copper inlets • Connections to spout can be made via flexible hoses (provided) or ½" (13 mm) copper sweat connections • 14 gpm/52.9 L/min maximum flow rate at 40 psi • 8"-16" (203-406 mm) flexible installation • Adjustable rough-in: 2-½" (64 mm) maximum deck thickness 	<p>R900</p>	<p>No Finish</p>	<p>184</p>
				



	Description	SKU #	Color/Finish	List Price
	Townsend® 2.5 gpm/9.5L/min Tub and Shower Trim Kit With Rain Showerhead, Double Ceramic Pressure Balance Cartridge With Lever Handle	TU353502.002	Polished Chrome	342
		TU353502.013	Polished Nickel	467
		TU353502.278	Legacy Bronze	499
		TU353502.295	Brushed Nickel	467
	<ul style="list-style-type: none"> • Includes Double Ceramic pressure balance cartridge • 6" (152 mm) showerhead, 2.5gpm/9.5 L/min maximum flow • Shower arm and flange • Brass wall escutcheon • Metal lever handle • Slip-on diverter tub sprout • For use with Flash® shower rough-in valves 			
	Townsend® 2.5 gpm/9.5L/min Shower Trim Kit With Rain Showerhead, Double Ceramic Pressure Balance Cartridge With Lever Handle	ADA TU353501.002	Polished Chrome	305
		TU353501.013	Polished Nickel	413
		TU353501.278	Legacy Bronze	443
		TU353501.295	Brushed Nickel	413
	<ul style="list-style-type: none"> • Includes Double Ceramic pressure balance cartridge • 6" (152 mm) showerhead, 2.5gpm/9.5 L/min maximum flow • Shower arm and flange • Brass wall escutcheon • Metal lever handle • For use with Flash® shower rough-in valves 			
	Townsend® Valve Only Trim Kit With Double Ceramic Pressure Balance Cartridge and Lever Handle	ADA TU353500.002	Polished Chrome	239
		TU353500.013	Polished Nickel	322
		TU353500.243	Matte Black	347
		TU353500.278	Legacy Bronze	342
		TU353500.295	Brushed Nickel	322
<ul style="list-style-type: none"> • Includes Double Ceramic pressure balance cartridge • Brass wall escutcheon • Metal lever handle • Less valve • For use with Flash® shower rough-in valves 				

Townsend

	Description	SKU #	Color/Finish	List Price
   	<p>Townsend® 1.75gpm/6.6 L/min Tub and Shower Trim Kit With Water-Saving Showerhead, Double Ceramic Pressure Balance Cartridge With Lever Handle</p> <ul style="list-style-type: none"> • Includes Double Ceramic pressure balance cartridge • Water-saving showerhead 1.75gpm/ 6.6 L/min maximum flow • Shower arm and flange • Brass wall escutcheon • Metal lever handle • Slip-on diverter tub sprout • For use with Flash® shower rough-in valves 	<p>CEC</p> <p>TU353508.002 TU353508.013 TU353508.243 TU353508.278 TU353508.295</p>	<p>Polished Chrome Polished Nickel Matte Black Legacy Bronze Brushed Nickel</p>	<p>342 467 496 499 467</p> <p></p>
  	<p>Townsend® 1.75 gpm/6.6 L/min Shower Trim Kit With Water-Saving Showerhead, Double Ceramic Pressure Balance Cartridge With Lever Handle</p> <ul style="list-style-type: none"> • Includes Double Ceramic pressure balance cartridge • Water-saving showerhead 1.75gpm/ 6.6 L/min maximum flow • Shower arm and flange • Brass wall escutcheon • Metal lever handle • For use with Flash® shower rough-in valves 	<p>ADA CEC</p> <p>TU353507.002 TU353507.013 TU353507.243 TU353507.278 TU353507.295</p>	<p>Polished Chrome Polished Nickel Matte Black Legacy Bronze Brushed Nickel</p>	<p>305 413 443 443 413</p> <p></p>

	Description	SKU #	Color/Finish	List Price
	<p>Flash® Shower Rough-In Valve With Universal Inlets/Outlets</p> <ul style="list-style-type: none"> • ½" (13 mm) male NPT/Sweat inlets/outlets accept ½" copper, ½" iron pipe, PEX or CPVC adapters • Cast DZR brass valve body • Flow rate: 5.1 gpm @ 45 psi* • Back-to-back capability • Includes flush plug with stainless steel ring • Cartridge ships with trim • For use with TU series pressure balance bath/shower trim kits 	RU101	No Finish	72
	<p>Flash® Shower Rough-In Valve With Universal Inlets/Outlets With Screwdriver Stops</p> <ul style="list-style-type: none"> • ½" (13 mm) male NPT/Sweat inlets/outlets accept ½" copper, ½" iron pipe, PEX or CPVC adapters • Cast DZR brass valve body • Flow rate: 5.1 gpm @ 45 psi* • Back-to-back capability • Includes flush plug with stainless steel ring • Includes screwdriver stops for easy servicing at the valve • For use with TU series pressure balance bath/shower trim kits 	RU101SS	No Finish	103
	<p>Flash® Shower Rough-In Valve With Stub-Outs</p> <ul style="list-style-type: none"> • ½" (13 mm) Stub-out inlets/outlets accept ½" press-connect fittings • Cast DZR brass valve body • Flow rate: 5.1 gpm @ 45 psi* • Back-to-back capability • Includes flush plug with stainless steel ring • Cartridge ships with trim • For use with TU series pressure balance bath/shower trim kits 	RU102	No Finish	72
	<p>Flash® Shower Rough-In Valve With Stub-Outs With Screwdriver Stops</p> <ul style="list-style-type: none"> • ½" (13 mm) Stub-out inlets/outlets accept ½" press-connect fittings • Cast DZR brass valve body • Flow rate: 5.1 gpm @ 45 psi* • Back-to-back capability • Includes flush plug with stainless steel ring • Includes screwdriver stops for easy servicing at the valve • Cartridge ships with trim • For use with TU series pressure balance bath/shower trim kits 	RU102SS	No Finish	103
	<p>Flash® Shower Rough-In Valve With PEX Inlets/Universal Outlets for Crimp Ring System</p> <ul style="list-style-type: none"> • ½" (3 mm) PEX crimp inlets/Universal outlets (ASTM F1807) • Cast DZR brass valve body • Flow rate: 5.1 gpm @ 45 psi* • Back-to-back capability • Includes flush plug with stainless steel ring • Cartridge ships with trim • For use with TU series pressure balance bath/shower trim kits 	RU107	No Finish	72



*When combined with Double Ceramic pressure balance cartridge.











	Description	SKU #	Color/Finish	List Price
	<p>Flash® Shower Rough-In Valve With PEX Inlets/Universal Outlets With Screwdriver Stops for Crimp Ring System</p> <ul style="list-style-type: none"> • ½" (13 mm) PEX crimp inlets/Universal outlets (ASTM F1807) • Cast DZR brass valve body • Flow rate: 5.1 gpm @ 45 psi* • Back-to-back capability • Includes flush plug with stainless steel ring • Includes screwdriver stops for easy servicing at the valve • Cartridge ships with trim • For use with TU series pressure balance bath/shower trim kits 	RU107SS	No Finish	103 
	<p>Flash® Shower Rough-In Valve With PEX Inlet Elbows/Universal Outlets for Crimp Ring System</p> <ul style="list-style-type: none"> • ½" (13 mm) PEX crimp elbow inlets/Universal outlets (ASTM F1807) • Cast DZR brass valve body • Flow rate: 5.1 gpm @ 45 psi* • Back-to-back capability • Includes flush plug with stainless steel ring • Cartridge ships with trim • For use with TU series pressure balance bath/shower trim kits 	RU107E	No Finish	95 
	<p>Flash® Shower Rough-In Valve With PEX Inlet Elbows/Universal Outlets With Screwdriver Stops for Crimp Ring System</p> <ul style="list-style-type: none"> • ½" (13 mm) PEX crimp elbow inlets/Universal outlets (ASTM F1807) • Cast DZR brass valve body • Flow rate: 5.1 gpm @ 45 psi* • Back-to-back capability • Includes flush plug with stainless steel ring • Includes screwdriver stops for easy servicing at the valve • Cartridge ships with trim • For use with TU series pressure balance bath/shower trim kits 	RU107ESS	No Finish	125 
	<p>Flash® Shower Rough-In Valve With PEX Inlets/Universal Outlets for Cold Expansion System</p> <ul style="list-style-type: none"> • ½" (13 mm) PEX cold expansion inlets/Universal outlets (ASTM F1960) • Cast DZR brass valve body • Flow rate: 5.1 gpm @ 45 psi* • Back-to-back capability • Includes flush plug with stainless steel ring • Cartridge ships with trim • For use with TU series pressure balance bath/shower trim kits 	RU108	No Finish	72 
	<p>Flash® Shower Rough-In Valve With PEX Inlets/Universal Outlets With Screwdriver Stops for Cold Expansion System</p> <ul style="list-style-type: none"> • ½" (13 mm) PEX cold expansion inlets/Universal outlets (ASTM F1960) • Cast DZR brass valve body • Flow rate: 5.1 gpm @ 45 psi* • Back-to-back capability • Includes flush plug with stainless steel ring • Includes screwdriver stops for easy servicing at the valve • For use with TU series pressure balance bath/shower trim kits 	RU108SS	No Finish	103 



















*When combined with Double Ceramic pressure balance cartridge.

	Description	SKU #	Color/Finish	List Price
	<p>Flash® Shower Rough-In Valve With PEX Inlet Elbows/Universal Outlets for Cold Expansion System</p> <ul style="list-style-type: none"> • ½" (13 mm) PEX cold expansion elbow inlets/ Universal outlets (ASTM F1960) • Cast DZR brass valve body • Flow rate: 5.1 gpm @ 45 psi* • Back-to-back capability • Includes flush plug with stainless steel ring • Cartridge ships with trim • For use with TU series pressure balance bath/ shower trim kits 	RU108E	No Finish	95
	<p>Flash® Shower Rough-In Valve With PRX Inlet Elbows/Universal Outlets With Screwdriver Stops for Cold Expansion System</p> <ul style="list-style-type: none"> • ½" (13 mm) PEX cold expansion elbow inlets/ Universal outlets (ASTM F1960) • Cast DZR brass valve body • Flow rate: 5.1 gpm @ 45 psi* • Back-to-back capability • Includes flush plug with stainless steel ring • Includes screwdriver stops for easy servicing at the valve • Cartridge ships with trim • For use with TU series pressure balance bath/ shower trim kits 	RU108ESS	No Finish	125
	<p>Flash® Shower Rough-In Valve With CPVC Inlets/Universal Outlets</p> <ul style="list-style-type: none"> • ½" (13 mm) CPVC inlets/Universal outlets • Cast DZR brass valve body • Flow rate: 5.1 gpm @ 45 psi* • Back-to-back capability • Includes flush plug with stainless steel ring • Cartridge ships with trim • For use with TU series pressure balance bath/ shower trim kits 	RU109	No Finish	95
	<p>Flash® Shower Rough-In Valve With CPVC Inlets/Universal Outlets With Screwdriver Stops</p> <ul style="list-style-type: none"> • ½" (13 mm) CPVC inlets/Universal outlets • Cast DZR brass valve body • Flow rate: 5.1 gpm @ 45 psi* • Back-to-back capability • Includes flush plug with stainless steel ring • Includes screwdriver stops for easy servicing at the valve • Cartridge ships with trim • For use with TU series pressure balance bath/ shower trim kits 	RU109SS	No Finish	125

*When combined with Double Ceramic pressure balance cartridge.

	Description	SKU #	Color/Finish	List Price
	<p>Townsend® 2-Handle Integrated Shower Diverter Trim Only</p> <ul style="list-style-type: none"> • Metal wall escutcheon • Metal lever handles • Works with Flash® 2-Way Integrated Shower Diverter Rough-In Valve with Pressure Balance Valve Cartridge, required and sold separately • Flash® 2-Way Integrated Shower Diverter Rough-In Valve RU521 ships with a 2-way Discrete cartridge • 2-Way Shared capability requires Flash® 2-Way Integrated Shower Diverter Rough-In Valve RU521, plus a 2-Way Shared pressure balance cartridge #M970720-0070A, sold separately • Flash® 3-Way Integrated Shower Diverter Rough-In Valve RU531 ships with a 3-Way Discrete cartridge • 3-Way Shared capability requires Flash® 3-Way Integrated Shower Diverter Rough-In Valve RU531, plus a 3-Way Shared pressure balance cartridge #M970730-0070A, sold separately • 3-way diverter with shared flow requires cartridge M970730-0070A (sold separately) 	<p>ADA</p> <p>TU353740.002</p> <p>TU353740.013</p> <p>TU353740.243</p> <p>TU353740.278</p> <p>TU353740.295</p>	<p>Polished Chrome</p> <p>Polished Nickel</p> <p>Matte Black</p> <p>Legacy Bronze</p> <p>Brushed Nickel</p>	<p>261</p> <p>364</p> <p>378</p> <p>390</p> <p>364</p> <p>MAP SR Q</p>
	<p>Flash® 2-Way Integrated Shower Diverter Rough-In Valve with Pressure Balance Valve Cartridge</p> <ul style="list-style-type: none"> • Made of casted DZR brass to resist corrosion • For use with Flash® 2-Handle Integrated Shower Diverter Trim • ½" NPT Inlets/Outlets • Valve ships with a 2-Way Discrete pressure balance cartridge • 2-Way Shared functionality requires RU521 valve, plus purchase of 2-Way Shared cartridge RP# M970720-0070A, sold separately • Compatible with Delancey®, Serin®, Studio® S, Town Square® S, Times Square® and Townsend® trims • Trim sold separately 	<p>RU521</p>	<p>No Finish</p>	<p>355</p> <p>MAP SR Q</p>
	<p>Flash® 2-Way Shared Diverter Cartridge</p> <ul style="list-style-type: none"> • For use with RU521 valve 	<p>M970720-0070A</p>	<p>No Finish</p>	<p>79</p>
	<p>Flash® 3-Way Integrated Shower Diverter Rough-In Valve with Pressure Balance Valve Cartridge</p> <ul style="list-style-type: none"> • Made of casted DZR brass to resist corrosion • For use with Flash® 2-Handle Integrated Shower Diverter Trim • ½" NPT Inlets/Outlets • Valve ships with a 3-Way Discrete pressure balance cartridge • 3-Way Shared functionality requires RU531 valve, plus purchase of 3-Way Shared cartridge RP# M970730-0070A, sold separately • Compatible with Delancey®, Serin®, Studio® S, Town Square® S, Times Square® and Townsend® trims • Trim sold separately 	<p>RU531</p>	<p>No Finish</p>	<p>385</p> <p>MAP Q</p>
	<p>Flash® 3-Way Shared Diverter Cartridge</p> <ul style="list-style-type: none"> • For use with RU531 valve 	<p>M970730-0070A</p>	<p>No Finish</p>	<p>79</p>

	Description	SKU #	Color/Finish	List Price		
	Townsend® Single-Handle Diverter Valve Trim Kit		T353430.002	Polished Chrome	119	
	<ul style="list-style-type: none"> • Metal lever handle • Less valve (must be purchased separately) • For use with rough-in valves R422, R422S, R433 and R433S 		T353430.013	Polished Nickel	165	
	T353430.278		Legacy Bronze	178		
	T353430.295		Brushed Nickel	165		
						
	2-Way In-Wall Diverter Rough-In Valve With 2 Discrete Functions	R422	No Finish	231		
		<ul style="list-style-type: none"> • Durable cast brass valve body – excellent for high use applications with prolonged water use • Controls water flow between 2 outlets (shower or sprays) • ½" (13 mm) NPT inlets/outlets • Trim must be ordered separately 				
2-Way In-Wall Diverter Rough-In Valve With 2 Discrete/1 Shared Function	R422S	No Finish	231			
	<ul style="list-style-type: none"> • Durable cast brass valve body – excellent for high use applications with prolonged water use • Controls water flow between 2 outlets (shower or sprays) • ½" (13 mm) NPT inlets/outlets • Trim must be ordered separately 					
3-Way In-Wall Diverter Rough-In Valve With 3 Discrete Functions	R433	No Finish	262			
	<ul style="list-style-type: none"> • Durable cast brass valve body – excellent for high use applications with prolonged water use • Controls water flow between 3 outlets (shower or sprays) • ½" (13 mm) NPT inlets/outlets • Trim must be ordered separately 					
3-Way In-Wall Diverter Rough-In Valve With 3 Discrete/3 Shared Functions	R433S	No Finish	262			
	<ul style="list-style-type: none"> • Durable cast brass valve body – excellent for high use applications with prolonged water use • Controls water flow between 3 outlets (shower or sprays) • ½" (13 mm) NPT inlets/outlets • Trim must be ordered separately 					

	Description	SKU #	Color/Finish	List Price
	Townsend® 18-Inch Towel Bar <ul style="list-style-type: none"> • Brass bar • All metal construction • Concealed mounting: no exposed set screws • Coordinates with Townsend® bath faucet collection • Limited lifetime warranty on function and finish 	7353018.002	Polished Chrome	76
		7353018.013	Polished Nickel	104
		7353018.243	Matte Black	110
		7353018.278	Legacy Bronze	112
		7353018.295	Brushed Nickel	104
				 
	Townsend® 24-Inch Towel Bar <ul style="list-style-type: none"> • Brass bar • All metal construction • Concealed mounting: no exposed set screws • Coordinates with Townsend® bath faucet collection • Limited lifetime warranty on function and finish 	7353024.002	Polished Chrome	81
		7353024.013	Polished Nickel	112
		7353024.243	Matte Black	117
		7353024.278	Legacy Bronze	120
		7353024.295	Brushed Nickel	112
				 
	Townsend® Towel Ring <ul style="list-style-type: none"> • Part of the coordinated Townsend® collection • Concealed mounting with no exposed screws for a seamless appearance • Bushing on towel ring to prevent scratching and squeaking • Easy to install • 6-7/8" (175 mm) diameter ring • Limited lifetime warranty on function and finish 	7353190.002	Polished Chrome	50
		7353190.013	Polished Nickel	70
		7353190.243	Matte Black	72
		7353190.278	Legacy Bronze	76
		7353190.295	Brushed Nickel	70
				 
	Townsend® Double Robe Hook <ul style="list-style-type: none"> • All metal construction • Concealed mounting: no exposed set screws • Coordinates with Townsend® bath faucet collection • Easy to install • Limited lifetime warranty on function and finish • Solid metal construction is durable and long-lasting 	7353210.002	Polished Chrome	35
		7353210.013	Polished Nickel	49
		7353210.243	Matte Black	51
		7353210.278	Legacy Bronze	52
		7353210.295	Brushed Nickel	49
				 
	Townsend® 24-Inch Double Towel Bar <ul style="list-style-type: none"> • Brass bar • All metal construction • Concealed mounting: no exposed set screws • Coordinates with Townsend® bath faucet collection • Limited lifetime warranty on function and finish 	7353224.002	Polished Chrome	149
		7353224.013	Polished Nickel	210
		7353224.243	Matte Black	216
		7353224.278	Legacy Bronze	225
		7353224.295	Brushed Nickel	210
				 
	Townsend® Toilet Paper Holder <ul style="list-style-type: none"> • Pivoting arm • All metal construction • Coordinates with Townsend® bath faucet collection • Easy to install • Limited lifetime warranty on function and finish 	7353230.002	Polished Chrome	60
		7353230.013	Polished Nickel	84
		7353230.243	Matte Black	88
		7353230.278	Legacy Bronze	89
		7353230.295	Brushed Nickel	84
				 

Bathroom Accessories

Every bathroom deserves accessories that offer functionality and the perfect finishing touch. These essential pieces are designed with attention to detail, reflecting the nuances of our collections and adding distinction to this personal space.



Bathroom Accessories

Bathroom Accessories Overview

CONTEMPORARY

Studio® S

Studio S



Studio S Towel Ring
7105190

Studio S Double Robe Hook
7105210

TRADITIONAL

Delancey®

Delancey



Delancey Towel Ring
7052190

Delancey Double Robe Hook
7052210

Glenmere™

Glenmere



Glenmere Towel Ring
7617190

Glenmere Robe Hook
7617210

Town Square® S

Crawford, Town Square S



Town Square S Towel Ring
7455190

Town Square S Robe Hook
7455210

TRANSITIONAL

C Series

Colony PRO®,
Fluent®, Reliant 3®



C Series Towel Ring
8337190

C Series Double Robe Hook
8337210

Edgemere®

Edgemere



Edgemere Towel Ring
7018190

Edgemere Robe Hook
7018210















Townsend®















Townsend







Townsend Towel Ring
7353190

Townsend Double Robe Hook
7353210















	Description	SKU #	Color/Finish	List Price
	Studio® S 18-Inch Towel Bar <ul style="list-style-type: none"> • Brass bar • All metal construction • Concealed mounting: no exposed set screws • Coordinates with Studio® S bath faucet collection • Limited lifetime warranty on function and finish 	7105018.002	Polished Chrome	65
		7105018.243	Matte Black	100
		7105018.295	Brushed Nickel	90
				 
	Studio® S 24-Inch Towel Bar <ul style="list-style-type: none"> • Brass bar • All metal construction • Concealed mounting: no exposed set screws • Coordinates with Studio® S bath faucet collection • Limited lifetime warranty on function and finish 	7105024.002	Polished Chrome	68
		7105024.243	Matte Black	106
		7105024.295	Brushed Nickel	96
				 
	Studio® S Towel Ring <ul style="list-style-type: none"> • Coordinates with Studio® S bath faucet collection • Concealed mounting with no exposed screws for a seamless appearance • Easy to install • Limited lifetime warranty on function and finish 	7105190.002	Polished Chrome	41
		7105190.243	Matte Black	63
		7105190.295	Brushed Nickel	57
				 
	Studio® S Double Robe Hook <ul style="list-style-type: none"> • Solid metal construction is durable and long-lasting • Concealed mounting: no exposed set screws • Coordinates with Studio® S bath faucet collection • Easy to install • Limited lifetime warranty on function and finish 	7105210.002	Polished Chrome	31
		7105210.243	Matte Black	47
		7105210.295	Brushed Nickel	43
				 
	Studio® S 24-Inch Double Towel Bar <ul style="list-style-type: none"> • Brass bar • All metal construction • Concealed mounting: no exposed set screws • Coordinates with Studio® S bath faucet collection • Limited lifetime warranty on function and finish 	7105224.002	Polished Chrome	137
		7105224.243	Matte Black	205
		7105224.295	Brushed Nickel	192
				 
	Studio® S Toilet Paper Holder <ul style="list-style-type: none"> • All metal construction • Concealed mounting: no exposed set screws • Coordinates with Studio® S bath faucet collection • Easy to install • Limited lifetime warranty on function and finish 	7105230.002	Polished Chrome	52
		7105230.243	Matte Black	82
		7105230.295	Brushed Nickel	74
				 

	Description	SKU #	Color/Finish	List Price
	Delancey® 18-Inch Towel Bar <ul style="list-style-type: none"> • Brass bar • All metal construction • Concealed mounting: no exposed set screws • Coordinates with Delancey® bath faucet collection • Limited lifetime warranty on function and finish 	7052018.002	Polished Chrome	76
		7052018.013	Polished Nickel	105
		7052018.278	Legacy Bronze	113
		7052018.295	Brushed Nickel	105
		 		
	Delancey® 24-Inch Towel Bar <ul style="list-style-type: none"> • Brass bar • All metal construction • Concealed mounting: no exposed set screws • Coordinates with Delancey® bath faucet collection • Limited lifetime warranty on function and finish 	7052024.002	Polished Chrome	82
		7052024.013	Polished Nickel	113
		7052024.278	Legacy Bronze	122
		7052024.295	Brushed Nickel	113
		 		
	Delancey® Towel Ring <ul style="list-style-type: none"> • 7-¼" (185 mm) diameter ring • All metal construction • Concealed mounting: no exposed set screws • Coordinates with Delancey® bath faucet collection • Bushing on towel ring to prevent scratching and squeaking • Limited lifetime warranty on function and finish 	7052190.002	Polished Chrome	47
		7052190.013	Polished Nickel	65
		7052190.278	Legacy Bronze	70
		7052190.295	Brushed Nickel	65
		 		
	Delancey® Double Robe Hook <ul style="list-style-type: none"> • All metal construction • Concealed mounting: no exposed set screws • Coordinates with Delancey® bath faucet collection • Easy to install • Limited lifetime warranty on function and finish • Solid metal construction is durable and long-lasting 	7052210.002	Polished Chrome	35
		7052210.013	Polished Nickel	49
		7052210.278	Legacy Bronze	52
		7052210.295	Brushed Nickel	49
		 		
	Delancey® Toilet Paper Holder <ul style="list-style-type: none"> • All metal construction • Concealed mounting: no exposed set screws • Coordinates with Delancey® bath faucet collection • Easy to install • Limited lifetime warranty on function and finish 	7052230.002	Polished Chrome	64
		7052230.013	Polished Nickel	89
		7052230.278	Legacy Bronze	96
		7052230.295	Brushed Nickel	89
		 		

	Description	SKU #	Color/Finish	List Price
	Glenmere™ 24-inch Towel Bar • All metal construction • Concealed mounting	7617024.002	Polished Chrome	57
		7617024.243	Matte Black	84
		7617024.278	Legacy Bronze	75
		7617024.295	Brushed Nickel	65
		<hr/>		
	Glenmere™ Towel Ring • 7" (178 mm) diameter ring • All metal construction • Concealed mounting	7617190.002	Polished Chrome	41
		7617190.243	Matte Black	60
		7617190.278	Legacy Bronze	54
		7617190.295	Brushed Nickel	47
		<hr/>		
	Glenmere™ Robe Hook • All metal construction • Concealed mounting	7617210.002	Polished Chrome	31
		7617210.243	Matte Black	46
		7617210.278	Legacy Bronze	42
		7617210.295	Brushed Nickel	36
		<hr/>		
	Glenmere™ Toilet Paper Holder • All metal construction • Concealed mounting	7617230.002	Polished Chrome	50
		7617230.243	Matte Black	74
		7617230.278	Legacy Bronze	68
		7617230.295	Brushed Nickel	46

Town Square® S















Traditional Bathroom Accessories





	Description	SKU #	Color/Finish	List Price
	Town Square® S 18-Inch Towel Bar	7455018.002	Polished Chrome	70
	• Brass bar	7455018.013	Polished Nickel	96
	• All metal construction	7455018.278	Legacy Bronze	104
	• Concealed mounting: no exposed set screws	7455018.295	Brushed Nickel	96
	• Coordinates with Town Square® S bath faucet collection			
	• Limited lifetime warranty on function and finish			
				 
	Town Square® S 24-Inch Towel Bar	7455024.002	Polished Chrome	76
	• Brass bar	7455024.013	Polished Nickel	105
	• All metal construction	7455024.278	Legacy Bronze	112
	• Concealed mounting: no exposed set screws	7455024.295	Brushed Nickel	105
	• Coordinates with Town Square® S bath faucet collection			
	• Limited lifetime warranty on function and finish			
				 
	Town Square® S Towel Ring	7455190.002	Polished Chrome	45
	• Part of the coordinated Town Square S® collection	7455190.013	Polished Nickel	61
	• Concealed mounting with no exposed screws for a seamless appearance	7455190.278	Legacy Bronze	66
	• Bushing on towel ring to prevent scratching and squeaking	7455190.295	Brushed Nickel	61
	• Easy to install			
	• 7" (178 mm) diameter ring			
	• Limited lifetime warranty on function and finish			
				 
	Town Square® S Double Robe Hook	7455210.002	Polished Chrome	32
	• All metal construction	7455210.013	Polished Nickel	45
	• Concealed mounting: no exposed set screws	7455210.278	Legacy Bronze	45
	• Coordinates with Town Square S® bath faucet collection	7455210.295	Brushed Nickel	45
	• Easy to install			
	• Limited lifetime warranty on function and finish			
	• Solid metal construction is durable and long-lasting			
				 
	Town Square® S Toilet Paper Holder	7455230.002	Polished Chrome	57
	• All metal construction	7455230.013	Polished Nickel	80
	• Concealed mounting: no exposed set screws	7455230.278	Legacy Bronze	86
	• Coordinates with Town Square® S bath faucet collection	7455230.295	Brushed Nickel	80
	• Easy to install			
	• Limited lifetime warranty on function and finish			
				 
	Town Square® S 24-Inch Train Rack	7455260.002	Polished Chrome	496
	• 24" (600 mm) length	7455260.013	Polished Nickel	695
	• All metal construction	7455260.278	Legacy Bronze	744
	• Concealed mounting: no exposed set screws	7455260.295	Brushed Nickel	695
	• Coordinates with Town Square® S bath faucet collection			
	• Limited lifetime warranty on function and finish			
				 

Bathroom Accessories

C Series

Transitional Bathroom Accessories

	Description	SKU #	Color/Finish	List Price
	C Series 18-Inch Towel Bar	8337018.002	Polished Chrome	66
	• Brass bar	8337018.013	Polished Nickel	92
	• All metal construction	8337018.278	Legacy Bronze	100
	• Concealed mounting: no exposed set screws	8337018.295	Brushed Nickel	92
	• Easy to install			
	• Limited lifetime warranty on function and finish			
			 	
	C Series 24-Inch Towel Bar	8337024.002	Polished Chrome	70
	• Brass bar	8337024.013	Polished Nickel	98
	• All metal construction	8337024.278	Legacy Bronze	104
	• Concealed mounting: no exposed set screws	8337024.295	Brushed Nickel	98
	• Easy to install			
	• Limited lifetime warranty on function and finish			
			 	
	C Series Towel Ring	8337190.002	Polished Chrome	41
	• Concealed mounting with no exposed screws for a seamless appearance	8337190.013	Polished Nickel	57
	• Bushing on towel ring to prevent scratching and squeaking	8337190.278	Legacy Bronze	61
	• Easy to install	8337190.295	Brushed Nickel	57
	• 7" (178 mm) diameter ring			
	• Limited lifetime warranty on function and finish			
			 	
	C Series Double Robe Hook	8337210.002	Polished Chrome	31
	• All metal construction	8337210.013	Polished Nickel	43
	• Concealed mounting: no exposed set screws	8337210.278	Legacy Bronze	43
	• Easy to install	8337210.295	Brushed Nickel	43
	• Limited lifetime warranty on function and finish			
	• Solid metal construction is durable and long-lasting			
			 	
	C Series Toilet Paper Holder	8337230.002	Polished Chrome	53
	• All metal construction	8337230.013	Polished Nickel	76
	• Concealed mounting: no exposed set screws	8337230.278	Legacy Bronze	82
	• Easy to install	8337230.295	Brushed Nickel	76
	• Limited lifetime warranty on function and finish			
			 	

	Description	SKU #	Color/Finish	List Price
	Edgemere® 18-Inch Towel Bar <ul style="list-style-type: none"> • Brass bar • All metal construction • Concealed mounting: no exposed set screws • Coordinates with Edgemere® bath faucet collection • Limited lifetime warranty on function and finish 	7018018.002	Polished Chrome	66
		7018018.243	Matte Black	95
		7018018.278	Legacy Bronze	100
		7018018.295	Brushed Nickel	93
	Edgemere® 24-Inch Towel Bar <ul style="list-style-type: none"> • Brass bar • All metal construction • Concealed mounting: no exposed set screws • Coordinates with Edgemere® bath faucet collection • Limited lifetime warranty on function and finish 	7018024.002	Polished Chrome	74
		7018024.243	Matte Black	108
		7018024.278	Legacy Bronze	108
		7018024.295	Brushed Nickel	101
	Edgemere® Towel Ring <ul style="list-style-type: none"> • 7-1/4" (185 mm) diameter ring • All metal construction • Concealed mounting: no exposed set screws • Coordinates with Edgemere® bath faucet collection • Limited lifetime warranty on function and finish 	7018190.002	Polished Chrome	49
		7018190.243	Matte Black	71
		7018190.278	Legacy Bronze	74
		7018190.295	Brushed Nickel	68
	Edgemere® Double Robe Hook <ul style="list-style-type: none"> • All metal construction • Concealed mounting: no exposed set screws • Coordinates with Edgemere® bath faucet collection • Easy to install • Limited lifetime warranty on function and finish • Solid metal construction is durable and long-lasting 	7018210.002	Polished Chrome	36
		7018210.243	Matte Black	52
		7018210.278	Legacy Bronze	54
		7018210.295	Brushed Nickel	51
	Edgemere® Toilet Paper Holder <ul style="list-style-type: none"> • Pivoting arm • All metal construction • Coordinates with Edgemere® bath faucet collection • Easy to install • Limited lifetime warranty on function and finish 	7018230.002	Polished Chrome	54
		7018230.243	Matte Black	78
		7018230.278	Legacy Bronze	83
		7018230.295	Brushed Nickel	77

	Description	SKU #	Color/Finish	List Price
	Townsend® 18-Inch Towel Bar <ul style="list-style-type: none"> • Brass bar • All metal construction • Concealed mounting: no exposed set screws • Coordinates with Townsend® bath faucet collection • Limited lifetime warranty on function and finish 	7353018.002	Polished Chrome	76
		7353018.013	Polished Nickel	104
		7353018.243	Matte Black	110
		7353018.278	Legacy Bronze	112
		7353018.295	Brushed Nickel	104
				 
	Townsend® 24-Inch Towel Bar <ul style="list-style-type: none"> • Brass bar • All metal construction • Concealed mounting: no exposed set screws • Coordinates with Townsend® bath faucet collection • Limited lifetime warranty on function and finish 	7353024.002	Polished Chrome	81
		7353024.013	Polished Nickel	112
		7353024.243	Matte Black	117
		7353024.278	Legacy Bronze	120
		7353024.295	Brushed Nickel	112
				 
	Townsend® Towel Ring <ul style="list-style-type: none"> • Part of the coordinated Townsend® collection • Concealed mounting with no exposed screws for a seamless appearance • Bushing on towel ring to prevent scratching and squeaking • Easy to install • 6-7/8" (175 mm) diameter ring • Limited lifetime warranty on function and finish 	7353190.002	Polished Chrome	50
		7353190.013	Polished Nickel	70
		7353190.243	Matte Black	72
		7353190.278	Legacy Bronze	76
		7353190.295	Brushed Nickel	70
				 
	Townsend® Double Robe Hook <ul style="list-style-type: none"> • All metal construction • Concealed mounting: no exposed set screws • Coordinates with Townsend® bath faucet collection • Easy to install • Limited lifetime warranty on function and finish • Solid metal construction is durable and long-lasting 	7353210.002	Polished Chrome	35
		7353210.013	Polished Nickel	49
		7353210.243	Matte Black	51
		7353210.278	Legacy Bronze	52
		7353210.295	Brushed Nickel	49
				 
	Townsend® 24-Inch Double Towel Bar <ul style="list-style-type: none"> • Brass bar • All metal construction • Concealed mounting: no exposed set screws • Coordinates with Townsend® bath faucet collection • Limited lifetime warranty on function and finish 	7353224.002	Polished Chrome	149
		7353224.013	Polished Nickel	210
		7353224.243	Matte Black	216
		7353224.278	Legacy Bronze	225
		7353224.295	Brushed Nickel	210
				 
	Townsend® Toilet Paper Holder <ul style="list-style-type: none"> • Pivoting arm • All metal construction • Coordinates with Townsend® bath faucet collection • Easy to install • Limited lifetime warranty on function and finish 	7353230.002	Polished Chrome	60
		7353230.013	Polished Nickel	84
		7353230.243	Matte Black	88
		7353230.278	Legacy Bronze	89
		7353230.295	Brushed Nickel	84
				 

Notes

Showering Options

Transform your shower into an experience. The **Spectra Versa® Retrofit Shower System** allows you to use your existing shower valve, so there is no need to drill or alter your plumbing. Spectra Versa is a great option for that quick shower overhaul you've been planning.



Showering Options

Spectra Versa® Retrofit Shower System

30-Minute Makeover From Everyday Shower to Personal Spa Experience

Transform your shower into an experience, in minutes. Spectra Versa Retrofit allows you to use your existing shower valve, so there is no need to drill or alter your plumbing. Spectra Versa is a great option for that quick shower overhaul you've been planning.



Easy to Install

Spectra Versa Retrofit eliminates the need to drill holes and damage tiles



AquaToggle™

Easily switch between four spray functions with one hand



Easy Glide Holder

Adjust height and angle of hand shower for personal preference



3-Function Push-Button Diverter

Switch between showerhead and hand shower for use alone or together

Showering Options

Spectra® Shower Collection

Technology and Flexibility for Showering Perfection

The full Spectra Shower Portfolio offers flexibility along with total control. Technically advanced, functionally flexible and easy to install, you can choose the Spectra Showering System that will accommodate every member of the family, in the perfect style and finish.

Spectra Technology



Spectra eTouch®

Mount the waterproof remote anywhere in the shower. Simply click to experience and change the four spray patterns.



Spectra Touch®

Adjust the shower spray with a simple touch. Tap the outer ring of the 7" showerhead to change the four-function spray patterns.

Spectra Spray Patterns

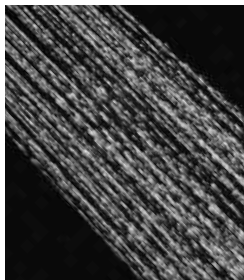

Drench
Full body coverage

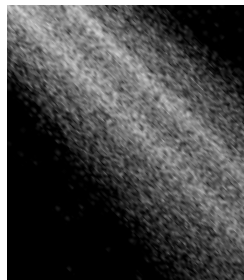

Sensitive
Gentle, soothing coverage

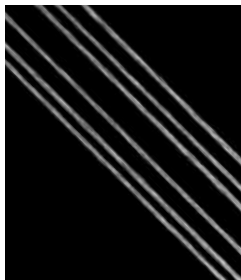

Jet
Targeted coverage

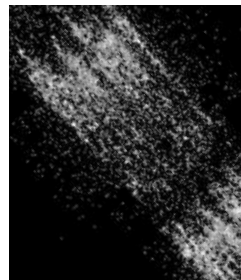

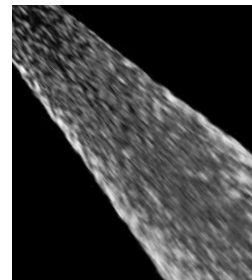

Massage
Pulsating coverage



PowerWash®
Sweeping coverage





Shower Systems

Showering Options

	Description	SKU #	Color/Finish	List Price
	<p>Spectra Versa® 24-Inch 4-Function 1.8 gpm/6.8 L/min Shower System With Rain Showerhead</p> <ul style="list-style-type: none"> • System includes 11" Rain showerhead, 4-function hand shower, 25" slide bar with Easy Glide, push-button diverter, 15" shower arm, 69" metal shower hose, adhesive tape and screws • Easy installation for retrofit, renovation or new construction eliminates drilling or damage to tile • Enjoy using showerhead and hand shower, alone or together • Hand shower features Drench, PowerWash, Sensitive, and Massage spray functions • Push-button diverter easily switches between water outlets or combines both • Maintains flow rate of 1.8 gallons per minute even when using both showerhead and handshower • Rubber nozzles wipe clean with your fingertip 	<p>CEC</p> <p>9038804.002</p> <p>9038804.243</p> <p>9038804.278</p> <p>9038804.295</p>	<p>Polished Chrome</p> <p>Matte Black</p> <p>Legacy Bronze</p> <p>Brushed Nickel</p>	<p>500</p> <p>725</p> <p>690</p> <p>591</p>
	<p>Spectra Versa® 24-Inch 4-Function 1.8 gpm/6.8 L/min Hand Shower Kit</p> <ul style="list-style-type: none"> • System includes 7" four-spray showerhead, hand shower, push-button diverter, slide bar with Easy Glide tab, 69" metal shower hose, adhesive tape and screws • Easy installation for retrofit, renovation or new construction eliminates drilling or damage to tile • Enjoy using showerhead and hand shower, alone or together • Hand shower features Drench, PowerWash, Sensitive, and Massage spray functions • Push-button diverter easily switches between water outlets or combines both • Maintains flow rate of 1.8 gallons per minute even when using both showerhead and handshower • Rubber nozzles wipe clean with your fingertip 	<p>CEC</p> <p>9038824.002</p>	<p>Polished Chrome</p>	<p>411</p>
	<p>Spectra Versa® 5-Inch Showerhead Arm Extension</p> <ul style="list-style-type: none"> • Raises Rain shower head 5" to fully experience a drenching sensation • Simple solution for taller members of the household • Easy installation on slide bar • Available in three finishes to match Spectra Versa® System 	<p>9035888.002</p> <p>9035888.278</p> <p>9035888.295</p>	<p>Polished Chrome</p> <p>Legacy Bronze</p> <p>Brushed Nickel</p>	<p>55</p> <p>84</p> <p>72</p>





Shower Systems

Showering Options

	Description	SKU #	Color/Finish	List Price
 	<p>Spectra Versa® 36-Inch 4-Function 1.8 gpm/6.8 L/min Hand Shower Kit</p> <ul style="list-style-type: none"> • System includes 7" four-spray showerhead, hand shower, push-button diverter, slide bar with Easy Glide tab, 69" metal shower hose, adhesive tape and screws • Easy installation for retrofit, renovation or new construction eliminates drilling or damage to tile • Enjoy using showerhead and hand shower, alone or together • Hand shower features Drench, PowerWash, Sensitive, and Massage spray functions • Push-button diverter easily switches between water outlets or combines both • Maintains flow rate of 1.8 gallons per minute even when using both showerhead and handshower • Rubber nozzles wipe clean with your fingertip 	 <p>9038834.002</p>	<p>Polished Chrome</p>	<p>466</p> 

2-in-1 Hand Showers





Showering Options

	Description	SKU #	Color/Finish	List Price
 	<p>Spectra® Duo 1.8 gpm/6.8 L/min 2-in-1 Hand Shower</p> <ul style="list-style-type: none"> • 2-in-1 design, with a wide showerhead and hand shower combination • 4-function hand shower adjusts from drench to sensitive to PowerWash® to massage • AquaToggle™ easily changes sprays for hand shower • DivertPaddle™ allows for an easy switch between spray heads • Pressure-compensating flow control device • Includes check valve • Includes 59" (1499 mm) metal hose • Limited lifetime warranty • 1.8 gpm/6.8 L/min maximum flow rate 	 <p>9038254.002 9038254.013 9038254.243 9038254.278 9038254.295</p>	<p>Polished Chrome Polished Nickel Matte Black Legacy Bronze Brushed Nickel</p>	<p>173 234 250 247 234</p> 

Showering Options

Fixed Showerheads





















Showering Options

	Description	SKU #	Color/Finish	List Price
	Spectra Fixed™ 7-Inch 1.8 gpm/6.8 L/min Fixed Showerhead <ul style="list-style-type: none"> • 7" (178 mm) easy clean showerhead • 4-functions adjust from drench to sensitive to jet to massage • Pressure-compensating flow control device • Showerhead only • 1.8 gpm/6.8 L/min maximum flow • Limited lifetime warranty • Beautiful finishes that are scratch and tarnish resistant 	9038074.002	Polished Chrome	99
		9038074.243	Matte Black	143
		9038074.278	Legacy Bronze	136
		9038074.295	Brushed Nickel	123
	Spectra® eTouch 7-Inch 1.8 gpm/6.8 L/min Water-Saving Fixed Showerhead <ul style="list-style-type: none"> • 7" (178 mm) easy clean showerhead with remote • Touch showerhead outer ring or press remote to change sprays • 4-functions adjust from drench to sensitive to jet to massage • Pressure-compensating flow control device • Showerhead and remote only • 3 AA batteries included for showerhead • 3v lithium battery and mounting supplies included for remote • 1.8 gpm/6.8 L/min maximum flow • 5-year limited warranty 	9038474.002	Polished Chrome	210
		9038474.013	Polished Nickel	268
		9038474.278	Legacy Bronze	297
		9038474.295	Brushed Nickel	284
	Spectra® Touch 7-Inch 1.8 gpm/6.8 L/min Water-Saving Fixed Showerhead <ul style="list-style-type: none"> • 7" (178 mm) easy clean showerhead • Touch showerhead outer ring to change sprays • 4-functions adjust from drench to sensitive to jet to massage • Pressure-compensating flow control device • Showerhead only • 3 AA batteries included for showerhead • 1.8 gpm/6.8 L/min maximum flow • 5-year limited warranty • Easy Clean Spray Nozzles simplify the cleaning process for your showerhead 	9038374.295	Brushed Nickel	223
	Spectra® Fixed Traditional 7-1/4-Inch 1.8 gpm/6.8 L/min Water-Saving Fixed Showerhead <ul style="list-style-type: none"> • 7-1/4" (184 mm) easy clean showerhead • 4-functions adjust from drench to sensitive to jet to massage • Pressure-compensating flow control device • Showerhead only • 1.8 gpm/6.8 L/min maximum flow • Limited lifetime warranty • Beautiful finishes that are scratch and tarnish resistant 	9138073.002	Polished Chrome	111
		9138073.013	Polished Nickel	137
		9138073.278	Legacy Bronze	148
		9138073.295	Brushed Nickel	137
	Town Square® S 6-1/4-Inch 2.5 gpm/9.5 L/min Fixed Showerhead <ul style="list-style-type: none"> • Easy to clean • 6-1/4" (160 mm) single function showerhead • Showerhead only • Pressure-compensating flow control device • 2.5 gpm/9.5 L/min maximum flow rate • Drenching single-function shower flow • Easy to clean spray nozzles won't clog • Pressure-compensating flow control device 	1660516.002	Polished Chrome	93
		1660516.013	Polished Nickel	130
		1660516.278	Legacy Bronze	141
		1660516.295	Brushed Nickel	130

Showering Options









Fixed Showerheads

Showering Options

	Description	SKU #	Color/Finish	List Price
 	Town Square® S 6-1/4-Inch 1.8 gpm/6.8 L/min Fixed Showerhead <ul style="list-style-type: none"> • Easy to clean • 6-1/4" (160 mm) single function showerhead • Showerhead only • Pressure-compensating flow control device • 1.8 gpm/6.8 L/min maximum flow rate • Saves 30% more water when compared to a standard 2.5 gpm showerhead • Easy to clean spray nozzles won't clog • CEC compliant product 	CEC 1660515.002	Polished Chrome	93
		1660515.013	Polished Nickel	130
		1660515.278	Legacy Bronze	141
		1660515.295	Brushed Nickel	130
  				
 	Townsend® 6-Inch 1.8 gpm/6.8 L/min Water-Saving Fixed Showerhead <ul style="list-style-type: none"> • Easy to clean • 6" (152 mm) diameter head • Showerhead only • Pressure-compensating flow control device • 1.8 gpm/6.8 L/min maximum flow rate • Saves 30% more water when compared to a standard 2.5 gpm showerhead • Architecturally inspired design coordinates perfectly with the rest of the Townsend Collection • Easy to clean spray nozzles won't clog • WaterSense Certified to help save water • 1.8 gallons per minute (1.8 gpm/6.8 L/min.) maximum flow rate • 6-1/8" showerhead • Showerhead only • Pressure-compensating flow control device 	CEC 1660509.002	Polished Chrome	106
		1660509.013	Polished Nickel	151
		1660509.243	Matte Black	130
		1660509.278	Legacy Bronze	162
		1660509.295	Brushed Nickel	151
  				
 	Fluent® 7-Inch 2.5 gpm/9.5 L/min Fixed Showerhead <ul style="list-style-type: none"> • Easy to clean • 7" (178 mm) diameter head • Showerhead only • Pressure-compensating flow control device • 2.5 gpm/9.5 L/min maximum flow rate 	1660604.002	Polished Chrome	95
		 		
 	Hydrofocus® 4-1/2-Inch 2.0 gpm/7.6 L/min Water-Saving Fixed Showerhead <ul style="list-style-type: none"> • 4-1/2" (114 mm) diameter easy clean showerhead • Adjusts from massage to full/massage combination to full spray to hydrofocus concentrating spray to hydrofocus/full combination to pause • Pressure-compensating flow control device • Showerhead only • 2.0 gpm/7.6 L/min maximum flow • 5 spray patterns to select the type of spray best suited to your needs • Pressure-compensating flow control device provides a consistent flow over a wide pressure range 	CEC 1660206.002	Polished Chrome	57
		1660206.295	Brushed Nickel	76
				
 	3-Function 4-3/4-Inch 1.8 gpm/6.8 L/min Water-Saving Showerhead <ul style="list-style-type: none"> • Showerhead only • 4-3/4" (121 mm) diameter easy clean showerhead • Adjusts from gentle rain to hard rain to massage • Pressure-compensating flow control device • 1.75 gpm/6.6L/min. flow restrictor 	CEC 1660652.002	Polished Chrome	113
		1660652.295	Brushed Nickel	171
 				

Fixed Showerheads



















Showering Options

	Description	CEC	SKU #	Color/Finish	List Price
 	FloWise™ Modern 2.0 gpm/7.6 L/min Water-Saving Fixed Showerhead <ul style="list-style-type: none"> FloWise™ 3-function showerhead with 2.0 gpm/7.6 L/min maximum flow Showerhead only Up to 40% water savings Three spray settings: Turbine spray at 1.5 gpm maximum flow rate, Full spray at 2.0 gpm maximum flow rate, and Combination spray at 2.0 gpm maximum flow rate Auto return feature defaults to 1.5 gpm ultra water-saving mode Angle adjustable Pressure-compensating flow control device 		1660613.002	Polished Chrome	93
 	FloWise™ Square 2.0 gpm/7.6 L/min Water-Saving Fixed Showerhead <ul style="list-style-type: none"> FloWise™ 3-function showerhead with 2.0 gpm/7.6 L/min maximum flow Showerhead only Up to 40% water savings Three spray settings: Turbine spray at 1.5 gpm maximum flow rate, Full spray at 2.0 gpm maximum flow rate, and Combination spray at 2.0 gpm maximum flow rate Auto return feature defaults to 1.5 gpm ultra water-saving mode Angle adjustable Pressure-compensating flow control device Auto return feature defaults at 1.5 gpm 		1660813.002 1660813.224	Polished Chrome Oil Rubbed Bronze	87 133
 	FloWise™ Transitional 2.0 gpm/7.6 L/min Water-Saving Fixed Showerhead <ul style="list-style-type: none"> FloWise™ 3-function showerhead with 2.0 gpm/7.6 L/min maximum flow Showerhead only Up to 40% water savings Three spray settings: Turbine spray at 1.5 gpm maximum flow rate, Full spray at 2.0 gpm maximum flow rate, and Combination spray at 2.0 gpm maximum flow rate Auto return feature defaults to 1.5 gpm ultra water-saving mode Angle adjustable Pressure-compensating flow control device 		1660717.002	Polished Chrome	87
 	FloWise™ Traditional 2.0 gpm/7.6 L/min Water-Saving Fixed Showerhead <ul style="list-style-type: none"> FloWise™ 3-function showerhead with 2.0 gpm/7.6 L/min maximum flow Showerhead only Up to 40% water savings Three spray settings: Turbine spray at 1.5 gpm maximum flow rate, full spray at 2.0 gpm maximum flow rate, and combination spray at 2.0 gpm maximum flow rate Auto return feature defaults to 1.5 gpm ultra water-saving mode Angle adjustable Pressure-compensating flow control device 		1660113.002 1660113.224	Polished Chrome Oil Rubbed Bronze	84 125

Showering Options

















Fixed Showerheads

Showering Options

	Description	SKU #	Color/Finish	List Price
 	FloWise™ Square 1.5 gpm/5.7 L/min Water-Saving Fixed Showerhead <ul style="list-style-type: none"> • FloWise™ single function showerhead with 1.5 gpm/5.7 L/min maximum flow • Showerhead only • 40% water savings • Turbine spray at maximum 1.5 gpm flow rate • Angle adjustable • Pressure-compensating flow control device • FloWise™ showerheads use our exclusive turbine technology to deliver an invigorating shower experience while saving water. These innovative heads can save a family up to 8,000 gallons of water a year 	 1660811.002	Polished Chrome	61 
 	FloWise™ 1.5 gpm/5.7 L/min Water-Saving Fixed Showerhead <ul style="list-style-type: none"> • FloWise™ single function showerhead with 1.5 gpm/5.7 L/min maximum flow • Showerhead only • 40% water savings • Turbine spray at maximum 1.5 gpm flow rate • Angle adjustable • Pressure-compensating flow control device • FloWise™ showerheads use our exclusive turbine technology to deliver an invigorating shower experience while saving water. These innovative heads can save a family up to 8,000 gallons of water a year. 	 1660710.002	Polished Chrome	32
 	Spectra® Rain 11-Inch 1.8 gpm/6.8 L/min Water-Saving Rain Showerhead <ul style="list-style-type: none"> • Showerhead only • 11" (280 mm) easy clean showerhead • Single function drench spray • Pressure-compensating flow control device • 2.5 gpm/9.5 L/min maximum flow rate • Drenching shower spray that mimics the feeling of rain • Easy to clean spray nozzles • Beautiful finishes that are scratch and tarnish resistant 	 9038001.002 9038001.243 9038001.278 9038001.295	Polished Chrome Matte Black Legacy Bronze Brushed Nickel	197 286 271 247 
	Modern 10-Inch 2.5 gpm/9.5 L/min Rain Showerhead <ul style="list-style-type: none"> • Showerhead only • Easy clean showerhead • Sleek, thin profile • Brass construction • Pressure-compensating flow control device • 2.5 gpm/9.5 L/min maximum flow rate • 10" Diameter • Drenching Rain Water Flow 	1660683.002 1660683.243 1660683.295	Polished Chrome Matte Black Brushed Nickel	296 429 443  
	Studio® S 8-Inch 2.5 gpm/9.5 L/min Rain Showerhead <ul style="list-style-type: none"> • Showerhead only • Easy clean showerhead • Sleek, thin profile • Pressure-compensating flow control device • 2.5 gpm/9.5 L/min maximum flow rate • Easy clean shower head for simple removal of calcium and lime build up • Brass construction 	1660527.002 1660527.243 1660527.295	Polished Chrome Matte Black Brushed Nickel	109 164 153   





Fixed Showerheads

Showering Options

	Description	SKU #	Color/Finish	List Price	
 	Studio® S 8-Inch 1.8 gpm/6.8 L/min Water-Saving Rain Showerhead <ul style="list-style-type: none"> • Showerhead only • Easy clean showerhead • Sleek, thin profile • Pressure-compensating flow control device • 1.8 gpm/6.8 L/min maximum flow • Easy clean shower head for simple removal of calcium and lime build up • Brass construction 		1660528.002	Polished Chrome	109
			1660528.243	Matte Black	164
			1660528.295	Brushed Nickel	153
					  
 	Square 8-Inch 1.8 gpm/6.8 L/min Water-Saving Rain Showerhead <ul style="list-style-type: none"> • Showerhead only • Easy clean showerhead • Sleek, thin profile • Brass construction • Pressure-compensating flow control device • 1.8 gpm/6.8 L/min maximum flow • Durable and easy to clean brass construction • Drenching rain spray pattern gives the user a drenching shower similar to a rain downpour 		1660788.002	Polished Chrome	232
			1660788.013	Polished Nickel	324
			1660788.278	Legacy Bronze	373
			1660788.295	Brushed Nickel	324
		 			
 	Square 8-Inch 1.8 gpm/6.8 L/min Water-Saving Rain Showerhead <ul style="list-style-type: none"> • Showerhead only • Easy clean showerhead • Sleek, thin profile • Pressure-compensating flow control device • 1.8 gpm/6.8 L/min maximum flow 		1660513.075	Stainless Steel	153
					 







Body Side Sprays

Showering Options

	Description	SKU #	Color/Finish	List Price
	Extender Round Body Spray <ul style="list-style-type: none"> • Extender body sprays with 1.5 gpm/5.7 L/min maximum flow • Flush mount • Easy to clean spray face • Spray face automatically extends when water is turned on and retracts when water is off • Three functions: widespray, massage and combination • Includes exclusive rough-in that must be installed during rough-in installation and before the wall is closed • Angle adjustable. Spray position adjusts up to 15° in any direction • 1-piece installation with no loose parts to lose or reassemble on site 	1660130.002	Polished Chrome	177
		1660130.243	Matte Black	257
		1660130.295	Brushed Nickel	265
				
	Extender Square Body Spray <ul style="list-style-type: none"> • Extender body sprays with 1.5 gpm/5.7 L/min maximum flow • Flush mount • Easy to clean spray face • Spray face automatically extends when water is turned on and retracts when water is off • Three functions: widespray, massage and combination • Includes exclusive rough-in that must be installed during rough-in installation and before the wall is closed • Angle adjustable. Spray position adjusts up to 15° in any direction • 1-piece installation with no loose parts to lose or reassemble on site 	1660140.002	Polished Chrome	177
		1660140.295	Brushed Nickel	265
				

Shower Arms

Showering Options

	Description	SKU #	Color/Finish	List Price
	5-Inch Wall Mount Standard Showerhead Arm <ul style="list-style-type: none"> Fits virtually all showerheads Available in other finishes matching your other fittings 	1660240.002	Polished Chrome	29
		1660240.013	Polished Nickel	38
		1660240.243	Matte Black	43
		1660240.278	Legacy Bronze	45
		1660240.295	Brushed Nickel	38
	5-Inch Wall Mount Modern Showerhead Arm <ul style="list-style-type: none"> Brass Construction 1/2" NPT Thread For use with 1660.681, 1660.683, 1660.688 	1660241.002	Polished Chrome	30
		1660241.013	Polished Nickel	38
		1660241.243	Matte Black	45
		1660241.278	Legacy Bronze	45
		1660241.295	Brushed Nickel	41
	Townsend® Showerhead Arm and Flange <ul style="list-style-type: none"> Standard shower arm with design matching Townsend showerhead arm Recommend to be paired with the townsend collection Multiple finishes available to match showerheads and trims 	1660245.002	Polished Chrome	30
		1660245.013	Polished Nickel	41
		1660245.243	Matte Black	43
		1660245.278	Legacy Bronze	45
		1660245.295	Brushed Nickel	41
	3-Inch Ceiling Mount Rain Showerhead Arm <ul style="list-style-type: none"> Brass construction 1/2" NPT Thread Ceiling mount shower arm 	1660103.002	Polished Chrome	32
		1660103.013	Polished Nickel	46
		1660103.243	Matte Black	47
		1660103.278	Legacy Bronze	52
		1660103.295	Brushed Nickel	46
	6-Inch Ceiling Mount Rain Showerhead Arm <ul style="list-style-type: none"> Durable brass construction is ideal for prolonged contact with water Standard 1/2 in. NPT works with many different showerheads Available in other finishes matching your other fittings Easy to install 	1660186.002	Polished Chrome	46
		1660186.013	Polished Nickel	63
		1660186.243	Matte Black	66
		1660186.278	Legacy Bronze	95
		1660186.295	Brushed Nickel	63
	Rain 12-Inch Ceiling Mount Rain Showerhead Arm <ul style="list-style-type: none"> Extendable shower arm for ceiling application Durable brass construction is ideal for prolonged contact with water Standard 1/2 in. NPT works with many different showerheads Easy to install Available in other finishes matching your other fittings Extendable shower arm for ceiling application 2 1/2" ceiling flange 	1660190.002	Polished Chrome	70
		1660190.013	Polished Nickel	104
		1660190.243	Matte Black	102
		1660190.278	Legacy Bronze	127
		1660190.295	Brushed Nickel	104

















Shower Arms

Showering Options

	Description	SKU #	Color/Finish	List Price
	Rain 12-Inch Wall Mount Right Angle Rain Showerhead Arm <ul style="list-style-type: none"> • Extendable shower arm for wall mount application • Standard ½ in. NPT works with many different showerheads • Right angle bend • Fits virtually all showerheads • Available in other finishes matching your other fittings 	1660194.002	Polished Chrome	101
		1660194.013	Polished Nickel	152
		1660194.243	Matte Black	146
		1660194.278	Legacy Bronze	187
		1660194.295	Brushed Nickel	152
				
	18-Inch Wall Mount Right Angle Showerhead Arm <ul style="list-style-type: none"> • Durable brass construction is ideal for prolonged contact with water • Standard ½ in. NPT works with many different showerheads • Available in other finishes matching your other fittings 	1660118.002	Polished Chrome	127
		1660118.013	Polished Nickel	177
		1660118.243	Matte Black	184
		1660118.295	Brushed Nickel	177
				
	Rain 12-Inch Wall Mount Shepherd's Hook Rain Showerhead Arm <ul style="list-style-type: none"> • Curved showerhead arm to use with rain showerheads where ceiling mounted showerhead arms are not available • Color matching finish 	1660198.002	Polished Chrome	103
		1660198.295	Brushed Nickel	154
				









Hand Showers

Showering Options

	Description	SKU #	Color/Finish	List Price
 	Spectra® Handheld 1.8 gpm/6.8 L/min 5-Inch 4-Function Hand Shower <ul style="list-style-type: none"> • Hand shower only - requires hose and wall connection • 5" (127 mm) easy clean spray face • 4-function sprays: drench, sensitive, PowerWash® and massage • Pressure-compensating flow control device • Includes check valve • 1.8 gpm/6.8 L/min maximum flow rate 	CEC 9038154.002	Polished Chrome	99
		9038154.013	Polished Nickel	123
		9038154.243	Matte Black	143
		9038154.278	Legacy Bronze	136
		9038154.295	Brushed Nickel	123
 	Modern 2.5 gpm/9.5 L/min 3-Function Hand Shower <ul style="list-style-type: none"> • Hand shower only - requires hose and wall connection • Variable spray adjusts from a conventional spray to a gentle aerated flow to a massage action • Easy to clean spray face • Pressure-compensating flow control device • Includes check valve • 2.5 gpm/9.5 L/min maximum flow rate 	1660510.002	Polished Chrome	143
				 
 	2.5 gpm/9.5 Lpf 3-Function Hand Shower With Pause Feature <ul style="list-style-type: none"> • Pause Feature: Non-positive shut-off button on handle reduces flow to a trickle to meet ADA requirement • Pressure-compensating flow control device • Easy Clean Spray Nozzles: Allows for easy cleaning of lime and calcium build up • Includes check valve • 2.5 gpm/9.5 Lpm maximum flow rate 	ADA 1660767.002	Polished Chrome	65
				
 	1.5 gpm/5.7 Lpf 3-Function Hand Shower With Pause Feature <ul style="list-style-type: none"> • Pause Feature: Non-positive shut-off button on handle reduces flow to a trickle to meet ADA requirement • Pressure-compensating flow control device • Easy Clean Spray Nozzles: Allows for easy cleaning of lime and calcium build up • Includes check valve • 1.5 gpm/5.7 Lpm maximum flow rate 	ADA CEC 1660766.002	Polished Chrome	65
 	HydroFocus® 2.0 gpm/7.6 L/min 4-1/2-Inch 5-Function Hand Shower <ul style="list-style-type: none"> • Hand shower only - requires hose and wall connection • 4-1/2" (114 mm) easy clean face • Adjusts from massage to full/massage combination to full spray to hydrofocus concentrating spray to hydrofocus/full combination to pause • Pressure-compensating flow control device • Includes check valve • 2.0 gpm/5.6 L/min maximum flow rate • Pressure Compensating Flow Control Device provides a consistent flow over a wide pressure range • Variety of 5 Spray Patterns allows each user to select the type of spray best suited to their needs 	CEC 1660207.002	Polished Chrome	88
		1660207.295	Brushed Nickel	117
				





Hand Showers

Showering Options

	Description	SKU #	Color/Finish	List Price
	Minimalist 2.5 gpm/9.5 L/min Single Function Hand Shower <ul style="list-style-type: none"> • Single function • Easy to clean spray face • Includes check valve • 2.5 gpm/9.5 L/min maximum flow rate • Brass handle 	1660506.002	Polished Chrome	136
				
	Minimalist 1.8 gpm/6.8 L/min Single Function Water-Saving Hand Shower <ul style="list-style-type: none"> • Hand shower only - requires hose and wall connection • Single function • Easy to clean spray face • Includes check valve • 1.8 gpm/6.8 L/min maximum flow 	 1660609.002	Polished Chrome	136
		1660609.243	Matte Black	201
		1660609.295	Brushed Nickel	189
				
	Square Minimalist 1.8 gpm/6.8 L/min Single Function Water-Saving Hand Shower <ul style="list-style-type: none"> • Hand shower only - requires hose and wall connection • Single function • Easy to clean spray face • Adjusts from gentle rain to hard rain to massage • Includes check valve • 1.8 gpm/6.8 L/min maximum flow • Full spray pattern • No-clog nozzles • Does not include shower hose or holder • California Energy Commission certified 	 1660608.002	Polished Chrome	130
		1660608.295	Brushed Nickel	181
				

Slide Bar Kits

Showering Options

	Description	SKU #	Color/Finish	List Price
 	<p>Spectra® Handheld 1.8 gpm/6.8 L/min 30-Inch 4-Function Slide Bar Kit</p> <ul style="list-style-type: none"> • 4-function Spectra® Handheld (9038154) • Hose (8888035) • Wall supply (8888037) • 30" (762 mm) round slide bar (1660730) • Double check valves • 1.8 gpm/6.8 L/min maximum flow rate • Spectra® hand shower • 59" (1500 mm) shower hose 	<p>CEC</p> <p>1660774.002 1660774.243 1660774.278 1660774.295</p>	<p>Polished Chrome Matte Black Legacy Bronze Brushed Nickel</p>	<p>247 358 347 334</p>
	<p>Traditional 1.8 gpm/6.8 L/min Single Function Slide Bar Kit</p> <ul style="list-style-type: none"> • Traditional handheld shower (1660142) • Traditional slide bar (1660773) • 60" shower hose (8888035) • Wall supply (8888037) • Double check valves • 1.8 gpm/6.8 L/min maximum flow rate • Water-saving: WaterSense® certified • Pressure-compensating flow control device: Provides consistent flow over a wide pressure range • Lightweight, ergonomic design: For a sure grip even with wet, soapy hands • Simple height adjustment: Allows positioning of the personal shower anywhere along the bar 	<p>CEC</p> <p>1662607.002</p>	<p>Polished Chrome</p>	<p>432</p>
	<p>Serin® 2.5 gpm/9.5 L/min 3-Function Slide Bar Kit</p> <ul style="list-style-type: none"> • 3-function adjustable hand shower (1660510) • Hose (8888035) • Wall supply (8888037) • Slide bar • Double check valves • 2.5 gpm/9.5 L/min hand showers • Lightweight, ergonomic design: For a sure grip even with wet, soapy hands • Simple spray pattern adjustment • Simple height adjustment for slide bar 	<p>2064724.002 2064724.295</p>	<p>Polished Chrome Brushed Nickel</p>	<p>369 553</p>



Slide Bar Kits

Showering Options

	Description	SKU #	Color/Finish	List Price
	<p>1.8 gpm/6.8 L/min 30-Inch 3-Function Slide Bar Kit </p> <ul style="list-style-type: none"> • 3-function hand shower 4" (102 mm) diameter (1660147) • Hose (8888035) • Round brass wall supply • Includes double check valves • 30" (762 mm) round shower slide bar with shower bracket with round escutcheon • 1.8 gpm/6.8 L/min maximum flow rate • A wall supply with 1/2" (13 mm) NPT female inlet • 1/2" (13 mm) NPSM male outlet • 59" (1500 mm) shower hose 	1662647.002	Polished Chrome	312 

Shower System Kits

Showering Options

	Description	SKU #	Color/Finish	List Price
	<p>Commercial Shower System Trim Kit 2.5 gpm/9.5 Lpm With 36-Inch Slide Bar and Hand Shower</p> <ul style="list-style-type: none"> • For Flash® shower rough-in valves with choice of connections (sold separately) • Includes 3-function hand shower with pause feature • Pause Feature: Non-positive shut-off button on handle reduces flow to a trickle to meet ADA requirement • 36" slide bar • Metal wall escutcheon with metal lever handle. Red/blue indicator ring • 2.5 gpm/9.5 Lpm maximum flow rate 	TU662221.002	Polished Chrome	345 

Hand Shower Kits

Showering Options



Description

Spectra® Handheld 1.8 gpm/6.8 L/min 4-Function Hand Shower Kit

- 4-function Spectra® Handheld (9038154)
- Hose (8888035)
- Shower arm bracket (8888096)
- Includes check valve
- 1.8 gpm/6.8 L/min maximum flow
- AquaToggle™ easily changes sprays for hand shower
- Features a lightweight, ergonomic design for a sure grip even with wet, soapy hands
- Shower bracket attaches to all standard shower arms

SKU #



- 1660771.002
- 1660771.278
- 1660771.295

Color/Finish

- Polished Chrome
- Legacy Bronze
- Brushed Nickel













List Price

- 148
- 234
- 197



Slide Bars

Showering Options

	Description	SKU #	Color/Finish	List Price
	Round 30-Inch Shower Slide Bar	 1660730.002	Polished Chrome	99
	<ul style="list-style-type: none"> • Adjustable gliding bracket for personal showers • Adjustable shower holder • Slide bars for hands free showering • Adjustable setting for any height • Available in four different finishes 	1660730.013	Polished Nickel	123
	1660730.243	Matte Black	143	
	1660730.278	Legacy Bronze	136	
	1660730.295	Brushed Nickel	123	
 				
	Traditional 30-Inch Shower Slide Bar	1660773.002	Polished Chrome	174
	<ul style="list-style-type: none"> • Adjustable bracket for personal showers • Adjustable shower holder can be set at any height or position along the bar and angles up to 45 degrees 	1660773.013	Polished Nickel	242
	1660773.278	Legacy Bronze	261	
	1660773.295	Brushed Nickel	242	
 				
	Standard 24-Inch Shower Slide Bar	1660225.002	Polished Chrome	144
	<ul style="list-style-type: none"> • Adjustable bracket for personal showers • Adjustable shower holder can be set at any height or position along the bar and angles up to 45 degrees 	1660225.295	Brushed Nickel	215
 				
	Standard 36-Inch Shower Slide Bar	1660236.002	Polished Chrome	156
<ul style="list-style-type: none"> • Adjustable bracket for personal showers • Adjustable shower holder can be set at any height or position along the bar and angles up to 45 degrees 				
 				

Slide Bars

Showering Options

	Description	SKU #	Color/Finish	List Price
	<p>Square 30-Inch Shower Slide Bar</p> <ul style="list-style-type: none"> • Adjustable bracket for personal showers • Matching square wall brackets • Durable brass construction is ideal for prolonged contact with water • Standard 1/2" (13 mm) NPT works with many different showerheads • Right angle bend • Fits virtually all showerheads • Available in other finishes matching your other fittings 	1660230.002	Polished Chrome	290













	<p>Round 30-Inch Shower Slide Bar</p> <ul style="list-style-type: none"> • Adjustable bracket for personal showers • Round wall flange 	1660330.002	Polished Chrome	183
--	---	-------------	-----------------	-----









Shower System Accessories

Showering Options

	Description	SKU #	Color/Finish	List Price	
	Metal Shower Hose <ul style="list-style-type: none"> • 59" (1499 mm) long • Compatible with all personal showers • Limited Lifetime warranty - function & finish • Not recommended to be used as an extension hose 	8888035.002	Polished Chrome	70	
		8888035.013	Polished Nickel	98	
		8888035.243	Matte Black	104	
		8888035.278	Legacy Bronze	104	
		8888035.295	Brushed Nickel	98	
					
	Metal Shower Hose <ul style="list-style-type: none"> • 79" (2006 mm) long • Compatible with all personal showers • Limited Lifetime warranty - function & finish 	8888053.002	Polished Chrome	83	
	1/2-Inch NPT In-Line Vacuum Breaker <ul style="list-style-type: none"> • Attaches between supply outlet and personal shower hose • Durable brass construction is ideal for prolonged contact with water • Polished chrome finish for a stylish appearance • Standard 1/2" (13 mm) NPT connection • Compatible with all personal showers • Limited Lifetime warranty - function & finish 	1660400.002	Polished Chrome	51	
		1660400.013	Polished Nickel	70	
		1660400.243	Matte Black	74	
		1660400.278	Legacy Bronze	82	
		1660400.295	Brushed Nickel	70	
					
	Shower Arm Bracket <ul style="list-style-type: none"> • Angle adjustable • Metal ball joint • 1/2" (13 mm) NPT • Includes check valve • 1/2" (13 mm) NPSM male hose thread • Square brass elbow 	8888096.002	Polished Chrome	24	
		8888096.013	Polished Nickel	33	
		8888096.243	Matte Black	35	
		8888096.278	Legacy Bronze	38	
		8888096.295	Brushed Nickel	33	
					
	Fixed Wall Bracket <ul style="list-style-type: none"> • For use with personal showers • Fixed wall bracket • American Standard - style that works better 	8888036.002	Polished Chrome	31	
		8888036.013	Polished Nickel	43	
		8888036.243	Matte Black	46	
		8888036.278	Legacy Bronze	46	
		8888036.295	Brushed Nickel	43	
					
	Wall Supply <ul style="list-style-type: none"> • 1/2" (13 mm) female thread NPT • 1/2" (13 mm) NPSM male hose thread • Includes check valve • Durable cast brass construction - Excellent for high use applications with prolonged water use • Limited Lifetime warranty on function and finish 	8888037.002	Polished Chrome	49	
		8888037.013	Polished Nickel	68	
		8888037.243	Matte Black	74	
		8888037.278	Legacy Bronze	74	
		8888037.295	Brushed Nickel	68	
					



















Shower System Accessories

Showering Options

	Description	SKU #	Color/Finish	List Price
	Round Wall Supply	8888068.002	Polished Chrome	61
	• ½" (13 mm) female thread NPT	8888068.243	Matte Black	92
	• ½" (13 mm) NPSM male hose thread	8888068.295	Brushed Nickel	86
	<ul style="list-style-type: none"> • Includes check valve • Round wall supply • Pattern can be changed with the flick of the thumb: 2.0 gpm/7.6 L/min flow restrictor 			
	Square Wall Supply	8888069.002	Polished Chrome	88
	• ½" (13 mm) female thread NPT	8888069.013	Polished Nickel	125
	• ½" (13 mm) NPSM male hose thread	8888069.295	Brushed Nickel	125
	<ul style="list-style-type: none"> • Includes check valve • Square brass elbow 			
	Wall Supply Bracket	8888038.002	Polished Chrome	85
	• ½" (13 mm) female thread NPT	8888038.295	Brushed Nickel	127
	<ul style="list-style-type: none"> • ½" (13 mm) NPSM male hose thread • Includes check valve • Integral bracket holds the hand shower at a convenient angle 			













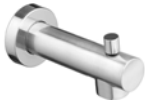







Tub Spouts

Showering Options

	Description	SKU #	Color/Finish	List Price
	Delancey® 8-1/8-Inch Slip-On Diverter Tub Spout • For ½" (13 mm) copper pipe • 8-1/8" (207 mm) length to center of spout outlet • Slip-On connection • All metal construction	8888105.002	Polished Chrome	109
		8888105.013	Polished Nickel	154
		8888105.278	Legacy Bronze	165
		8888105.295	Brushed Nickel	154
 				
	Delancey® 8-1/8-Inch IPS Diverter Tub Spout • For ½" (13 mm) IPS connection • 8-1/8" (207 mm) length to center of spout outlet • IPS connection • All metal construction	8888104.002	Polished Chrome	109
		8888104.013	Polished Nickel	154
		8888104.278	Legacy Bronze	165
		8888104.295	Brushed Nickel	154
 				
	Delancey® 8-1/8-Inch Slip-On Non-Diverter Tub Spout • For ½" (13 mm) copper pipe • 8-1/8" (207 mm) length to center of spout outlet • Slip-On connection • All metal construction	8888107.002	Polished Chrome	99
		8888107.013	Polished Nickel	138
		8888107.278	Legacy Bronze	148
		8888107.295	Brushed Nickel	138
 				
	Delancey® 8-1/8-Inch IPS Non-Diverter Tub Spout • For ½" (13 mm) IPS connection • 8-1/8" (207 mm) length to center of spout outlet • IPS connection • All metal construction	8888106.002	Polished Chrome	99
		8888106.013	Polished Nickel	138
		8888106.278	Legacy Bronze	148
		8888106.295	Brushed Nickel	138
 				
	Deluxe 4-Inch Diverter Tub Spout • ½" (13 mm) IPS connection • 4" length to center of stream straightener • All metal construction	8888055.002	Polished Chrome	49
		8888055.295	Brushed Nickel	68
	Deluxe 5-1/8-Inch Diverter Tub Spout • ½" (13 mm) IPS connection • 5-1/8" length to center of stream straightener • All metal construction	8888022.002	Polished Chrome	114
 				
	Fluent® 6-1/2-Inch Slip-On Diverter Tub Spout • For ½" (13 mm) copper pipe • 6-½" (165 mm) length to center of spout outlet	8888009.002	Polished Chrome	98
 				



















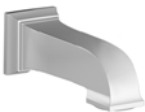

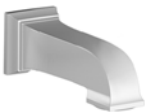
Tub Spouts

Showering Options

	Description	SKU #	Color/Finish	List Price
	Serin® 6-3/4-Inch Brass Tub Spout <ul style="list-style-type: none"> • 1/2" (13 mm) IPS connection • 6-3/4" (171 mm) length to center of spout outlet • All metal construction 	8888421.002	Polished Chrome	130
				 
	Serin® 4-7/8-Inch Slip-On Diverter Tub Spout <ul style="list-style-type: none"> • For 1/2" (13 mm) copper pipe • 4-7/8" (124 mm) length to center of spout outlet • All metal construction 	8888087.002	Polished Chrome	100
				 
	Slip-On Non-Diverter Tub Spout <ul style="list-style-type: none"> • For 1/2" (13 mm) copper pipe • All metal construction 	8888056.002	Polished Chrome	38
	4-Inch Slip-On Diverter Tub Spout <ul style="list-style-type: none"> • For 1/2" (13 mm) copper pipe • All metal construction 	8888026.002	Polished Chrome	38
	Studio® S 6-Inch Slip-On Diverter Tub Spout <ul style="list-style-type: none"> • For 1/2" (13 mm) copper pipe • 6" (152 mm) length to center of spout outlet • Metal construction 	 8888318.002 8888318.243 8888318.295	Polished Chrome Matte Black Brushed Nickel	100 149 139
				 
	Studio® S 6-Inch IPS Diverter Tub Spout <ul style="list-style-type: none"> • 1/2" (13 mm) IPS connection • 6" (152 mm) length to center of spout outlet • Metal construction 	 8888319.002 8888319.243 8888319.295	Polished Chrome Matte Black Brushed Nickel	100 149 139
				 
	Studio® S 6-Inch Slip-On Non-Diverter Tub Spout <ul style="list-style-type: none"> • For 1/2" (13 mm) copper pipe • 6" (152 mm) length to center of spout outlet • Metal construction 	8888316.002 8888316.243 8888316.295	Polished Chrome Matte Black Brushed Nickel	93 140 130
				 
	Studio® S 6-Inch IPS Non-Diverter Tub Spout <ul style="list-style-type: none"> • 1/2" (13 mm) IPS connection • 6" (152 mm) length to center of spout outlet • Metal construction 	8888317.002 8888317.243 8888317.295	Polished Chrome Matte Black Brushed Nickel	93 140 130
				 







Tub Spouts

Showering Options

	Description	SKU #	Color/Finish	List Price
	Town Square® S 6-3/4-Inch Slip-On Diverter Tub Spout <ul style="list-style-type: none"> • For 1/2" (13 mm) copper pipe • 6-3/4" (171 mm) length to center of outlet • All metal construction 	 8888109.002	Polished Chrome	125
		8888109.013	Polished Nickel	175
		8888109.278	Legacy Bronze	188
		8888109.295	Brushed Nickel	175
		 		
	Town Square® S 6-3/4-Inch IPS Diverter Tub Spout <ul style="list-style-type: none"> • 1/2" (13 mm) IPS connection • 6-3/4" (171 mm) length to center of outlet • All metal construction 	 8888108.002	Polished Chrome	125
		8888108.013	Polished Nickel	175
		8888108.278	Legacy Bronze	188
		8888108.295	Brushed Nickel	175
		 		
	Town Square® S 6-3/4-Inch Slip-On Non-Diverter Tub Spout <ul style="list-style-type: none"> • For 1/2" (13 mm) copper pipe • 6-3/4" (171 mm) length to center of outlet • All metal construction 	8888111.002	Polished Chrome	112
		8888111.013	Polished Nickel	157
		8888111.278	Legacy Bronze	170
		8888111.295	Brushed Nickel	157
		 		
	Town Square® S 6-3/4-Inch IPS Non-Diverter Tub Spout <ul style="list-style-type: none"> • 1/2" (13 mm) IPS connection • 6-3/4" (171 mm) length to center of outlet • All metal construction 	8888110.002	Polished Chrome	112
		8888110.013	Polished Nickel	157
		8888110.278	Legacy Bronze	170
		8888110.295	Brushed Nickel	157
		 		
	Townsend® 6-1/2-Inch Slip-On Diverter Tub Spout <ul style="list-style-type: none"> • For 1/2" (13 mm) copper pipe • 6-1/2" (165 mm) length to center of spout outlet • All metal construction 	 8888093.002	Polished Chrome	96
		8888093.013	Polished Nickel	135
		8888093.243	Matte Black	140
		8888093.278	Legacy Bronze	144
		8888093.295	Brushed Nickel	135
 				
	Townsend® 6-1/2-Inch IPS Diverter Tub Spout <ul style="list-style-type: none"> • 1/2" (13 mm) IPS connection • 6-1/2" (165 mm) length to center of spout outlet • All metal construction 	 8888098.002	Polished Chrome	96
		8888098.013	Polished Nickel	135
		8888098.278	Legacy Bronze	144
		8888098.295	Brushed Nickel	135
		 		







Drains and P-Traps

Parts

	Description	ADA	SKU #	Color/Finish	List Price
	Push Pop-up Drain With Overflow • 1-1/4" (32 mm) tailpiece		8888095.002	Polished Chrome	58
			8888095.013	Polished Nickel	82
			8888095.278	Legacy Bronze	87
			8888095.295	Brushed Nickel	82
	Push Pop-up Drain Without Overflow • 1-1/4" (32 mm) tailpiece		8888112.002	Polished Chrome	58
			8888112.013	Polished Nickel	82
			8888112.278	Legacy Bronze	87
			8888112.295	Brushed Nickel	82
	Drain Tailpiece • 1-1/4" (32 mm) diameter • Compatible with all American Standard drains		8888113.002	Polished Chrome	32
			8888113.013	Polished Nickel	33
			8888113.278	Legacy Bronze	35
			8888113.295	Brushed Nickel	33
	Decorative P-Trap • 1-1/4" (32 mm) diameter slip fit inlet • Brass construction • Removable trap eye for easy cleaning		8888114.002	Polished Chrome	201
			8888114.013	Polished Nickel	283
			8888114.278	Legacy Bronze	304
			8888114.295	Brushed Nickel	283
	Decorative P-Trap • Fully plated drain with 17 gauge tube • 1-1/4" x 1-1/4" (32 x 32 mm) trap with 9" (229 mm) drain tube • Includes flange and reducer seal to attach 1-1/4" (32 mm) drain tube to 1-1/2" (38 mm) wall drain • IAPMO (UPC) Approved • Fits most standard bathroom sinks • No special tools required for installation		7720018.002	Polished Chrome	133
			7720018.295	Brushed Nickel	186



Lavatory Faucets

Parts

	Description	SKU #	Color/Finish	List Price
	1.5 gpm/5.7 L/ min Pressure-Compensating Vandal-Resistant Aerator With Key <ul style="list-style-type: none"> • 15/16" (8 mm) male threads • 1.5 gpm/5.7 L/min maximum • Available in Chrome • Includes aerated spray and key 	M922887-0020A	Polished Chrome	19
		M922887-2950A	Brushed Nickel	19
	1.5 gpm/5.7 L/min Pressure-Compensating Vandal-Resistant Aerator With Key <ul style="list-style-type: none"> • 55/64" (21 mm) female threads • 1.5 gpm/5.7 L/min maximum • Available in Chrome • Includes aerated spray and key 	M922888-0020A	Polished Chrome	17
	1.0 gpm/3.8 L/min Pressure-Compensating Aerator <ul style="list-style-type: none"> • 15/16" (24 mm) male threads • 1.0 gpm/3.8 L/min maximum • Specify color when ordering • Includes aerated spray 	M922991-0020A	Polished Chrome	8
	1.0 gpm/3.8 L/min Pressure-Compensating Aerator <ul style="list-style-type: none"> • 55/64" (21 mm) female threads • 1.0 gpm/3.8 L/min maximum • Available in Chrome • Includes aerated spray 	M922992-0020A	Polished Chrome	8
	1.0 gpm/3.8 L/min Pressure-Compensating Vandal-Resistant Aerator With Key <ul style="list-style-type: none"> • For use on metering lavatory faucet series 1340 including pillar tap • 15/16" (24 mm) male threads • 1.0 gpm/3.8 L/min maximum • Available in Chrome • Includes aerated spray and key 	M922996-0020A	Polished Chrome	19
	1.0 gpm/3.8 L/min Pressure-Compensating Vandal-Resistant Aerator With Key <ul style="list-style-type: none"> • For use on metering spread and center set lavatory faucet series 1340 • 55/64" (21 mm) female threads • 1.0 gpm/3.8 L/min maximum • Available in Chrome • Includes aerated spray and key 	M922997-0020A	Polished Chrome	19
	0.5 gpm/1.9 L/min Pressure-Compensating Non-Aerated Spray <ul style="list-style-type: none"> • 15/16" (24 mm) male threads • 0.5 gpm/1.9 L/min maximum • Available in Chrome • Includes non-aerated spray 	M922901-0020A	Polished Chrome	10
				







Lavatory Faucets

Parts

	Description	SKU #	Color/Finish	List Price
	<p>0.5 gpm/1.9 L/min Pressure-Compensating Non-Aerated Spray</p> <ul style="list-style-type: none"> • 55/64" (21 mm) female threads • 0.5 gpm/1.9 L/min maximum • Available in Chrome • Includes non-aerated spray 	M922903-0020A	Polished Chrome	11
	<p>0.5 gpm Non-Aerated Spray With Key</p> <ul style="list-style-type: none"> • For use on 605X, 2506 & 250B, 5500, 6500, 7295, 1340 series faucets • Vandal resistant • 15/16" (24 mm) male threads • 0.5 gpm/1.9 L/min maximum • Available in Chrome • Includes non-aerated spray and key 	066508-0020A	Polished Chrome	19
	<p>0.5 gpm Non-Aerated Spray</p> <ul style="list-style-type: none"> • For use on 6500, 6502, 6503, 6532 series spread lavatory faucets • Vandal-resistant • 55/64" (21 mm) female threads • 0.5 gpm/1.9 L/min maximum • Available in Chrome 	066074-0020A	Polished Chrome	19





Flash® Rough-In Valves

Parts

	Description	SKU #	Color/Finish	List Price
	<p>Flat Aerator Kit</p> <ul style="list-style-type: none"> • For single control pressure balance bath/showers • For all trim kits used in conjunction with R116SS or R126SS • Includes hardware to provide an additional 3/4" (19 mm) rough-in depth 	M962818-0070A	No Finish	32
	<p>Extension Kit</p> <ul style="list-style-type: none"> • Extends shank 2-1/4" (57 mm) • For use on 4" centersets with 1/2" (13 mm) male inlet shanks • For use on top mount kitchens with 1/2" (13 mm) male inlet shanks • For use on 4" center-set faucets with 1/2" male inlet shanks and top mount faucets with 1/2" (13 mm) male inlet shanks • Includes 2 extensions 	M960131-0070A	No Finish	42
	<p>Deep Rough-in Kit for Pressure Balance Valve</p> <ul style="list-style-type: none"> • For All TU series pressure balance valve trim kits used in conjunction with Flash® shower rough-in valves • Provides additional 3/4" (19 mm) rough-in depth • Includes two 4" (102 mm) screws for trim kit installation and handle adaptor screw • Specify color when ordering 	M970649-0020A	Polished Chrome	43
	<p>Pressure Balance Cartridge for Flash®</p> <ul style="list-style-type: none"> • Suitable for both standard installation & BTB solution • Includes removal ring to aid in removal of cartridge from valve 	M970654-0070A	No Finish	37
	<p>Removal Ring</p> <ul style="list-style-type: none"> • Aids in removing cartridge from valve 	M970648-0070A	No Finish	7
	<p>Retaining Ring</p> <ul style="list-style-type: none"> • For use with all Flash® shower rough-in valves • Secure cartridges/test cap to valve body • Made of stainless steel 	M970452-0070A	No Finish	11
	<p>Service Stops</p> <ul style="list-style-type: none"> • For use with all Flash® shower rough-in valves • Set of two 	M970451-0070A	No Finish	15

Flash® Rough-In Valves

Parts

	Description	SKU #	Color/Finish	List Price
	<p>Flush Plug Assembly</p> <ul style="list-style-type: none"> • Two way flush plug assembly 	M970545-0070A	No Finish	11
	<p>Conversion Kit for TRIMendous® Trim Kits</p> <ul style="list-style-type: none"> • Converts TRIMendous® trim kits to work with all Flash® shower rough-in valves • For use with the following T series trim kits: Berwick®, Colony® PRO , Edgemere®, Fluent®, Patience®, Serin®, Studio® S, Times Square®, Town Square® S, Townsend® • NOT for use with the following TRIMendous® trim kits: Portsmouth®, Quentin®, Reliant 3®, Town Square® (T555520 series), Colony Soft®, Seva®, Studio • Available in Chrome 	M970645-0070A	No Finish	83
	<p>Locking Cam Screw Set</p> <ul style="list-style-type: none"> • For use with all Flash® shower rough-in valves • Used for thin wall applications • Set of two 	M970453-0070A	No Finish	11
	<p>Cartridge Removal Tool</p> <ul style="list-style-type: none"> • Universal cartridge removal tool for shower valves 	M970652-0070A	No Finish	57

Cartridges and Rough-In Kits

Parts

	Description	SKU #	Color/Finish	List Price
	Temperature Control Pressure Balance Valve Cartridge <ul style="list-style-type: none"> • For bath/shower pressure balance valves • Ships standard with R111 series valves • Protects against scalding 	A954440-0070AP	No Finish	39
		A954440-0070A	No Finish	42
	Volume and Temperature Control Pressure Balance Valve Cartridge <ul style="list-style-type: none"> • For bath/shower pressure balance valves • Ships standard with R121 series valves 	023529-0070A/H	No Finish	25
		023529-0070A	No Finish	29
		023529-0070AP	No Finish	25
	Back-to-Back Volume and Temperature Control Pressure Balance Valve Cartridge <ul style="list-style-type: none"> • For use in back-to-back installations to reverse hot and cold lines without removing R121 series rough valve body • For bath/shower pressure balance valves 	952377-0070A	No Finish	31
	Temperature Control Pressure Balance Valve Cartridge <ul style="list-style-type: none"> • For use on R110, R120, R115, R125 rough-in valves • Ships standard with R111/R121 series valves • Protects against scalding 	M952100-0070A/H	No Finish	27
		M952100-0070AP	No Finish	33
		M952100-0070A	No Finish	34
	Flash® 2-Way Shared Diverter Cartridge <ul style="list-style-type: none"> • For use with RU521 valve 	M970720-0070A	No Finish	79
	Flash® 3-Way Shared Diverter Cartridge <ul style="list-style-type: none"> • For use with RU531 valve 	M970730-0070A	No Finish	79
	Modernization Plate <ul style="list-style-type: none"> • For all trim kits used in conjunction with RU series valves • Metal construction for durability • Specify color when ordering 	★ M961819-0020A	Polished Chrome	72

Cartridges and Rough-In Kits

Parts

	Description	SKU #	Color/Finish	List Price
	Deep Rough-In Kit <ul style="list-style-type: none"> • For single control pressure balance bath/showers • For all trim kits used in conjunction with R111 or R121 series valves • Includes hardware to provide an additional 3/4" (19 mm) rough-in depth • Specify color when ordering 	M961818-0020A	Polished Chrome	42
		M961818-2950A	Brushed Nickel	45
	Deep Rough-In Kit <ul style="list-style-type: none"> • For use with Cadet 3275 series 2-handle bath/shower (metal lever handle) • Includes hardware to provide an additional 3/4" (19 mm) rough-in depth • No finish • Kit includes two extension nuts, two handle adapter extensions and two 8-18 x 1/2 phillips pan head screws 	M962262-0070A	No Finish	35
	Deep Rough-In Kit <ul style="list-style-type: none"> • For use with Cadet 3375 series 3-handle bath/shower (metal lever handle) • Includes hardware to provide an additional 3/4" (19 mm) rough-in depth • No finish • Kit includes two extension nuts, three handle adapter extensions, three 8-18 x 1/2 phillips pan head screws and 1 valve nut extension 	M962263-0070A	No Finish	99
	Thermostat and Volume Control Valve Deep Rough-In Kit <ul style="list-style-type: none"> • For use with R510, R520, R531 RU521 and RU531 series valves • Maximum 3/4" (19 mm) extension • Available in Chrome • Kit includes deep rough-in and hex key 	963434-0020A	Polished Chrome	151
	R700 Series Thermostat and Volume Control Valve Deep Rough-In Kit <ul style="list-style-type: none"> • For use with R701 and R711 series on/off volume control valves • Maximum 3/4" (19 mm) extension • Brass construction for durability 	066078-0070A	No Finish	86
	Diverter Extension Kit <ul style="list-style-type: none"> • For use with R422 and R433 valves, shared and discrete • Maximum 3/4" (19 mm) extension • Specify color when ordering • Kit includes spindle, escutcheon and spring clip 	963554-0020A	Polished Chrome	42
		963554-2950A	Brushed Nickel	50

Faucet Modifications – How to Order

ORDERING

- Special Manufacturing or Modification requests can be made through your sales rep or customer care
- You will need to provide basic information regarding the request for review by category and manufacturing teams

PRICING

- Pricing will be provided by sales rep after review of request

CONDITIONS

- Some modifications may not be feasible. Each request will be reviewed by category and manufacturing
- Order minimum: 100 pieces. Exceptions will be considered on large job quotes
- A one-time setup charge may be applied to modification

Faucet Aerator Cross Reference – Kitchen Faucet Aerators

- Select the appropriate aerator for your faucet using these aerator cross reference charts.

Name	Series	Available Finishes	Aerator Type	1.5 gpm (5.7 L/min)
Beale®	4931.002	002, 075	N/A	N/A
Colony® PRO	7074	002, 075	N/A	N/A
Delancey®	4279.300/400/701	002, 013, 075, 278	N/A	N/A
	4279.410		Male	M922917
Edgewater®	4932	002, 075	N/A	N/A
Reliant+®	4205.00x	002	Male	M922887
	4205.104	002, 075	N/A	N/A
Studio® S	4803100	002, 075, 243	Male	N/A
	4803300/350			N/A
	4803410			M922909
	4803900			N/A

Additional modifications available.

Faucet Aerator Cross Reference – Lavatory Faucet Aerators

- Select the appropriate aerator for your faucet using these aerator cross reference charts.

Name	Series	Aerator Type	Available Finishes	0.5 gpm (1.9 L/min) PCA Spray	0.5 gpm (1.9 L/min) Vandal-Resistant PCA Spray	1.0 gpm (3.8 L/min) PCA Aerator	1.0 gpm (3.8 L/min) Vandal-Resistant PCA Aerator	1.2 gpm (4.5 L/min) Vandal-Resistant PCA Aerator
Colony® PRO	7075.0XX	Slim	Plain, no finish	N/A	M922917	N/A	N/A	N/A
	7075.1XX/80X			N/A	M922917	N/A	N/A	N/A
	7075.20X			N/A	N/A	M923845	N/A	N/A
Delancey®	7052.107/2X7/8X7	Slim	Plain, no finish	N/A	N/A	M923845	N/A	N/A
Fluent®	7186.2XX/8XX	Slim	Plain, no finish	N/A	M922917	N/A	N/A	N/A
	7186.10X	N/A	N/A	N/A	N/A	N/A	N/A	N/A
Reliant 3®	7385	Regular Male	002, 295	M922901	066508	M922991	M922996	M923811
Serin®	2064.101/151/152	Regular Male	002, 295	M922901	066508	M922991	M922996	M922811
	2064.13X			M922901	N/A	M922991	N/A	N/A
	2064.451/461	Caché Thumb	Plain, no finish	N/A	N/A	M922998	M922998	N/A
	2064.8XX	N/A	N/A	N/A	N/A	N/A	N/A	N/A
Studio® S	7105.10X/152/8X7	Regular Male	002, 295	N/A	N/A	M923845	N/A	N/A
	7105.80X/82X			N/A	N/A	N/A	N/A	N/A
Town Square® S	7455	Regular Male	002, 013, 278, 295	M922901	N/A	M922991	N/A	N/A
Townsend®	7353	Slim	Plain, no finish	N/A	N/A	M923845	N/A	N/A

Faucet Modifications

Finishes: 0020A Polished Chrome -0750A Stainless Steel -2780A Legacy Bronze N/A Not Available
 -0130A Polished Nickel -2240A Oil Rubbed Bronze -2950A Brushed Nickel

All residential faucets shipped with 1.2 gpm (4.5 L/min) standard aerator.
 Additional modifications available.

Warranties

American Standard product warranty information is available online by visiting:
americanstandard.com/warranty or scan the **QR code** below.



Colony[®]3 Two-Piece Toilet



American Standard

LIFE.LOVE.HOME

Colony® PRO Pull-Down Kitchen Faucet



Related Literature



2023 Commercial Fittings and Fixtures List Price Guide



2023 LIXIL Builder Advantage Program Brochure



2023 AS Distributor Support Programs Brochure

For American Standard Customer Care

Call 1-800-442-1902 - Monday - Friday, 8:00 am - 7:00 pm EST

Visit www.Americanstandard.com

Front Cover: AquaWash® Slim Non-Electric SpaLet® Bidet Seat With Manual Operation

Inside Back Cover: Colony®3 Two-Piece 1.28 gpf/4.8 Lpf Chair Height Elongated Toilet

Back Cover: Colony® PRO Single Handle Pull-Down Kitchen Faucet